

HIFI FILTER®

VOTRE PARTENAIRE EN FILTRATION
YOUR PARTNER IN FILTRATION
IHR FILTRATION PARTNER



**REMONTÉES MÉCANIQUES
SKI LIFTS
SKIPISTENBEARBEITUNG**

www.hifi-filter.com

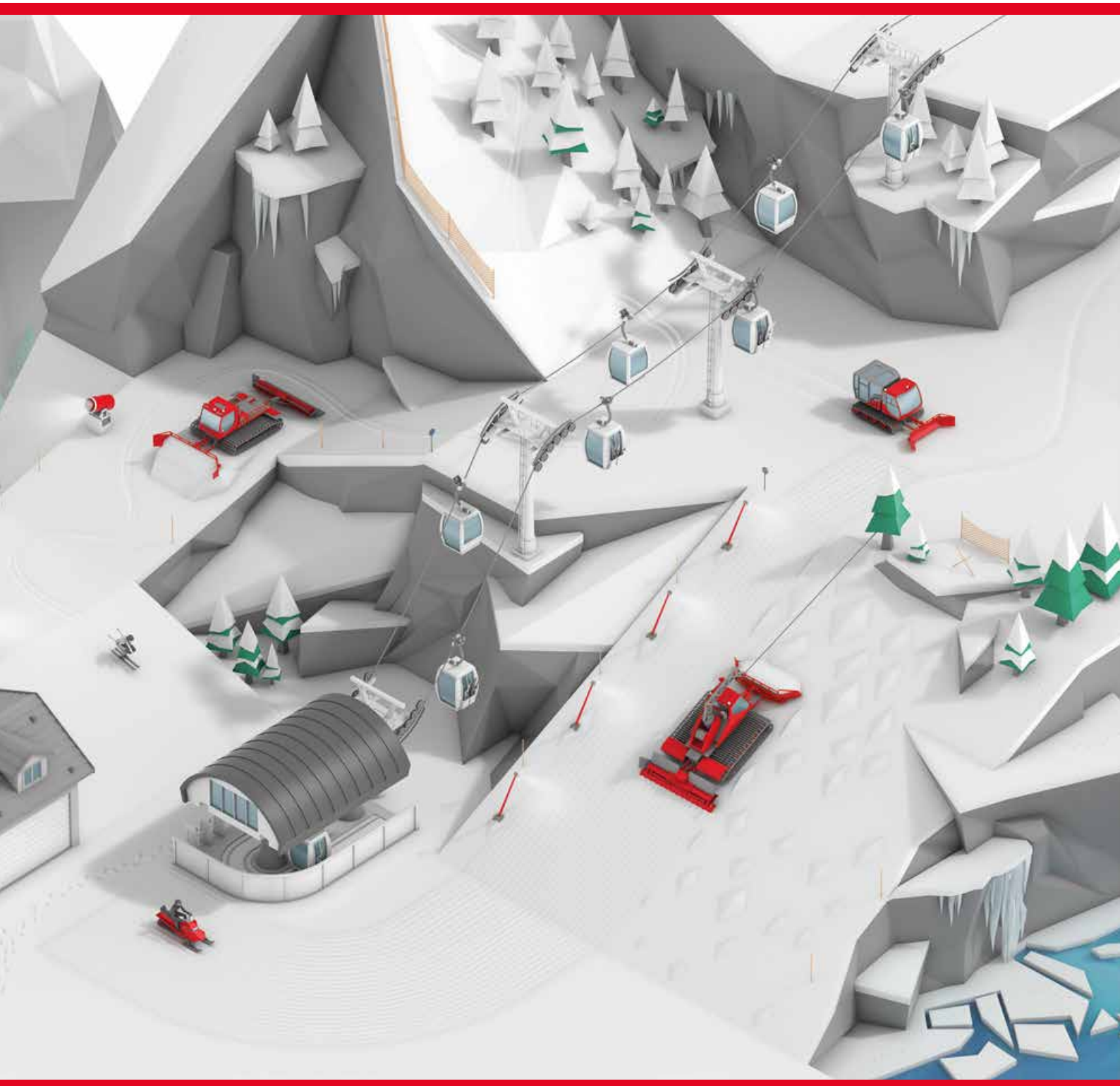

APPLICATIONS

APPLICATIONS | ANWENDUNGEN



DAMEUSES

SNOW-GROOMING MACHINES | PISTENBULLY

11



MOTONEIGES - QUADS

SNOWMOBILE - ATV | SCHNEEMOBIL - QUADS

41



ENNEIGEMENT ARTIFICIEL

ARTIFICIAL SNOW | KUNSTSCHNEE



CANONS À NEIGE

SNOW CANNONS | SCHNEEKANONEN

101



AIR COMPRIMÉ

COMPRESSED AIR | DRUCKLUFT

109



AÉRAULIQUE

HVAC | KLIMA UND BELÜFTUNG

125



MOTEUR & ENVIRONNEMENT MATÉRIEL

ENGINE & EQUIPMENT ENVIRONMENT | MOTOR UND ZUSATZPRODUKTE



MOTEUR

ENGINE | MOTOR

133



HYDRAULIQUE

HYDRAULIC | HYDRAULIK

147



DISTRIBUTION CARBURANT

FUEL DISPENSING | KRAFTSTOFFBETANKUNG

153



FREINAGE

BRAKING | BREMSEN

161



PRODUITS COMPLÉMENTAIRES

ADDITIONAL PRODUCTS | ZUSATZPRODUKTE

165



INFORMATIONS & INDEX

INFORMATION & INDEX | INFORMATIONEN UND INDEX

171





MOBILE

MOBILE - MOBIL



HIFI FILTER, le leader des filtres compatibles.
HIFI FILTER, the leader in compatible filters.
HIFI FILTER, der Marktführer für kompatible Filter.

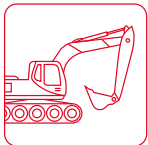

Construction

Construction equipment
Baumaschinen



Marine

Marine
Marine



Manutention

Handling equipment
Gabelstapler und Hebetchnik

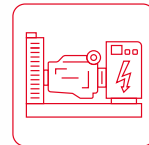

Groupes électrogènes

Power generators
Stromaggregate

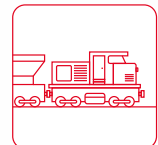

Ferroviaire

Rail
Bahn



Agricole

Agriculture
Landwirtschaft



Forestier

Forest
Holzernte

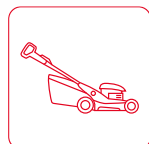

Espaces verts

Parks & Golf
Golf und Gartentechnik



Remontées mécaniques

Ski lifts
Skipistenbearbeitung

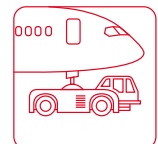

Équipement d'aéroport

GSE (Ground Support Equipment)
Ausrüstung für die Bodenabfertigung



Poids lourds / Bus

Trucks / Buses
LKW / Busse

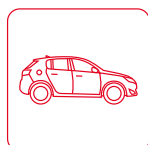

Automobile

Passenger vehicles
PKW

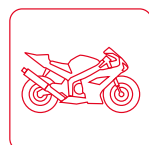

Motos - Quads

Motorcycles - ATV
Motorräder - Quads

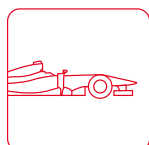

Hautes performances

High performance
Hochleistung



INDUSTRIE

INDUSTRY - INDUSTRIE



HIFI FILTER, le leader des filtres compatibles.
HIFI FILTER, the leader in compatible filters.
HIFI FILTER, der Marktführer für kompatible Filter.

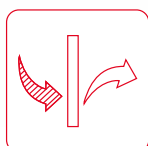

Aéraulique
 HVAC
 Klima und Belüftung

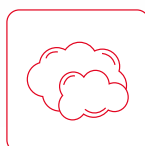

Dépoussiérage
 Dust extraction
 Entstaubung

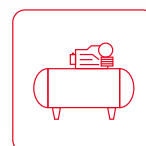

Air comprimé
 Compressed air
 Druckluft

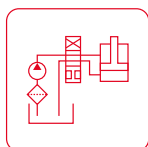

Hydraulique
 Hydraulics
 Hydraulik

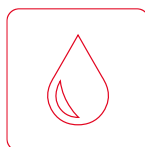

Liquides
 Liquids
 Flüssigkeiten

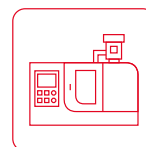

Machines outils
 Machine tools
 Werkzeugmaschinen



**FILTRATION
FILTRATION
FILTRATION**

- ▶ Filtration adaptée à vos besoins
 - ▶ Gamme complète et diversifiée
 - ▶ Une seule marque, un seul fournisseur
-
- ▶ Filtration for your needs
 - ▶ Complete and diversified range
 - ▶ One stop filter shop
-
- ▶ Filter für Ihre Anwendungen
 - ▶ Komplettes und breites Sortiment
 - ▶ Alle Filter aus einer Hand



**STOCK ET DISPONIBILITÉ
STOCK AND AVAILABILITY
LAGER UND VERFÜGBARKEIT**

- ▶ 41 000 m² de stockage
 - ▶ 30 000 références stockées
 - ▶ 120 pays desservis
-
- ▶ 41 000 m² of storage facilities
 - ▶ 30 000 references in stock
 - ▶ Distributed in 120 countries
-
- ▶ 41 000 m² Lager
 - ▶ 30 000 Referenzen vorrätig
 - ▶ Vertrieb in 120 Länder



**QUALITÉ
QUALITY
QUALITÄT**

- ▶ Qualité certifiée HIFI FILTER®
 - ▶ Laboratoire de contrôles et d'analyses
 - ▶ Garantie produit
-
- ▶ Certified HIFI FILTER® quality
 - ▶ Analysis and control laboratory
 - ▶ Product warranty
-
- ▶ Zertifizierte HIFI FILTER® Qualität
 - ▶ Analyse und Kontrolllabor
 - ▶ Produktgarantie



**OPTIMISEZ
OPTIMIZE
OPTIMIEREN**



**ÉCONOMISEZ
SAVE
SPAREN**



**GAGNEZ
WIN
GEWINNEN**



**SERVICES
SERVICES
SERVICES**

- ▶ Services client sur mesure
 - ▶ Conseil technique et suivi sur site
 - ▶ Solutions informatiques personnalisées
-
- ▶ Tailored customer service
 - ▶ Technical advise and on-site help
 - ▶ Customized IT solutions
-
- ▶ Kundenservice
 - ▶ Technische Beratung und Vor-Ort-Hilfe
 - ▶ Kundenspezifische IT Lösungen



**SUPPORTS
SUPPORT
UNTERSTÜTZUNG**

- ▶ Recherches par applications et équivalences
 - ▶ Outils simples et intuitifs
 - ▶ Informations actualisées
-
- ▶ Search by applications and cross-references
 - ▶ Easy and intuitive tools
 - ▶ Up to date information
-
- ▶ Suche nach Anwendung und Vergleich
 - ▶ Einfache und intuitive Werkzeuge
 - ▶ Aktuelle Informationen



HIFI FILTER®

- ▶ Au service de nos clients depuis 1977
 - ▶ 500 collaborateurs
 - ▶ 30 000 entreprises nous font confiance
-
- ▶ Serving our customers since 1977
 - ▶ 500 coworkers
 - ▶ 30 000 companies trust us
-
- ▶ Im Dienste unserer Kunden seit 1977
 - ▶ 500 Mitarbeiter
 - ▶ 30 000 Unternehmen vertrauen uns

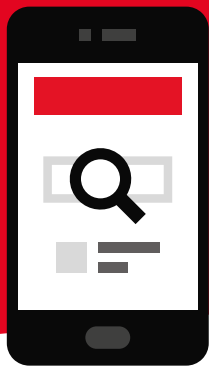
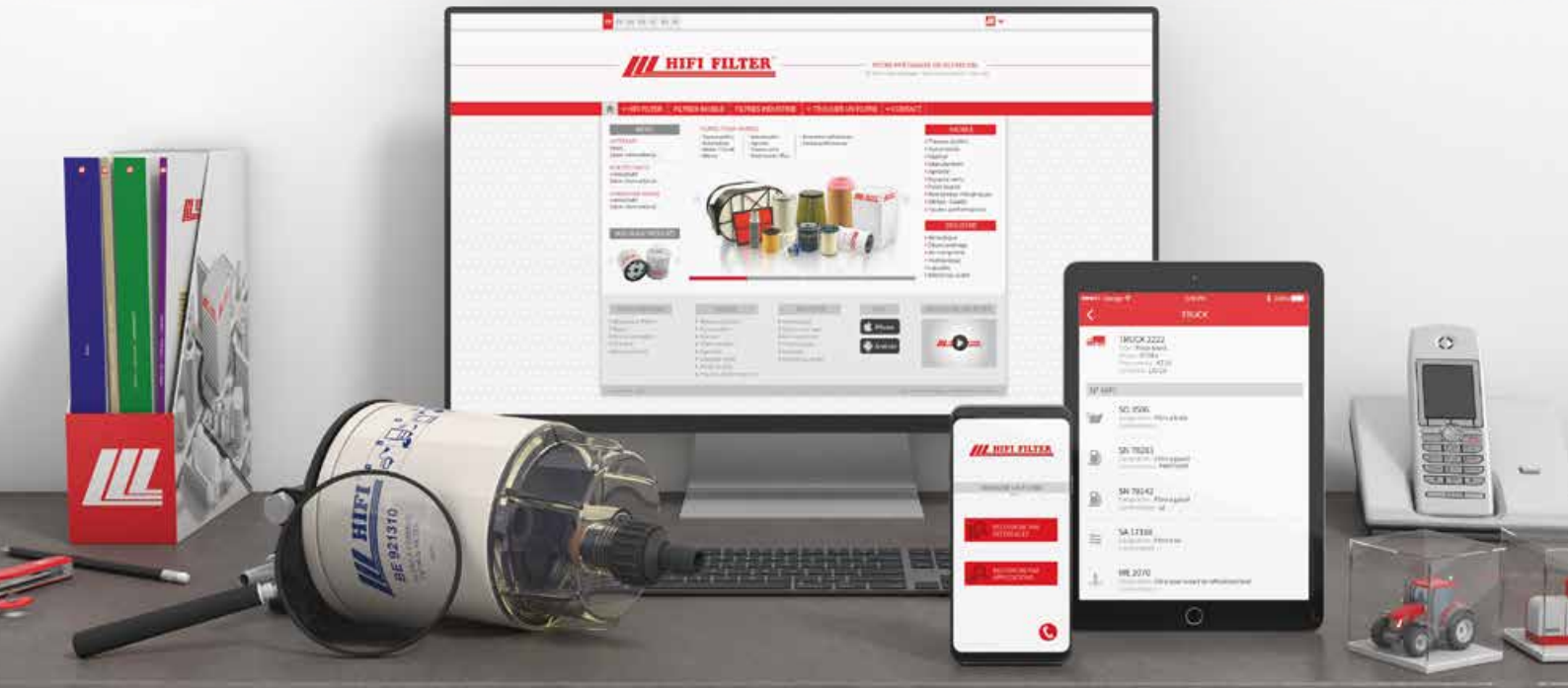

HIFI FILTER APPS

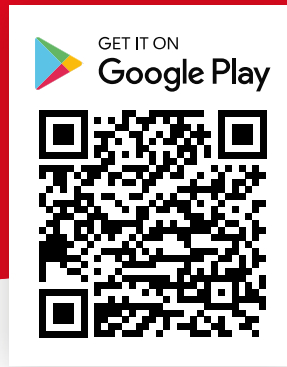

hifi-filter.com

À QUOI CORRESPOND UN MICRON ?

HOW BIG IS A MICRON ? - WIE GROSS IST EIN MIKRON ?

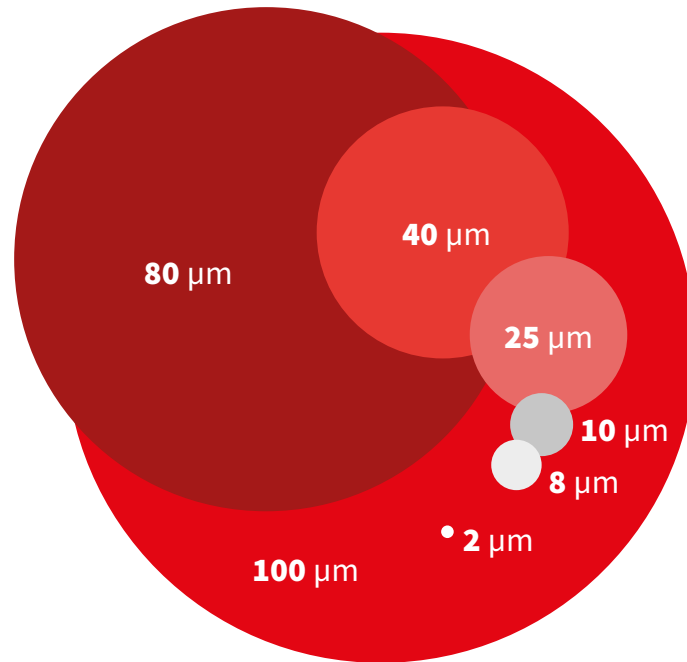

Échelle 1 x 1200



1000 μm = 1 mm

1 μm = 0.001 mm

	FR	EN	DE
100 μm	Grain sel de table	Grain of table salt	Speisesalz Korn
80 μm	Cheveu humain	Human hair	Menschenhaar
40 μm	Seuil limite de visibilité	Lower limit of visibility	Sichtbarkeitsschwelle
25 μm	Globules blancs	White blood cell	Weisse Blutzellen
10 μm	Talc	Talcum powder	Talkumpuder
8 μm	Globules rouges	Red blood cell	Rote Blutzellen
2 μm	Bactérie	Bacteria	Bakterien

TABLEAU DE CONVERSION

CONVERSION CHART / UMRECHNUNGSTABELLE

US MESH	µm
10	2000
12	1680
14	1410
16	1190
18	1000
20	841
25	707
30	595
35	500
40	420
45	354
50	297
60	250
70	210
80	177
100	149
120	125
140	105
170	88
200	74
230	63
270	53
325	44
400	37
550	25
625	20
1250	10
1750	8
2500	5
5000	2.5
12000	1

Rapport Bêta * Beta Report * Betarapport *	Efficacité Efficiency Leistung	Filtration
βx = 2	50,0 %	Nominale
βx = 10	90,0 %	Nominale
βx = 20	95,0 %	Nominale
βx = 75	98,7 %	Absolue
βx = 200	99,5 %	Absolue
βx = 1000	99,9 %	Absolue

* x = Taille des particules en µm

* x = Particles size in µm

* x = Grösse der Partikel in µm



APPLICATIONS APPLICATIONS ANWENDUNGEN



DAMEUSES SNOW-GROOMING MACHINES PISTENBULLY

DAMEUSES (APPLICATIONS)

SNOW-GROOMING MACHINES (APPLICATIONS)
PISTENBULLY (ANWENDUNGEN)

12

FILTRES POUR DAMEUSES

FILTERS FOR SNOW-GROOMING MACHINES
FILTER FÜR PISTENBULLY

22

AZTEC

CANONIT

Type mach. DAMEUSE
 Mot.make CATERPILLAR
 Mot.type C9
 Mot.energ. DIESEL
 hp/kw 330HP/246KW
 Oil/Oel : SO 10052

DOLOMIT

Type mach. DAMEUSE
 Année-> 2012
 Mot.make CATERPILLAR
 Mot.type C13
 Mot.energ. DIESEL
 hp/kw 490HP/365KW
 Serie n°-> DS12.000
 Oil/Oel : SO 10052
 Gasoil : SN 912010 PRIM
 Gasoil : SN 55429
 Air1/Luft: SA 16474
 Hydraulic: SH 74248 SP

DOLOMIT EVOLUTION

Type mach. DAMEUSE
 Année-> 2014
 Mot.make VOLVO PENTA
 Mot.type D 13
 Mot.energ. DIESEL

GRAPHIT

Type mach. DAMEUSE
 Année-> 2012
 Mot.make CATERPILLAR
 Mot.type C 13
 Mot.energ. DIESEL
 hp/kw 485HP/354KW
 Serie n°-> GW
 Oil/Oel : SO 10052
 Gasoil : SN 912010 PREF/VORF
 Gasoil : SN 55429
 Air1/Luft: SA 16474
 Hydraulic: SH 74248 SP
 Aera/Vent: TCO 732 HYD

BOMBARDIER

BR 120

Type mach. DAMEUSE
 Mot.make PERKINS
 Mot.type 1104C-E44T
 Mot.energ. DIESEL

BR 160

Type mach. DAMEUSE
 Mot.make PERKINS
 Mot.type 1006.6 T
 Mot.energ. DIESEL
 Hydraulic: SH 66542 X2

BR 180

Type mach. DAMEUSE
 Mot.make PERKINS
 Mot.type 1006.60 TW
 Mot.energ. DIESEL

BR 2000

Type mach. DAMEUSE
 Mot.make CUMMINS
 Mot.energ. DIESEL
 Oil/Oel : SO 10011
 Gasoil : SN 55002 PREF/VORF
 Gasoil : SN 40514
 Air1/Luft: SA 11763
 Eau/Cool.: WE 2074
 Hydraulic: SH 52131 +
 Hydraulic: SH 52933
 Hydraulic: SH 84018 TREUIL/WINDE

BOMBARDIER

BR 275

Type mach. DAMEUSE
 Mot.make CUMMINS
 Mot.type 6 CTA 8.3
 Mot.energ. DIESEL

BR 350

Type mach. DAMEUSE
 Mot.make CATERPILLAR
 Mot.type C 9
 Mot.energ. DIESEL

BR 400

Type mach. DAMEUSE
 Mot.make CUMMINS
 Mot.type 6 CTA 8.3
 Mot.energ. DIESEL
 Oil/Oel : SO 10011
 Gasoil : SN 55002 PREF/VORF
 Gasoil : SN 40514
 Air1/Luft: SA 11763
 Hydraulic: SH 63076
 Hydraulic: SH 56560 CARTE/INS VISSE/SCHR

JUMBO

Type mach. DAMEUSE
 Mot.make VOLVO
 Mot.type TD 100 G
 Mot.energ. DIESEL

Oil/Oel : SO 4017 ->1985
 Oil/Oel : SO 180 1986->
 Gasoil : SN 5074 X2
 Hydraulic: SH 74121 RETOUR/RUCK
 Hydraulic: SH 52933 ASP/SAUGFILT

MP PLUS

Type mach. DAMEUSE
 Mot.make CUMMINS
 Mot.energ. DIESEL
 Oil/Oel : SO 3000
 Gasoil : SN 5038 PRIM
 Gasoil : SN 5052 SECON ->97
 Gasoil : SN 55002 SECON 97->
 Air1/Luft: SA 11763
 Eau/Cool.: WE 2071
 Hydraulic: SH 66542 X3 +
 Hydraulic: SH 56560
 Pilot. : SH 63076

YETI-M

Type mach. DAMEUSE
 Mot.make CUMMINS
 Mot.energ. DIESEL
 Oil/Oel : SO 734
 Gasoil : SN 5038 PRIM
 Gasoil : SN 5052 SECON
 Eau/Cool.: WE 2071
 Hydraulic: SH 74121 RETOUR/RUCK
 Hydraulic: SH 52933 ASP/SAUGFILT

300 MP

Type mach. DAMEUSE
 Mot.make DETROIT
 Mot.energ. DIESEL
 Oil/Oel : SO 3640
 Gasoil : SN 55002 PREF/VORF
 Gasoil : SN 5019 PRIM
 Gasoil : SN 5269 SECON
 Air1/Luft: SA 11763
 Eau/Cool.: WE 2104
 Hydraulic: SH 84018 TREUIL/WINDE
 Hydraulic: SH 52933
 Hydraulic: SH 52131

CM DUPON

ALPINE 510

Type mach. DAMEUSE
 Année-> 2017
 Mot.make VOLVO PENTA
 Mot.type D 13 TIER 4F
 Mot.energ. DIESEL
 Gasoil : SN 926030 PRIM
 Gasoil : SN 70201
 Hydraulic: SH 74248 SP

FAVERO LORENZO

NEW SNOW RABBIT 3X

Type mach. DAMEUSE
 Mot.make KOHLER
 Mot.type KD13404T-SCR
 Mot.energ. DIESEL
 hp/kw 134HP/100KW
 Oil/Oel : SO 11159
 Gasoil : SN 25098 PRIM

NEW SNOW RABBIT 3X

Type mach. DAMEUSE
 Mot.make VM
 Mot.type R 754 IE4
 Mot.energ. DIESEL
 Oil/Oel : SO 8550
 Gasoil : SN 80028 PRIM

NEW SNOW RABBIT 3X

Type mach. DAMEUSE
 Mot.make KUBOTA
 Mot.type V3800-CR-TE4
 Mot.energ. DIESEL
 Oil/Oel : SO 6205
 Gasoil : SN 25090 PREF/VORF
 Gasoil : SN 25135 PRIM
 Gasoil : SN 25025 SECON

SNOW PORTER 2

Type mach. DAMEUSE

SNOW RABBIT 3

Type mach. DAMEUSE
 Mot.make VM
 Mot.energ. DIESEL

FORMATIC

VOIR AUSSI/SEE/SIEHE KASSBOHRER

Type mach. .

FROSTY 652 DX

Type mach. TRANSPORTEUR
 Mot.make VM
 Mot.type HR 394 H
 Mot.energ. DIESEL
 Oil/Oel : SO 8590
 Gasoil : SN 001
 Air1/Luft: SA 17440
 Hydraulic: SH 63061 +
 Hydraulic: SH 63161

FORMATIC

G 350

Type mach.	DAMEUSE	
Mot.make	CUMMINS	
Mot.type	QSL 9	
Mot.energ.	DIESEL	
hp/kw	350HP/261KW	
Oil/Oel :	SO 10011	
Gasoil :	SN 40602	PRIM
Gasoil :	SA 40606	
Air1/Luft:	SA 16125	
Air2/Luft:	SA 16127	
Eau/Cool.:	WE 2076	
Hydraulic:	SH 74159 SP	+
Hydraulic:	SH 55500	

GT 450

Type mach.	DAMEUSE	
Année->	2005	
Mot.make	CUMMINS	
Mot.type	QSM 11	
Mot.energ.	DIESEL	
Oil/Oel :	SO 10020	
Gasoil :	SN 40512	
Air1/Luft:	SA 16120	
Air2/Luft:	SA 16121	
Eau/Cool.:	WE 2075	
Hydraulic:	SH 74156 SP	CART/EINS +
Hydraulic:	SH 55500	VISSE/SCHR

P 6-130

Type mach.	DAMEUSE	
Mot.make	CUMMINS	
Mot.type	6 CTA 5.9	
Mot.energ.	DIESEL	

P 6-200

Type mach.	DAMEUSE	
Mot.make	CUMMINS	
Mot.type	6 CTA 5.9	
Mot.energ.	DIESEL	

SUPER G 11

Type mach.	DAMEUSE	
Mot.make	CUMMINS	
Mot.type	M 11	
Mot.energ.	DIESEL	
Oil/Oel :	SO 3000	
Gasoil :	SN 40512	

SUPER G 8

Type mach.	DAMEUSE	
Mot.make	CUMMINS	
Mot.type	6 CTA	
Mot.energ.	DIESEL	
Oil/Oel :	SO 10011	
Gasoil :	SN 1212	

X TRAIL 170

Type mach.	DAMEUSE	
Mot.make	SISU	
Mot.energ.	DIESEL	

X TRAIL 200

Type mach.	DAMEUSE	
Mot.make	CUMMINS	
Mot.type	QSB 5.9	
Mot.energ.	DIESEL	

FORMATIC

350

Type mach.	DAMEUSE	
Année->	2011	
Mot.make	CUMMINS	
Mot.type	QSL 9	
Mot.energ.	DIESEL	
hp/kw	350HP/261KW	
Oil/Oel :	SO 10011	
Gasoil :	SN 40602	PRIM
Gasoil :	SA 40606	SECON
Air1/Luft:	SA 16125	
Eau/Cool.:	WE 2076	
Hydraulic:	SH 74159 SP	+
Hydraulic:	SH 55500	

HAGGLUNDS

BV 206

Type mach.	TRANSPORTEUR	
Mot.make	MERCEDES	
Mot.type	OM 612.981	
Mot.energ.	DIESEL	
Oil/Oel :	SO 7099	

TL 4

Type mach.	TRANSPORTEUR	
Mot.make	CUMMINS	
Mot.type	6 BTA 5.9	
Mot.energ.	DIESEL	
Oil/Oel :	SO 10008	
Gasoil :	SN 5038	PRIM
Gasoil :	SN 5052	SECON

KASSBOHRER

VOIR AUSSI/SEE/SIEHE FORMATIC

Type mach. .

VOIR AUSSI/SEE/SIEHE PAANA

Type mach. .

CANYON

Type mach.	TRANSPORTEUR	
Mot.make	VW	
Mot.type	1.9TDI	
Mot.energ.	DIESEL	
Oil/Oel :	SO 7063	
Gasoil :	SN 70146	
Air1/Luft:	SA 17100	
Hydraulic:	SH 74169 SP	

PAANA 125

Type mach.	DAMEUSE	
Année->	2009	
Mot.make	CUMMINS	
Mot.type	QSB 4.5	
Mot.energ.	DIESEL	
hp/kw	115HP/85KW	
Oil/Oel :	SO 10046	
Gasoil :	SN 40602	PRIM
Gasoil :	SN 40529	SECON
Air1/Luft:	SA 16229	
Air2/Luft:	SA 16265	OPTION
Hydraulic:	SH 56775	VISSE/SCHR +
Hydraulic:	SH 74159 SP	CART/EINS

KASSBOHRER

PB 100

Type mach.	DAMEUSE	
Année->	1998	
Mot.make	MERCEDES	
Mot.type	OM 904 LA	
Mot.energ.	DIESEL	
Oil/Oel :	SO 7081	
Gasoil :	SN 70160	PREF/VORF
Gasoil :	SN 70154	
Air1/Luft:	SA 13990	OU/ODER
Air1/Luft:	SA 17321	RADIALSEAL
Hydraulic:	SH 52309	ANCIEN MONT.
Hydraulic:	SH 52278	NOUVEAU MONT.
Hydraulic:	SH 77256	ASP/SAUGFILT
Aera/Vent:	FS 268	HYD

PB 100 D

Type mach.	DAMEUSE	
Mot.make	MERCEDES	
Mot.energ.	DIESEL	
Oil/Oel :	SO 646	
Gasoil :	SN 268	
Air1/Luft:	SA 606	H:107MM OU/ODER
Air1/Luft:	SA 14017	H:293MM
Hydraulic:	SH 52301	H:230MM OU/ODER
Hydraulic:	SH 52019	H:330MM

PB 100 SCR

Type mach.	DAMEUSE	
Année->	2016	
Mot.make	MERCEDES	
Mot.type	OM924LA TIER 4	
Mot.energ.	DIESEL	
hp/kw	204HP/152KW	
Serie n°->	82111547	
Oil/Oel :	SO 7081	
Ad blue :	SD 70322	
Gasoil :	SN 70160	PREF/VORF
Gasoil :	SN 909110	PRIM
Gasoil :	SN 70154	SECON
Air1/Luft:	SA 17321	
Hydraulic:	SH 52278	RETOUR/RUCK
Hydraulic:	SH 77256	ASP/SAUGFILT
Dessic/Dr:	TB 1390	
Aera/Vent:	FS 268	HYD

PB 100 SCR GREEN IQ

Type mach.	DAMEUSE	
Année->	2016	
Mot.make	MERCEDES	
Mot.type	OM924LA TIER 4	
Mot.energ.	DIESEL	
hp/kw	204HP/152KW	
Serie n°->	82111547	
Oil/Oel :	SO 7081	
Ad blue :	SD 70322	
Gasoil :	SN 70160	PREF/VORF
Gasoil :	SN 909110	PRIM
Gasoil :	SN 70154	SECON
Air1/Luft:	SA 17321	
Hydraulic:	SH 52278	RETOUR/RUCK
Hydraulic:	SH 77256	ASP/SAUGFILT
Dessic/Dr:	TB 1390	
Aera/Vent:	FS 268	HYD

KASSBOHRER

PB 100 4F

Type mach. DAMEUSE
 Année-> 2016
 Mot.make CUMMINS
 Mot.type QSB 6.7 TIER 4
 Mot.energ. DIESEL
 hp/kw 253HP/188KW
 Oil/Oel : SO 10046
 Ad blue : SD 70380
 Gasoil : SN 40706 PRIM
 Gasoil : SN 40705 SECON
 Air1/Luft : SA 17321
 Hydraulic: SH 74169 SP RETOUR/RUCK
 Hydraulic: KJ 74003 GASKET KIT
 Hydraulic: SH 77256 ASP/SAUGFILT
 Aera/Vent: FS 268 HYD
 Aera/Vent: SAO 16799 MOT/ENG

PB 110 D

Type mach. DAMEUSE
 Mot.make MERCEDES
 Mot.energ. DIESEL
 Oil/Oel : SO 646
 Gasoil : SN 268
 Air1/Luft: SA 606 H:107MM OU/ODER
 Air1/Luft: SA 14017 H:293MM
 Hydraulic: SH 52301 H:230MM OU/ODER
 Hydraulic: SH 52019 H:330MM

PB 120 D

Type mach. DAMEUSE
 Mot.make MERCEDES
 Mot.energ. DIESEL
 Oil/Oel : SO 646
 Gasoil : SN 268
 Air1/Luft: SA 606 H:107MM OU/ODER
 Air1/Luft: SA 14017 H:293MM
 Hydraulic: SH 52301 H:229MM OU/ODER
 Hydraulic: SH 52300 H:298MM

PB 130 D

Type mach. DAMEUSE
 Mot.make MERCEDES
 Mot.energ. DIESEL
 Oil/Oel : SO 646
 Gasoil : SN 268
 Air1/Luft: SA 606 H:107MM OU/ODER
 Air1/Luft: SA 14017 H:293MM
 Hydraulic: SH 52933 H:330MM O:89MM OU/OD
 Hydraulic: SH 52300 H:298MM OU/ODER
 Hydraulic: SH 52019 H:330MM O:110MM

PB 145 D

Type mach. DAMEUSE
 Mot.make MERCEDES
 Mot.energ. DIESEL
 Oil/Oel : SO 4105
 Gasoil : SN 1146 PRIM
 Gasoil : SN 090 SECON
 Air1/Luft: SA 606 H:107MM OU/ODER
 Air1/Luft: SA 14017 H:293MM
 Hydraulic: SH 52301

PB 150 D

Type mach. DAMEUSE
 Mot.make VM
 Mot.type HR 694 HT
 Mot.energ. DIESEL
 Oil/Oel : SO 242
 Gasoil : SN 327
 Air1/Luft: SA 13990
 Hydraulic: SH 52300

KASSBOHRER

PB 160 D

Type mach. DAMEUSE
 Mot.make VM
 Mot.type HR 964 HT
 Mot.energ. DIESEL
 Oil/Oel : SO 242
 Gasoil : SN 327
 Air1/Luft: SA 13990
 Hydraulic: SH 52300
 Hydraulic: SH 77256 ASP/SAUGFILT

PB 170 D

Type mach. DAMEUSE
 Mot.make MERCEDES
 Mot.energ. DIESEL
 Oil/Oel : SO 4105
 Gasoil : SN 1146
 Air1/Luft: SA 11552
 Hydraulic: SH 52301 X3

PB 200 D

Type mach. DAMEUSE
 Année-> 2005
 Mot.make MERCEDES
 Mot.type OM 926 LA
 Mot.energ. DIESEL
 Oil/Oel : SO 7082
 Gasoil : SN 70154
 Air1/Luft: SA 10920 ->82511718
 Air1/Luft: SA 17281 82511719->
 Hydraulic: SH 52309 ->82511121
 Hydraulic: SH 74186 SP 82511122->
 Hydraulic: SH 62305 FREIN/BREMSE

PB 200 D

Type mach. DAMEUSE
 Mot.make MERCEDES
 Mot.type OM 366
 Mot.energ. DIESEL
 Oil/Oel : SO 3320 O:120MM OU/ODER
 Oil/Oel : SO 7001 O:82MM
 Gasoil : SN 090 X2
 Air1/Luft: SA 11552 H:387MM OU/ODER
 Air1/Luft: SA 14017 H:293MM
 Hydraulic: SH 52301 X3 H:229MM OU/ODER
 Hydraulic: SH 52300 X3 H:298MM

PB 200 D

Type mach. DAMEUSE
 Mot.make MERCEDES
 Mot.type OM 362 LA
 Mot.energ. DIESEL
 hp/kw 191HP/142KW
 Oil/Oel : SO 3320
 Gasoil : SN 090 X2
 Air1/Luft: SA 11552
 Hydraulic: SH 52301 X3 H:229MM OU/ODER
 Hydraulic: SH 52300 X3 H:298MM

PB 210 D

Type mach. DAMEUSE
 Mot.make MERCEDES
 Mot.type OM 366
 Mot.energ. DIESEL
 Oil/Oel : SO 3320 O:120MM OU/ODER
 Oil/Oel : SO 7001 O:82MM
 Gasoil : SN 090 X2
 Air1/Luft: SA 11552 H:387MM OU/ODER
 Air1/Luft: SA 14017 H:293MM
 Hydraulic: SH 52301 X3 H:229MM OU/ODER
 Hydraulic: SH 52300 X3 H:298MM

KASSBOHRER

PB 22.130 D

Type mach. DAMEUSE
 Mot.make MERCEDES
 Mot.type OM 617 A
 Mot.energ. DIESEL
 Oil/Oel : SO 3320 O:120MM OU/ODER
 Oil/Oel : SO 7001 O:82MM
 Gasoil : SN 090 X2
 Air1/Luft: SA 11552 H:387MM OU/ODER
 Air1/Luft: SA 14017 H:293MM
 Hydraulic: SH 52301 X3

PB 220 DR

Type mach. DAMEUSE
 Mot.make MERCEDES
 Mot.type OM 366 A
 Mot.energ. DIESEL
 Oil/Oel : SO 3320 O:120MM OU/ODER
 Oil/Oel : SO 7001 O:82MM
 Gasoil : SN 090 X2
 Air1/Luft: SA 11552 H:387MM OU/ODER
 Air1/Luft: SA 14017 H:293MM
 Hydraulic: SH 52301 X3

PB 230 DR

Type mach. DAMEUSE
 Mot.make CUMMINS
 Mot.energ. DIESEL
 Oil/Oel : SO 3345 4 CYL OU/ODER
 Oil/Oel : SO 3349 6 CYL
 Gasoil : SN 1276 H:187MM OU/ODER
 Gasoil : SN 1251 H:142MM
 Air1/Luft: SA 14019
 Hydraulic: SH 52309 ANCIEN MONT.
 Hydraulic: SH 52278 NOUVEAU MONT.

PB 240 D

Type mach. DAMEUSE
 Mot.make CUMMINS
 Mot.energ. DIESEL
 Oil/Oel : SO 734 H:200MM OU/ODER
 Oil/Oel : SO 3000 H:300MM
 Gasoil : SN 1276 H:180MM OU/ODER
 Gasoil : SN 1251 H:145MM
 Air1/Luft: SA 10920
 Eau/Cool.: WE 2071 OU/ODER
 Eau/Cool.: WE 2073
 Hydraulic: SH 52309 ANCIEN MONT.
 Hydraulic: SH 52278 NOUVEAU MONT.
 Hydraulic: SH 52209 +
 Hydraulic: SH 64179 TREUIL/WINDE

PB 25.130 D

Type mach. DAMEUSE
 Mot.make MERCEDES
 Mot.type OM 617 A
 Mot.energ. DIESEL
 Oil/Oel : SO 3320 O:120MM OU/ODER
 Oil/Oel : SO 7001 O:82MM
 Gasoil : SN 090 X2
 Air1/Luft: SA 11552 H:387MM OU/ODER
 Air1/Luft: SA 14017 H:293MM
 Hydraulic: SH 52301 X3

KASSBOHRER

PB 260 DW

Type mach.	DAMEUSE	
Mot.make	CUMMINS	
Mot.energ.	DIESEL	
Oil/Oel :	SO 734	H:200MM OU/ODER
Oil/Oel :	SO 3000	H:300MM
Gasoil :	SN 1276	H:180MM OU/ODER
Gasoil :	SN 1251	H:145MM
Air1/Luft:	SA 10920	
Eau/Cool.:	WE 2071	OU/ODER
Eau/Cool.:	WE 2073	
Hydraulic:	SH 52309	ANCIEN MONT.
Hydraulic:	SH 52278	NOUVEAU MONT.
Hydraulic:	SH 52209	+
Hydraulic:	SH 64179	TREUIL/WINDE

PB 270 DS

Type mach.	DAMEUSE	
Mot.make	MERCEDES	
Mot.type	OM 421 A	
Mot.energ.	DIESEL	
Oil/Oel :	SO 3327	H:228MM OU/ODER
Oil/Oel :	SO 3320	H:171MM
Gasoil :	SN 066	X2
Air1/Luft:	SA 13990	H:375MM OU/ODER
Air1/Luft:	SA 10920	H:500MM
Hydraulic:	SH 52933	X3
Hydraulic:	SH 77250	ASP/SAUGFILT +
Hydraulic:	SH 77256	ASP/SAUGFILT

PB 280 D

Type mach.	DAMEUSE	
Mot.make	CUMMINS	
Mot.type	6 CTA 8.3	
Mot.energ.	DIESEL	
Oil/Oel :	SO 3000	
Gasoil :	SN 1276	H:180MM OU/ODER
Gasoil :	SN 1251	H:145MM
Air1/Luft:	SA 10920	
Eau/Cool.:	WE 2071	OU/ODER
Eau/Cool.:	WE 2073	
Hydraulic:	SH 52309	ANCIEN MONT.
Hydraulic:	SH 52278	NOUVEAU MONT.
Hydraulic:	SH 52209	+
Hydraulic:	SH 64179	TREUIL/WINDE

PB 300

Type mach.	DAMEUSE	
Mot.make	MERCEDES	
Mot.type	OM 926 LA	
Mot.energ.	DIESEL	
Oil/Oel :	SO 7082	
Gasoil :	MO 3006	PREF/VORF
Gasoil :	SN 70154	
Air1/Luft:	SA 10920	OU/ODER
Air1/Luft:	SA 17281	RADIALSEAL
Hydraulic:	SH 52309	ANCIEN MONT.
Hydraulic:	SH 52278	NOUVEAU MONT.
Hydraulic:	SH 74186 SP	RETOUR/RUCK
Hydraulic:	SH 77256	ASP/SAUGFILT

PB 300 D/W

Type mach.	DAMEUSE	
Année->	2000	
Mot.make	MERCEDES	
Mot.type	OM 926 LA	
Mot.energ.	DIESEL	
Oil/Oel :	SO 7082	
Gasoil :	SN 70154	
Air1/Luft:	SA 10920	->11791
Air2/Luft:	SA 17281	11792->
Hydraulic:	SH 52309	ANCIEN MONT.
Hydraulic:	SH 52278	NOUVEAU MONT.
Hydraulic:	SH 64179	TREUIL/WINDE
Hydraulic:	SH 77255	ASP/SAUGFILT +
Hydraulic:	SH 77256	ASP/SAUGFILT

KASSBOHRER

PB 300 POLAR

Type mach.	DAMEUSE	
Année->	2002	
Mot.make	MERCEDES	
Mot.type	OM 457 LA	
Mot.energ.	DIESEL	
hp/kw	430HP/320KW	
Oil/Oel :	SO 7139	
Gasoil :	SN 70160	PREF/VORF
Gasoil :	SN 70141	
Air1/Luft:	SA 17281	->11791
Air1/Luft:	SA 11752	11792->
Hydraulic:	SH 74186 SP	
Hydraulic:	SH 64179	TREUIL/WINDE
Hydraulic:	SH 62305	FREIN/BREMSE

PB 300 W

Type mach.	DAMEUSE	
->Année	2000	
Mot.make	DETROIT	
Mot.type	SERIE 40	
Mot.energ.	DIESEL	
Oil/Oel :	SO 3640	HORIZ/LIEGEND OU/ODE
Oil/Oel :	SO 10056	VERTIC/TOP
Gasoil :	SN 5019	PREF/VORF
Gasoil :	SN 5269	
Air1/Luft:	SA 10920	
Eau/Cool.:	WE 2106	OU/ODER
Eau/Cool.:	WE 2104	
Hydraulic:	SH 52309	X2 ANCIEN MONT.
Hydraulic:	SH 52278	X2 NOUVEAU MONT.
Hydraulic:	SH 64179	TREUIL/WINDE
Hydraulic:	SH 77255	ASP/SAUGFILT +
Hydraulic:	SH 77256	ASP/SAUGFILT

PB 320 D / PB 330 D

Type mach.	DAMEUSE	
Mot.make	MERCEDES	
Mot.type	OM 441 LA	
Mot.energ.	DIESEL	
Oil/Oel :	SO 7034	
Gasoil :	SN 066	X2
Air1/Luft:	SA 14010	
Hydraulic:	SH 52309	ANCIEN MONT.
Hydraulic:	SH 52278	NOUVEAU MONT.

PB 36.170 DR

Type mach.	DAMEUSE	
Mot.make	MERCEDES	
Mot.type	OM 352 LA	
Mot.energ.	DIESEL	
Oil/Oel :	SO 3327	H:228MM OU/ODER
Oil/Oel :	SO 3320	H:171MM OU/ODER
Oil/Oel :	SO 4105	H:195MM
Gasoil :	SN 090	X2
Air1/Luft:	SA 13990	H:375MM OU/ODER
Air1/Luft:	SA 10920	H:500MM
Hydraulic:	SH 52301	

PB 36.200 D

Type mach.	DAMEUSE	
Mot.make	MERCEDES	
Mot.type	OM 352 LP	
Mot.energ.	DIESEL	
Oil/Oel :	SO 3327	H:228MM OU/ODER
Oil/Oel :	SO 3320	H:171MM OU/ODER
Oil/Oel :	SO 4105	H:195MM
Gasoil :	SN 090	X2
Air1/Luft:	SA 13990	H:375MM OU/ODER
Air1/Luft:	SA 10920	H:500MM
Hydraulic:	SH 52301	H:229MM OU/ODER
Hydraulic:	SH 52933	H:330MM

KASSBOHRER

PB 36.240 D

Type mach.	DAMEUSE	
Mot.make	CUMMINS	
Mot.energ.	DIESEL	
Oil/Oel :	SO 734	
Gasoil :	SN 5038	PRIM
Gasoil :	SN 5052	SECON
Air1/Luft:	SA 13990	H:375MM OU/ODER
Air1/Luft:	SA 10920	H:500MM
Hydraulic:	SH 52933	

PB 39.170 DR

Type mach.	DAMEUSE	
Mot.make	MERCEDES	
Mot.type	OM 352 LA	
Mot.energ.	DIESEL	
Oil/Oel :	SO 3327	H:228MM OU/ODER
Oil/Oel :	SO 3320	H:171MM OU/ODER
Oil/Oel :	SO 4105	H:195MM
Gasoil :	SN 090	X2
Air1/Luft:	SA 13990	H:375MM OU/ODER
Air1/Luft:	SA 10920	H:500MM
Hydraulic:	SH 52301	

PB 39.200 D

Type mach.	DAMEUSE	
Mot.make	MERCEDES	
Mot.type	OM 352 LP	
Mot.energ.	DIESEL	
Oil/Oel :	SO 3327	H:228MM OU/ODER
Oil/Oel :	SO 3320	H:171MM OU/ODER
Oil/Oel :	SO 4105	H:195MM
Gasoil :	SN 090	X2
Air1/Luft:	SA 13990	H:375MM OU/ODER
Air1/Luft:	SA 10920	H:500MM
Hydraulic:	SH 52301	H:229MM OU/ODER
Hydraulic:	SH 52933	H:330MM

PB 39.240 D

Type mach.	DAMEUSE	
Mot.make	CUMMINS	
Mot.energ.	DIESEL	
Oil/Oel :	SO 734	
Gasoil :	SN 5038	PRIM
Gasoil :	SN 5052	SECON
Air1/Luft:	SA 13990	H:375MM OU/ODER
Air1/Luft:	SA 10920	H:500MM
Hydraulic:	SH 52933	

PB 400 PARK PRO

Type mach.	DAMEUSE	
Année->	2015	
Mot.make	CUMMINS	
Mot.type	QSL 9 TIER III	
Mot.energ.	DIESEL	
hp/kw	370HP/276KW	
Oil/Oel :	SO 10011	
Gasoil :	SN 40602	PRIM
Gasoil :	SN 40606	SECON
Air1/Luft:	SA 17281	
Eau/Cool.:	WE 2076	
Hydraulic:	SH 74186 SP	
Hydraulic:	SH 62305	FREIN+CHENILLES

DAMEUSES | SNOW-GROOMING MACHINES | PISTENBULLY

KASSBOHRER

PB 400 W

Type mach. DAMEUSE
 Année-> 2008
 Mot.make CUMMINS
 Mot.type QSL 9
 Mot.energ. DIESEL
 hp/kw 370HP/276KW
 Oil/Oel : SO 10011
 Gasoil : SN 40602 PRIM
 Gasoil : SN 40606 SECON
 Air1/Luft: SA 17281
 Eau/Cool.: WE 2076
 Hydraulic: SH 74186 SP RETOUR/RUCK
 Hydraulic: SH 64179 TREUIL/WINDE
 Hydraulic: SH 77256 ASP/SAUGFILT +
 Hydraulic: SH 77254 ASP/SAUGFILT
 Hydraulic: SH 62305 FREIN/BREMSE
 Aera/Vent: FS 268 HYD

PB 43.270 D

Type mach. DAMEUSE
 Mot.make MERCEDES
 Mot.type OM 421 A
 Mot.energ. DIESEL
 Oil/Oel : SO 3327 H:228MM OU/ODER
 Oil/Oel : SO 3320 H:171MM
 Gasoil : SN 066 X2
 Air1/Luft: SA 13990 H:375MM OU/ODER
 Air1/Luft: SA 10920 H:500MM
 Hydraulic: SH 52933 X3

PB 60

Type mach. DAMEUSE
 Mot.make MERCEDES
 Mot.energ. DIESEL
 Oil/Oel : SO 646
 Gasoil : SN 268
 Air1/Luft: SA 606 H:107MM OU/ODER
 Air1/Luft: SA 14017 H:293MM
 Hydraulic: SH 52301 H:230MM OU/ODER
 Hydraulic: SH 52019 H:330MM

PB 600 E+

Type mach. DAMEUSE
 Année-> 2016
 Mot.make MERCEDES
 Mot.type OM460LA/TIER3A
 Mot.energ. DIESEL
 hp/kw 400HP/298KW

PB 600 LEVEL RED

Type mach. DAMEUSE
 Année-> 2018
 Mot.make CUMMINS
 Mot.type X12
 Mot.energ. DIESEL
 Oil/Oel : SO 10179
 Ad blue : KD 70436 +
 Ad blue : SD 70382
 Gasoil : SN 40650 PRIM
 Gasoil : SN 40736 SECON ->10284
 Gasoil : SN 35012 SECON 10285->
 Air1/Luft: SA 17278
 Hydraulic: SH 74186 SP
 Hydraulic: SH 52247 PRESSION/DRUCK
 Hydraulic: SH 64179 TREUIL/WINDE
 Hydraulic: SH 77256 ASP/SAUGFILT +
 Hydraulic: SH 77254 ASP/SAUGFILT
 Aera/Vent: SA 12519 X2 HYD

KASSBOHRER

PB 600 POLAR

Type mach. DAMEUSE
 Année-> 2006
 Mot.make MERCEDES
 Mot.type OM 460 LA
 Mot.energ. DIESEL
 hp/kw 490HP/365KW
 Oil/Oel : SO 7139
 Gasoil : SN 70160 PREF/VORF
 Gasoil : SN 70141
 Air/Luft : SA 17278
 Hydraulic: SH 74186 SP
 Hydraulic: SH 64179 TREUIL/WINDE
 Hydraulic: SH 77256 ASP/SAUGFILT +
 Hydraulic: SH 77254 ASP/SAUGFILT
 Hydraulic: SH 62305 FREIN/BREMSE
 Pilot : SH 62305 TENSION CHENILLES
 Aera/Vent: FS 268 HYD
 Aera/Vent: SAO 5369 X2 MOT/ENG

PB 600 POLAR

Type mach. DAMEUSE
 Année-> 2012
 Mot.make MERCEDES
 Mot.type OM 460LA TIER4I
 Mot.energ. DIESEL
 hp/kw 530HP/395KW
 Oil/Oel : SO 7139
 Ad blue : KD 70322
 Gasoil : SN 909110 PRIM
 Gasoil : SN 70141
 Air/Luft : SA 17278
 Hydraulic: SH 74186 SP RETOUR/RUCK
 Hydraulic: SH 64179 TREUIL/WINDE
 Hydraulic: SH 77256 ASP/SAUGFILT +
 Hydraulic: SH 77254 ASP/SAUGFILT
 Hydraulic: SH 62305 FREIN/BREMSE
 Pilot : SH 62305 TENSION CHENILLES
 Dessic/Dr: TB 1390
 Aera/Vent: FS 268 HYD
 Aera/Vent: SAO 5369 X2 MOT/ENG

PB 600 POLAR SCR BLUE IQ

Type mach. DAMEUSE
 Année-> 2014
 Mot.make MERCEDES
 Mot.type OM 460LA TIER4I
 Mot.energ. DIESEL
 hp/kw 530HP/395KW
 Oil/Oel : SO 7139
 Ad blue : KD 70322
 Gasoil : SN 909110 PRIM
 Gasoil : SN 70141
 Air/Luft : SA 17278
 Hydraulic: SH 74186 SP
 Hydraulic: SH 64179 TREUIL/WINDE
 Hydraulic: SH 77256 ASP/SAUGFILT +
 Hydraulic: SH 77254 ASP/SAUGFILT
 Hydraulic: SH 62305 FREIN/BREMSE
 Pilot : SH 62305 TENSION CHENILLES
 Dessic/Dr: TB 1390
 Aera/Vent: FS 268 HYD
 Aera/Vent: SAO 5369 X2 MOT/ENG

KASSBOHRER

PB 600 SCR BLUE IQ

Type mach. DAMEUSE
 Année-> 2014
 Mot.make MERCEDES
 Mot.type OM 460LA TIER4I
 Mot.energ. DIESEL
 hp/kw 455HP/339KW
 Oil/Oel : SO 7139
 Ad blue : KD 70322
 Gasoil : SN 909110 PRIM
 Gasoil : SN 70141
 Air/Luft : SA 17278
 Hydraulic: SH 74186 SP
 Hydraulic: SH 64179 TREUIL/WINDE
 Hydraulic: SH 77256 ASP/SAUGFILT +
 Hydraulic: SH 77254 ASP/SAUGFILT
 Hydraulic: SH 62305 FREIN/BREMSE
 Pilot : SH 62305 TENSION CHENILLES
 Dessic/Dr: TB 1390
 Aera/Vent: FS 268 HYD
 Aera/Vent: SAO 5369 X2 MOT/ENG

PB 600 WP POLAR

Type mach. DAMEUSE
 Année-> 2018
 Mot.make CUMMINS
 Mot.type X12
 Mot.energ. DIESEL
 Oil/Oel : SO 10179
 Ad blue : SD 70382 +
 Ad blue : SD 70380
 Gasoil : SN 40650 PRIM
 Gasoil : SN 40736 SECON ->10284
 Gasoil : SN 35012 SECON 10285->
 Air1/Luft: SA 17278
 Hydraulic: SH 74186 SP
 Hydraulic: SH 52247 PRESSION/DRUCK
 Hydraulic: SH 64179 TREUIL/WINDE
 Hydraulic: SH 77256 ASP/SAUGFILT +
 Hydraulic: SH 77255 ASP/SAUGFILT
 Aera/Vent: SA 12519 X2 HYD

PB 600/W

Type mach. DAMEUSE
 Année-> 2006
 Mot.make MERCEDES
 Mot.type OM 460 LA
 Mot.energ. DIESEL
 hp/kw 400HP/298KW
 Oil/Oel : SO 7139
 Gasoil : SN 70160 PREF/VORF
 Gasoil : SN 70141
 Air/Luft : SA 17278
 Hydraulic: SH 74186 SP
 Hydraulic: SH 64179 TREUIL/WINDE
 Hydraulic: SH 77256 ASP/SAUGFILT +
 Hydraulic: SH 77254 ASP/SAUGFILT
 Hydraulic: SH 62305 FREIN/BREMSE
 Pilot : SH 62305 TENSION CHENILLES
 Aera/Vent: FS 268 HYD
 Aera/Vent: SAO 5369 X2 MOT/ENG

KASSBOHRER

PB 600/W

Type mach.	DAMEUSE
Année->	2012
Mot.make	MERCEDES
Mot.type	OM 460LA TIER4I
Mot.energ.	DIESEL
hp/kw	455HP/339KW
Oil/Oel :	SO 7139
Ad blue :	KD 70322
Gasoil :	SN 909110 PRIM
Gasoil :	SN 70141
Air/Luft :	SA 17278
Hydraulic:	SH 74186 SP RETOUR/RUCK
Hydraulic:	SH 64179 TREUIL/WINDE
Hydraulic:	SH 77256 ASP/SAUGFILT +
Hydraulic:	SH 77254 ASP/SAUGFILT
Hydraulic:	SH 62305 FREIN/BREMSE
Pilot. :	SH 62305 TENSION CHENILLES
Dessic/Dr:	TB 1390
Aera/Vent:	FS 268 HYD
Aera/Vent:	SAO 5369 X2 MOT/ENG

SCOUT

Type mach.	TRANSPORTEUR
Année->	2009
Mot.make	JOHN DEERE
Mot.type	5030 H
Mot.energ.	DIESEL
Oil/Oel :	SO 10067
Gasoil :	SN 70238

YUKON

Type mach.	TRANSPORTEUR
Année->	2002
Mot.make	VW
Mot.energ.	DIESEL
hp/kw	86HP/64KW

LEITNER

VOIR AUSSI/SEE/SIEHE PRINOTH

Type mach.	.
------------	---

LH 250 (TYPE BAS)

Type mach.	DAMEUSE
Oil/Oel :	SO 008

LH 250 (TYPE HAUT)

Type mach.	DAMEUSE
Oil/Oel :	SO 053
Gasoil :	SN 70103
Hydraulic:	SH 74004

LH 360

Type mach.	DAMEUSE
Mot.make	IVECO
Mot.energ.	DIESEL
hp/kw	120HP/89KW
Oil/Oel :	SO 287
Gasoil :	SN 037 PRIM
Gasoil :	SN 017 SECON
Air1/Luft:	SA 14531
Hydraulic:	SH 74004

LH 360

Type mach.	DAMEUSE
Mot.make	IVECO
Mot.energ.	DIESEL
hp/kw	150HP/111KW
Oil/Oel :	SO 416
Gasoil :	SN 017
Air1/Luft:	SA 14531
Hydraulic:	SH 74019
Pilot. :	SH 75079

LEITNER

LH 380

Type mach.	DAMEUSE
Mot.make	IVECO
Mot.energ.	DIESEL
Oil/Oel :	SO 287
Gasoil :	SN 037 PRIM
Gasoil :	SN 017 SECON
Hydraulic:	SH 63161

LH 400

Type mach.	DAMEUSE
Mot.make	FIAT
Mot.energ.	DIESEL
Oil/Oel :	SO 040
Gasoil :	SN 017
Air/Luft :	SA 19119 H:210MM OU/ODER
Air/Luft :	SA 14531 H:315MM OU/ODER
Air/Luft:	SAD 085012
Eau/Cool.:	WE 2069
Hydraulic:	SH 63161

LH 420 TURBO

Type mach.	DAMEUSE
Mot.make	IVECO
Mot.type	8936 SRI
Mot.energ.	DIESEL
Oil/Oel :	SO 417
Gasoil :	SN 037 PRIM
Gasoil :	SN 017 SECON
Air1/Luft:	SA 17019 H:285MM OU/ODER
Air1/Luft:	SA 19119 H:230MM
Eau/Cool.:	WE 2069
Hydraulic:	SH 74052
Hydraulic:	SH 75079 SUSPEN/FEDERUNG
Hydraulic:	SH 77013 ASP/SAUGFILT

LH 500

Type mach.	DAMEUSE
Mot.make	MAN
Mot.type	D 2866 LE
Mot.energ.	DIESEL
Oil/Oel :	SO 3327
Gasoil :	SN 70142 X2
Air1/Luft:	SA 14010 OU/ODER
Air1/Luft:	SA 10920 AVEC/MIT COUV/DECK
Hydraulic:	SH 52309 ANCIEN MONT.
Hydraulic:	SH 52278 NOUVEAU MONT.OU/ODER
Hydraulic:	SH 52049 H:302MM 10u
Hydraulic:	SH 75079 SUSPEN/FEDERUNG
Hydraulic:	SH 52516 TREUIL/WINDE

MEILI-V

VM 1300

Type mach.	DAMEUSE
Mot.make	VM
Mot.type	V65B13
Mot.energ.	DIESEL
Oil/Oel :	SO 242
Gasoil :	SN 327
Air/Luft :	SA 10716
Hydraulic:	SH 63161 X2

VM 1400

Type mach.	DAMEUSE
Mot.make	VM
Mot.energ.	DIESEL
Oil/Oel :	SO 242
Gasoil :	SN 327
Air1/Luft:	SA 14085
Air2/Luft:	SA 14472
Hydraulic:	SH 63161 X2

MEILI-V

VM 2000 PT

Type mach.	DAMEUSE
Mot.energ.	DIESEL
Oil/Oel :	SO 404
Gasoil :	SN 565

VM 2500 GT TURBO

Type mach.	DAMEUSE
Mot.make	VM
Mot.type	HR 694 HT
Mot.energ.	DIESEL
hp/kw	160HP/118KW
Oil/Oel :	SO 242
Gasoil :	SN 327

VM 3000

Type mach.	DAMEUSE
Mot.make	VM
Mot.energ.	DIESEL
Oil/Oel :	SO 242
Gasoil :	SN 327
Air/Luft :	SA 14008
Hydraulic:	SH 63161 X2

VM 3000 L

Type mach.	DAMEUSE
Mot.make	PERKINS
Mot.energ.	DIESEL
Oil/Oel :	SO 242
Gasoil :	SN 565

VM 500 MINI-TURBO

Type mach.	DAMEUSE
Mot.make	VW
Mot.type	2,0 TDI
Mot.energ.	DIESEL

VM 7000

Type mach.	DAMEUSE
Mot.make	VM
Mot.type	V 65 B 3
Mot.energ.	DIESEL
Oil/Oel :	SO 242
Gasoil :	SN 327
Air/Luft :	SA 14017
Hydraulic:	SH 63203 RESERVOIR/TANK
Hydraulic:	SH 63161

NEUSON

RK 20 S SNOWCAT

Type mach.	MINI DUMPER
Hydraulic:	SH 65014 RETOUR/RUCK
Hydraulic:	SH 77260 ASP/SAUGFILT
Aera/Vent:	FS 217 HYD

PAANA

VOIR AUSSI/SEE/SIEHE KASSBOHRER

Type mach.	.
------------	---

DAMEUSES | SNOW-GROOMING MACHINES | PISTENBULLY

PAANA

125	
Type mach.	DAMEUSE
Année->	2009
Mot.make	CUMMINS
Mot.type	QSB 4.5
Mot.energ.	DIESEL
hp/kw	115HP/85KW
Oil/Oel :	SO 10046
Gasoil :	SN 40602 PRIM
Gasoil :	SN 40529
Air1/Luft:	SA 16229
Air2/Luft:	SA 16265 OPTION
Hydraulic:	SH 56775
Hydraulic:	SH 74159 SP

200	
Type mach.	DAMEUSE
Mot.make	CUMMINS
Mot.type	6 BTA 5.9
Mot.energ.	DIESEL

PISTEN BULLY

VOIR/SEE/SIEHE KASSBOHRER

Type mach. .

PRINOTH

BEAST

Type mach.	DAMEUSE
Année->	2009
Mot.make	CATERPILLAR
Mot.type	C 13
Mot.energ.	DIESEL
hp/kw	527HP/393KW
Oil/Oel :	SO 10052
Oil/Oel :	SO 777 BY-PASS
Gasoil :	SN 40514 PREF/VORF
Gasoil :	SN 55429
Air/Luft :	SA 16359
Hydraulic:	SH 52131 +
Hydraulic:	SH 52933
Hydraulic:	SH 75004 V TREUIL/WINDE
Aera/Vent:	FS 268 HYD

BIG

Type mach.	DAMEUSE
Mot.make	DEUTZ
Oil/Oel :	SO 515
Gasoil :	SN 327

BISON

Type mach.	DAMEUSE
Année->	2007
Mot.make	CATERPILLAR
Mot.type	C 9
Mot.energ.	DIESEL
hp/kw	355HP/264KW
Oil/Oel :	SO 10052
Gasoil :	SN 909030 PRIM
Gasoil :	SN 55418 SECON
Air/Luft :	SA 160028
Hydraulic:	SH 52131 PPE TRACTION
Hydraulic:	SH 52933 PPE AUX
Hydraulic:	SH 75004 V TREUIL/WINDE
Aera/Vent:	FS 268 HYD

PRINOTH

BISON X	
Type mach.	DAMEUSE
Année->	2007
Mot.make	CATERPILLAR
Mot.type	C 9
Mot.energ.	DIESEL
hp/kw	355HP/264KW
Oil/Oel :	SO 10052
Gasoil :	SN 909030 PRIM
Gasoil :	SN 55418 SECON
Air/Luft :	SA 160028
Hydraulic:	SH 52131 PPE TRACTION
Hydraulic:	SH 52933 PPE AUX
Hydraulic:	SH 75004 V TREUIL/WINDE
Aera/Vent:	FS 268 HYD

EVEREST POWER

Type mach.	DAMEUSE
Mot.make	MERCEDES
Mot.type	OM 501 LA
Mot.energ.	DIESEL
Serie n°->	00301
->Serie n°	60153
Oil/Oel :	SO 7055
Gasoil :	SN 70141
Air1/Luft:	SA 14580
Hydraulic:	SH 52131 RETOUR/RUCK ->S00024
Hydraulic:	SH 74156 SP RETOUR/RUCK S00025->
Hydraulic:	SH 63071 X2 ASP/SAUGFILT X2
Hydraulic:	SH 52007 TREUIL/WINDE X2
Hydraulic:	SH 63612 X2
Dirac/Ste:	SH 75160 MOT/ENG
Aera/Vent:	SAO 5119 BY-PASS BIO
Hydraulic:	SH 70501

EVEREST POWER

Type mach.	DAMEUSE
Mot.make	MERCEDES
Mot.type	OM 501 LA
Mot.energ.	DIESEL
Serie n°->	60164
Oil/Oel :	SO 7055
Gasoil :	SN 916010 PREF/VORF
Gasoil :	SN 70141
Air1/Luft:	SA 14580
Hydraulic:	SH 74156 SP RETOUR/RUCK X2 ASP/SAUGFILT X2
Hydraulic:	SH 63071 X2
Hydraulic:	SH 52007 TREUIL/WINDE X2
Hydraulic:	SH 63612 X2
Dirac/Ste:	SH 75160 TR/WD DW60164->70368
Pilot. :	SH 52516 MOT/ENG
Aera/Vent:	SAO 5119 BY-PASS BIO
Hydraulic:	SH 70501

HUSKY

Type mach.	DAMEUSE
Année->	2005
Mot.make	MERCEDES
Mot.type	OM 904 LA
Mot.energ.	DIESEL
hp/kw	176HP/131KW
Oil/Oel :	SO 7081
Gasoil :	SN 70160 PREF/VORF
Gasoil :	SN 916010 20768-> PREF/VORF
Gasoil :	SN 70154
Air/Luft :	SA 11683 K ->20767
Air/Luft :	SA 10384 K 20768->
Hydraulic:	SH 52278 ->20767
Hydraulic:	SH 74187 SP 20768->
Hydraulic:	SH 74226 PREF/VORF O:81MM OU/
Hydraulic:	SH 74373 PREF/VORF O:110MM
Aera/Vent:	TCO 508 HYD

PRINOTH

HUSKY HK	
Type mach.	DAMEUSE
Année->	2019
Mot.make	MERCEDES
Mot.type	OM934LA-TIVF
Mot.energ.	DIESEL
Oil/Oel :	SO 7266
Ad blue :	KD 70436
Gasoil :	SN 70421 PREF/VORF
Gasoil :	KN 70434 SECON
Air1/Luft:	SA 16658
Hydraulic:	SH 74373 PREF/VORF
Hydraulic:	SH 74193 OPTION PPE TRACKTILL
Aera/Vent:	TCO 503 HYD

HUSKY HS

Type mach.	DAMEUSE
Année->	2015
Mot.make	MERCEDES
Mot.type	OM934LA-TIVF
Mot.energ.	DIESEL
Oil/Oel :	SO 7266
Ad blue :	KD 70436
Gasoil :	SN 70421 PREF/VORF
Gasoil :	KN 70434 SECON
Air1/Luft:	SA 16658
Hydraulic:	SH 74373 PREF/VORF
Hydraulic:	SH 74193 OPTION PPE TRACKTILL
Aera/Vent:	TCO 503 HYD

LEITWOLF

Type mach.	DAMEUSE
Année->	2002
->Année	2005
Mot.make	MAN
Mot.type	D2876LE103
Mot.energ.	DIESEL
hp/kw	435HP/324KW
Oil/Oel :	SO 3327
Gasoil :	MO 5302 PPE
Gasoil :	MO 7327 PREF/VORF
Gasoil :	SN 70142 X2
Air1/Luft:	SA 17281
Hydraulic:	SH 74186 SP +
Hydraulic:	SH 74193
Hydraulic:	SH 75079 SUSPEN/FEDERUNG
Hydraulic:	SH 75160 TREUIL/WINDE CW
Hydraulic:	SH 52516 TREUIL/WINDE DW

LEITWOLF

Type mach.	DAMEUSE
Année->	2006
Mot.make	MAN
Mot.type	D2876LE 122
Mot.energ.	DIESEL
Oil/Oel :	SO 3327
Gasoil :	RT 6 IN LINE
Gasoil :	SN 909030 PREF/VORF OU/ODER
Gasoil :	SN 916010 PREF/VORF
Gasoil :	SN 70186
Air1/Luft:	SA 17281
Hydraulic:	SH 74186 SP +
Hydraulic:	SH 74193
Hydraulic:	SH 75079 SUSPEN/FEDERUNG
Hydraulic:	SH 75160 TREUIL/WINDE CW
Hydraulic:	SH 52516 TREUIL/WINDE DW
Gasoil :	SN 70283 PPE PREF/VORF

PRINOTH

NEW BISON X/XP

Type mach.	DAMEUSE
Année->	2016
Mot.make	CATERPILLAR
Mot.type	C9.3 ACERT
Mot.energ.	DIESEL
hp/kw	406HP/302KW
Oil/Oel :	SO 10052
Gasoil :	SN 55438 PRIM
Gasoil :	SN 55418 X2 SECON
Air1/Luft:	SA 16776
Air2/Luft:	SA 16777 OPTION
Hydraulic:	SH 52291 PPE
Hydraulic:	SH 52330 ACCESSOIRES
Hydraulic:	SH 75004 V TREUIL/WINDE
Aera/Vent:	FS 268 HYD

NEW HUSKY

Type mach.	DAMEUSE
Année->	2016
Mot.make	MERCEDES
Mot.type	OM934LA
Mot.energ.	DIESEL
hp/kw	231HP/172KW
Oil/Oel :	SO 7266
Ad blue :	KD 70436
Gasoil :	SN 70421 PREF/VORF
Gasoil :	KN 70434 SECON
Air1/Luft:	SA 16658
Hydraulic:	SH 52291

NEW LEITWOLF

Type mach.	DAMEUSE
Année->	2011
Mot.make	MERCEDES
Mot.type	OM 460LA EURO4
Mot.energ.	DIESEL
Oil/Oel :	SO 7139
Ad blue :	KD 70322
Gasoil :	SN 70284 PREF/VORF
Gasoil :	SN 916010 PRIM
Gasoil :	SN 70141 SECON
Air1/Luft:	SA 17278
Hydraulic:	SH 74193 RETOUR/RUCK
Hydraulic:	SH 75004 V TREUIL/WINDE
Hydraulic:	SH 75212 V PPE AUX
Hydraulic:	SH 74400 SPV PPE DRAIN
Hydraulic:	SH 74186 SP ASP/SAUGFILT
Dessic/Dr:	TB 1390
Aera/Vent:	SAO 5351 MOT/ENG

NEW LEITWOLF

Type mach.	DAMEUSE
Année->	2014
Mot.make	MERCEDES
Mot.type	OM 460LA EURO4
Mot.energ.	DIESEL
Oil/Oel :	SO 7139
Ad blue :	KD 70322
Gasoil :	SN 70284 PREF/VORF
Gasoil :	SN 916010 PRIM
Gasoil :	SN 70141 SECON
Air1/Luft:	SA 17278
Hydraulic:	SH 74193 RETOUR/RUCK
Hydraulic:	SH 75004 V TREUIL/WINDE
Hydraulic:	SH 75212 V PPE AUX
Hydraulic:	SH 74400 SPV PPE DRAIN
Hydraulic:	SH 74186 SP ASP/SAUGFILT
Dessic/Dr:	TB 1390
Aera/Vent:	SAO 5351 MOT/ENG
Hydraulic:	SH 74518 RETOUR/RUCK H:215MM
Hydraulic:	SH 75353 ACCESSOIRES

PRINOTH

NEW LEITWOLF

Type mach.	DAMEUSE
Année->	2018
Mot.make	MTU
Mot.type	6R1300
Oil/Oel :	SO 7238
Ad blue :	KD 70436
Gasoil :	MO 7001 PREF/VORF
Gasoil :	SN 70399
Air1/Luft:	SA 17446
Eau/Cool.:	EZ 06832 TREUIL/WINDE
Hydraulic:	SH 74186 SP ASP/SAUGFILT
Hydraulic:	SH 74518 RETOUR/RUCK
Hydraulic:	SH 75004 V TREUIL/WINDE
Hydraulic:	SH 75353 PRESSION/DRUCK

NEW LEITWOLF LE

Type mach.	DAMEUSE
Année->	2011
Mot.make	MERCEDES
Mot.type	OM 460LA EURO3B
Mot.energ.	DIESEL
Oil/Oel :	SO 7139
Ad blue :	KD 70322 ->2015
Ad blue :	KD 70436 2015-> KIT
Ad blue :	SD 70466 2015-> CART/EINS
Gasoil :	SN 70284 PREF/VORF
Gasoil :	SN 916010 PRIM
Gasoil :	SN 70141 SECON
Air1/Luft:	SA 17278
Hydraulic:	SH 74193 RETOUR/RUCK
Hydraulic:	SH 75004 V TREUIL/WINDE
Hydraulic:	SH 75212 V PPE AUX
Hydraulic:	SH 74400 SPV PPE DRAIN
Hydraulic:	SH 74186 SP ASP/SAUGFILT
Dessic/Dr:	TB 1390
Aera/Vent:	SAO 5351 MOT/ENG

NEW LEITWOLF LE

Type mach.	DAMEUSE
Année->	2014
Mot.make	MERCEDES
Mot.type	OM 460LA EURO4
Mot.energ.	DIESEL
Oil/Oel :	SO 7139
Ad blue :	KD 70322 ->2015
Ad blue :	KD 70436 2015-> KIT
Ad blue :	SD 70466 2015-> CART/EINS
Gasoil :	SN 70284 PREF/VORF
Gasoil :	SN 916010 PRIM
Gasoil :	SN 70141 SECON
Air1/Luft:	SA 17278
Hydraulic:	SH 74193 RETOUR/RUCK
Hydraulic:	SH 75004 V TREUIL/WINDE
Hydraulic:	SH 75212 V PPE AUX
Hydraulic:	SH 74400 SPV PPE DRAIN
Hydraulic:	SH 74186 SP ASP/SAUGFILT
Dessic/Dr:	TB 1390
Aera/Vent:	SAO 5351 MOT/ENG
Hydraulic:	SH 74518 RETOUR/RUCK H:215MM
Hydraulic:	SH 75353 ACCESSOIRES

PRINOTH

NEW LEITWOLF LI

Type mach.	DAMEUSE
Année->	2016
Mot.make	MERCEDES
Mot.type	OM 471 LA T IV
Mot.energ.	DIESEL
hp/kw	530HP/395KW
Oil/Oel :	SO 7238
Ad blue :	KD 70436 KIT OU/ODER
Ad blue :	SD 70466 CART/EINS
Gasoil :	KN 70416
Air1/Luft:	SA 17446
Hydraulic:	SH 74186 SP
Hydraulic:	SH 74518 RETOUR/RUCK
Hydraulic:	SH 75004 V TREUIL/WINDE
Hydraulic:	SH 74373

PANTHER T14 R

Type mach.	DUMPER
Mot.make	CATERPILLAR
Mot.type	C7.1 ACERT
Mot.energ.	DIESEL
Oil/Oel :	SO 11092
Gasoil :	SN 40718 PREF/VORF IN LINE
Gasoil :	SN 40678 PRIM
Gasoil :	SN 40679 SECON
Air1/Luft:	SA 16472
Air2/Luft:	SA 16508
Hydraulic:	SH 52131 RETOUR/RUCK
Hydraulic:	SH 52933 PRESSION/DRUCK

PANTHER T6

Type mach.	DUMPER
Mot.make	CATERPILLAR
Mot.type	C4.4
Mot.energ.	DIESEL
Oil/Oel :	SO 242
Gasoil :	SN 30040 PRIM
Gasoil :	SN 30036 SECON
Air1/Luft:	SA 16460
Air2/Luft:	SA 16414
Hydraulic:	SH 52291

PANTHER T8

Type mach.	DUMPER
Mot.make	CATERPILLAR
Mot.type	C7.1 TIERIV
Mot.energ.	DIESEL
Oil/Oel :	SO 11092
Gasoil :	SN 40679 PRIM
Gasoil :	SN 40678 SECON
Air1/Luft:	SA 16472
Air2/Luft:	SA 16508
Hydraulic:	SH 52291
Aera/Vent:	FS 268 HYD

S/JUNIOR

Type mach.	DAMEUSE
Mot.make	DEUTZ
Mot.energ.	DIESEL
Oil/Oel :	SO 515
Gasoil :	SN 327
Air1/Luft:	SA 19417
Hydraulic:	SH 63161 X2

T 2

Type mach.	DAMEUSE
Mot.make	VM
Mot.energ.	DIESEL
Oil/Oel :	SO 242
Gasoil :	SN 327
Air1/Luft:	SA 19415 O:168MM OU/ODER
Air1/Luft:	SA 19417 O:206MM
Hydraulic:	SH 63201 X2

DAMEUSES | SNOW-GROOMING MACHINES | PISTENBULLY

PRINOTH

T 2 S

Type mach.	DAMEUSE	
Mot.make	VM	
Mot.energ.	DIESEL	
Oil/Oel :	SO 242	
Gasoil :	SN 039	
Air1/Luft:	SA 11683 K	
Hydraulic:	SH 52309	ANCIEN MONT.
Hydraulic:	SH 52278	NOUVEAU MONT.

T 2 X

Type mach.	DAMEUSE	
Mot.make	MERCEDES	
Mot.energ.	DIESEL	
Oil/Oel :	SO 7081	
Gasoil :	SN 70160	PREF/VORF
Gasoil :	SN 70154	
Air1/Luft:	SA 11683 K	
Hydraulic:	SH 52309	ANCIEN MONT.
Hydraulic:	SH 52278	NOUVEAU MONT.

T 3

Type mach.	DAMEUSE	
Mot.make	DEUTZ	
Mot.energ.	DIESEL	

T 4

Type mach.	DAMEUSE	
Mot.make	SCANIA	
Mot.energ.	DIESEL	
Oil/Oel :	SO 3376	
Gasoil :	SN 5074	X2
Air1/Luft:	SA 19416	
Eau/Cool.:	WE 2142	
Hydraulic:	SH 75062	H:329MM X2 +
Hydraulic:	SH 75014	H:154MM +
Hydraulic:	SH 75030	H:115MM

T 4 S

Type mach.	DAMEUSE	
Mot.make	SCANIA	
Mot.type	DSC 9	
Mot.energ.	DIESEL	
Oil/Oel :	SO 3376	
Gasoil :	SN 5074	X2
Air1/Luft:	SA 19416	H:340MM OU/ODER
Air1/Luft:	SA 19417	H:380MM
Eau/Cool.:	WE 2142	
Hydraulic:	SH 52309	ANCIEN MONT.
Hydraulic:	SH 52278	NOUVEAU MONT.+
Hydraulic:	SH 52007	H:169MM
Hydraulic:	SH 63071	

T 4 SRW/SRP

Type mach.	DAMEUSE	
Année->	2004	
Mot.make	SCANIA	
Oil/Oel :	SO 3730	+
Oil/Oel :	JR 110720353 B	JOINT/GASKET +
Oil/Oel :	JR 129770353 B	JOINT/GASKET
Gasoil :	SN 5297	
Air/Luft :	SA 19416	
Hydraulic:	SH 52309	RETOUR/RUCK
Hydraulic:	SH 63071	ASP/SAUGFILT
Hydraulic:	SH 52131	HUILE/OIL BIO
Hydraulic:	SH 52007	ADDITZUSATZ

PRINOTH

T 4 SW

Type mach.	DAMEUSE	
Mot.make	SCANIA	
Oil/Oel :	SO 3376	
Gasoil :	SN 5297	X2
Air1/Luft:	SA 19416	
Hydraulic:	SH 52007	+
Hydraulic:	SH 52309	+
Hydraulic:	SH 63071	

TC

Type mach.	DAMEUSE	
Mot.make	MERCEDES	
Oil/Oel :	SO 7001	
Gasoil :	SN 090	X2
Air1/Luft:	SA 19416	
Hydraulic:	SH 75030	H:115MM +
Hydraulic:	SH 75046	H:160MM
Hydraulic:	SH 56771	VISSE/SCHR

TCS

Type mach.	DAMEUSE	
Mot.make	SCANIA	
Oil/Oel :	SO 3376	
Gasoil :	SN 5074	X2
Air1/Luft:	SA 19416	
Eau/Cool.:	WE 2142	
Hydraulic:	SH 52309	ANCIEN MONT.
Hydraulic:	SH 52278	NOUVEAU MONT.+
Hydraulic:	SH 52007	H:169MM
Hydraulic:	SH 63071	

TR TAXI NEIGE

Type mach.	DAMEUSE	
Mot.make	MERCEDES	
Mot.type	OM 603	
Oil/Oel :	SO 941	
Gasoil :	SN 532	
Air1/Luft:	SA 11551	

TROOPER

Type mach.	TRANSPORTEUR	
Mot.make	PERKINS	
Mot.type	1104D-E44TA	

200

Type mach.	DAMEUSE	
Mot.make	DEUTZ	
Oil/Oel :	SO 515	
Gasoil :	SN 327	
Hydraulic:	SH 63161	10µ +
Hydraulic:	SH 63166	60µ

RATRAC

VOIR AUSSI/SEE/SIEHE ROLBA

HYDRO-TURBO 80

Type mach.	DAMEUSE	
Mot.make	ALLIS CHALMERS	
Oil/Oel :	SO 517	
Gasoil :	SN 5020	PRIM
Gasoil :	SN 5019	SECON
Hydraulic:	SH 63161	

RATRAC

HYDRO-TURBO 81

Type mach.	DAMEUSE	
Mot.make	ALLIS CHALMERS	
Oil/Oel :	SO 517	
Gasoil :	SN 5020	PRIM
Gasoil :	SN 5019	SECON
Hydraulic:	SH 56760	

TURBOTRAC 260

Type mach.	DAMEUSE	
Mot.make	CATERPILLAR	
Mot.type	3208	
Oil/Oel :	SO 3328	X2
Gasoil :	SN 1205	PREF/VORF
Gasoil :	SN 185	
Air1/Luft:	SA 11770	
Hydraulic:	SH 64753	X3 +
Hydraulic:	SH 64527	
Pilot. :	SH 64184	

1800

Type mach.	DAMEUSE	
Mot.make	CATERPILLAR	
Mot.type	3116 T	
Oil/Oel :	SO 667	
Gasoil :	SN 1205	PREF/VORF
Gasoil :	SN 185	

3700 CFS

Type mach.	DAMEUSE	
Mot.make	CATERPILLAR	
Mot.type	3176	
Oil/Oel :	SO 691	H:287MM OU/ODER
Oil/Oel :	SO 3328	H:167MM
Gasoil :	SN 5019	PREF/VORF OU/ODER
Gasoil :	SN 1205	PREF/VORF
Gasoil :	SN 194	
Hydraulic:	SH 56760	X2 +
Hydraulic:	SH 63161	

ROLBA

VOIR AUSSI/SEE/SIEHE RATRAC

Type mach. .

TURBOTRAC 140

Type mach.	DAMEUSE	
Mot.make	VM	
Mot.type	HR 692 HT	
Mot.energ.	DIESEL	
Oil/Oel :	SO 242	
Gasoil :	SN 327	
Air1/Luft:	SA 10300 K	
Hydraulic:	SH 63161	X3

TURBOTRAC 150

Type mach.	DAMEUSE	
Mot.make	VM	
Mot.type	HR 692 HT	
Mot.energ.	DIESEL	
Oil/Oel :	SO 242	
Gasoil :	SN 327	
Air1/Luft:	SA 16554	
Hydraulic:	SH 63161	

ROLBA

TURBOTRAC 260

Type mach.	DAMEUSE	
Mot.make	CATERPILLAR	
Mot.type	3208	
Mot.energ.	DIESEL	
Oil/Oel :	SO 3328	X2
Gasoil :	SN 1205	PREF/VORF
Gasoil :	SN 185	
Air1/Luft:	SA 11770	
Hydraulic:	SH 64753	X3 +
Hydraulic:	SH 64527	
Pilot. :	SH 64184	

TURBOTRAC 280

Type mach.	DAMEUSE
Mot.make	CATERPILLAR
Mot.energ.	DIESEL
hp/kw	280HP/208KW

SHANTUI

DLY 100

Type mach.	TRANSPORTEUR	
Mot.make	CUMMINS	
Mot.type	4BT3.9	
Mot.energ.	DIESEL	
Oil/Oel :	SO 3345	
Gasoil :	SN 5038	PRIM
Gasoil :	SN 5052	SECON

STAHL PIST.FAHRZEUGE

PR 250



















Type mach.	DAMEUSE
------------	---------





PRW 42.280

Type mach.	DAMEUSE
Mot.make	DAF
Mot.type	HS 206 G
Mot.energ.	DIESEL
Oil/Oel :	SO 040
Gasoil :	SN 4070



DAMEUSES | SNOW-GROOMING MACHINES | PISTENBULLY

<p>AZTEC</p> <p>SA 16474</p> <p>FILTRE A AIR AIR FILTER LUFTFILTER</p> <p>H : 239 mm Ø : 385 mm ø : 260 mm</p> 	<p>BOMBARDIER</p> <p>SH 52131</p> <p>FILTRE HYDRAULIQUE HYDRAULIC FILTER HYDRAULIKFILTER</p> <p>H : 398 / 393 mm Ø : 90 mm ø : 39.5 mm</p> 	<p>BOMBARDIER</p> <p>SH 84018</p> <p>FILTRE HYDRAULIQUE HYDRAULIC FILTER HYDRAULIKFILTER</p> <p>H : 94 mm Ø : 47 mm ø : 25 mm</p> 
<p>SH 74248 SP</p> <p>FILTRE HYDRAULIQUE HYDRAULIC FILTER HYDRAULIKFILTER</p> <p>H : 318 / 301 mm Ø : 114 mm ø : 67 / 67 mm</p> 	<p>SH 52933</p> <p>FILTRE HYDRAULIQUE HYDRAULIC FILTER HYDRAULIKFILTER</p> <p>H : 328 mm Ø : 89 mm ø : 50 / 50 mm</p> 	<p>SN 40514</p> <p>FILTRE A GASOIL FUEL FILTER KRAFTSTOFF-FILTER</p> <p>H : 240 mm Ø : 94 / 94 mm ø : 1"-14UNF / M14X2</p> 
<p>SN 55429</p> <p>FILTRE A GASOIL FUEL FILTER KRAFTSTOFF-FILTER</p> <p>H : 272 mm Ø : 94 mm ø : 1"-14UNF</p> 	<p>SH 56560</p> <p>FILTRE HYDRAULIQUE HYDRAULIC FILTER HYDRAULIKFILTER</p> <p>H : 146 / 144 mm Ø : 94 / 93 mm ø : 1"-12UNF</p> 	<p>SN 5019</p> <p>FILTRE A GASOIL FUEL FILTER KRAFTSTOFF-FILTER</p> <p>H : 202.5 / 200.5 mm Ø : 111 / 108 mm ø : 7/8"-14UNF</p> 
<p>SN 912010</p> <p>FILTRE A GASOIL SEPARATEUR D'EAU FUEL WATER SEPARATOR FILTER ABSCHIEDER DIESELFILTER</p> <p>H : 219 / 216 mm Ø : 111 / 108 mm ø : 1"-14UNF / M95X2,5</p> <p>10µ_BOL/GLASS BOWL: Y RK30063</p> 	<p>SH 63076</p> <p>FILTRE HYDRAULIQUE HYDRAULIC FILTER HYDRAULIKFILTER</p> <p>H : 89 / 83.5 mm Ø : 44 mm ø : 21 mm</p> 	<p>SN 5038</p> <p>FILTRE A GASOIL FUEL FILTER KRAFTSTOFF-FILTER</p> <p>H : 161 / 142 mm Ø : 93 / 90 mm ø : 13/16"-18UN</p> 
<p>SO 10052</p> <p>FILTRE A HUILE OIL FILTER OELFILTER</p> <p>H : 308 / 305 mm Ø : 138 / 136 mm ø : 1"1/2-16UNF</p> 	<p>SH 66542</p> <p>FILTRE HYDRAULIQUE HYDRAULIC FILTER HYDRAULIKFILTER</p> <p>H : 154 / 153 mm Ø : 98 mm ø : 1"3/8-12UNF</p> 	<p>SN 5052</p> <p>FILTRE A GASOIL FUEL FILTER KRAFTSTOFF-FILTER</p> <p>H : 123 / 121 mm Ø : 78.5 / 77 mm ø : M16X1,5</p> 
<p>BOMBARDIER</p> <p>SA 11763</p> <p>FILTRE A AIR AIR FILTER LUFTFILTER</p> <p>H : 470 / 457 mm Ø : 210 / 182 mm ø : 120 / 16 mm</p> 	<p>SH 74121</p> <p>FILTRE HYDRAULIQUE HYDRAULIC FILTER HYDRAULIKFILTER</p> <p>H : 412 / 386 mm Ø : 114 mm ø : 66.5 mm</p> 	<p>SN 5074</p> <p>FILTRE A GASOIL FUEL FILTER KRAFTSTOFF-FILTER</p> <p>H : 123 / 120 mm Ø : 78 / 76 mm ø : M16X1,5</p> 



















BOMBARDIER	BOMBARDIER	FORMATIC
<p>SN 5269 FILTRE A GASOIL FUEL FILTER KRAFTSTOFF-FILTER</p> <p>H : 167 / 165 mm Ø : 109 / 108 mm ø : 7/8"-14UNF</p> 	<p>SO 4017 FILTRE A HUILE OIL FILTER OELFILTER</p> <p>H : 189 / 187 mm Ø : 98 / 96 mm ø : 1"-12UNF</p> 	<p>SA 16120 FILTRE A AIR AIR FILTER LUFTFILTER</p> <p>H : 521 mm Ø : 311 mm ø : 180 mm</p> 
<p>SN 55002 FILTRE A GASOIL FUEL FILTER KRAFTSTOFF-FILTER</p> <p>H : 131 / 117 mm Ø : 108 / 108 mm ø : 1"-14UNF / M95X2,5</p> 	<p>SO 734 FILTRE A HUILE OIL FILTER OELFILTER</p> <p>H : 203 / 201 mm Ø : 123 / 120 mm ø : 1"1/2"-12UNF</p> 	<p>SA 16121 FILTRE A AIR AIR FILTER LUFTFILTER</p> <p>H : 508 / 502 mm Ø : 178 / 172 mm ø : 145 mm</p> 
<p>SO 10011 FILTRE A HUILE OIL FILTER OELFILTER</p> <p>H : 300 / 294 mm Ø : 119 / 119 mm ø : 2"1/4"-12UNF</p> 	<p>WE 2071 FILTRE EAU MOTEUR COOLANT FILTER KÜHL FLÜSSIGKEITFILTER</p> <p>H : 106 / 104 mm Ø : 95 / 93 mm ø : 11/16"-16UN</p> 	<p>SA 16125 FILTRE A AIR AIR FILTER LUFTFILTER</p> <p>H : 524 mm Ø : 280 mm ø : 150 mm</p> 
<p>SO 180 FILTRE A HUILE OIL FILTER OELFILTER</p> <p>H : 265 / 262 mm Ø : 111 / 109 mm ø : 1"1/8"-16UNF</p> 	<p>WE 2073 FILTRE EAU MOTEUR COOLANT FILTER KÜHL FLÜSSIGKEITFILTER</p> <p>H : 105 / 103 mm Ø : 94 / 93 mm ø : 11/16"-16UN</p> 	<p>SA 16127 FILTRE A AIR AIR FILTER LUFTFILTER</p> <p>H : 500 / 495 mm Ø : 149 / 140 mm ø : 111 mm</p> 
<p>SO 3000 FILTRE A HUILE OIL FILTER OELFILTER</p> <p>H : 301 / 295 mm Ø : 119 mm ø : 2"1/4"-12UNF</p> 	<p>WE 2074 FILTRE EAU MOTEUR COOLANT FILTER KÜHL FLÜSSIGKEITFILTER</p> <p>H : 137 / 135 mm Ø : 94 / 93 mm ø : 11/16"-16UN</p> 	<p>SA 17440 FILTRE A AIR AIR FILTER LUFTFILTER</p> <p>H : 333 / 322 mm Ø : 172 / 154 mm ø : 67 / 9 mm</p> 
<p>SO 3640 FILTRE A HUILE OIL FILTER OELFILTER</p> <p>H : 304 / 302.5 mm Ø : 137 / 135 mm ø : M36X1,5</p> 	<p>WE 2104 FILTRE EAU MOTEUR COOLANT FILTER KÜHL FLÜSSIGKEITFILTER</p> <p>H : 137 / 135 mm Ø : 94.5 / 93.5 mm ø : 11/16"-16UN</p> 	<p>SH 55500 FILTRE HYDRAULIQUE HYDRAULIC FILTER HYDRAULIKFILTER</p> <p>H : 92 mm Ø : 73 mm ø : 32 / 27 mm</p> 







FORMATIC	FORMATIC	FORMATIC
<p>SH 63061</p> <p>FILTRE HYDRAULIQUE HYDRAULIC FILTER HYDRAULIKFILTER</p> <p>H : 143 / 141 mm Ø : 98 / 95 mm ø : 3/4"-BSP</p> 	<p>SN 40602</p> <p>FILTRE A GASOIL FUEL FILTER KRAFTSTOFF-FILTER</p> <p>H : 201 / 164 mm Ø : 94 / 94 mm ø : 1"-14UNF</p> 	<p>WE 2075</p> <p>FILTRE EAU MOTEUR COOLANT FILTER KÜHL FLÜSSIGKEITFILTER</p> <p>H : 141 / 139 mm Ø : 95.5 / 93.5 mm ø : 11/16"-16UN</p> 
<p>SH 63161</p> <p>FILTRE HYDRAULIQUE HYDRAULIC FILTER HYDRAULIKFILTER</p> <p>H : 177 / 175 mm Ø : 128 / 127 mm ø : 1"1/4-BSP</p> 	<p>SN 40606</p> <p>FILTRE A GASOIL FUEL FILTER KRAFTSTOFF-FILTER</p> <p>H : 176 / 175 mm Ø : 94 / 94 mm ø : 7/8"-14UNF</p> 	<p>WE 2076</p> <p>FILTRE EAU MOTEUR COOLANT FILTER KÜHL FLÜSSIGKEITFILTER</p> <p>H : 142 / 141 mm Ø : 96 / 94.5 mm ø : 11/16"-16UN</p> 
<p>SH 74156 SP</p> <p>FILTRE HYDRAULIQUE HYDRAULIC FILTER HYDRAULIKFILTER</p> <p>H : 318 / 301 mm Ø : 114 mm ø : 67 / 67 mm</p> 	<p>SO 10011</p> <p>FILTRE A HUILE OIL FILTER OELFILTER</p> <p>H : 300 / 294 mm Ø : 119 / 119 mm ø : 2"1/4-12UNF</p> 	<p>KASSBOHRER</p> <p>FS 268</p> <p>FILTRE AERATION COMPLET BREATHER FILTER BELÜFTUNGSFILTER</p> <p>H : 70 / 50 mm Ø : 80.5 mm ø : M42X2</p> 
<p>SN 001</p> <p>FILTRE A GASOIL FUEL FILTER KRAFTSTOFF-FILTER</p> <p>H : 72 mm Ø : 87 / 84 mm ø : 19 mm</p> 	<p>SO 10020</p> <p>FILTRE A HUILE OIL FILTER OELFILTER</p> <p>H : 300 mm Ø : 119 mm ø : M95X2,5</p> 	<p>KD 70322</p> <p>KIT FILTRE A UREE UREA FILTER KIT HARNSTOFFFILTER-KIT</p> <p>H : 99 / 82 mm Ø : 72 / 59 mm</p> 
<p>SN 1212</p> <p>FILTRE A GASOIL FUEL FILTER KRAFTSTOFF-FILTER</p> <p>H : 191 / 172 mm Ø : 94 / 94 mm ø : 1"-14UNF</p> 	<p>SO 3000</p> <p>FILTRE A HUILE OIL FILTER OELFILTER</p> <p>H : 301 / 295 mm Ø : 119 mm ø : 2"1/4-12UNF</p> 	<p>SA 10300 K</p> <p>FILTRE A AIR AIR FILTER LUFTFILTER</p> <p>H : 269 / 259 mm Ø : 248 / 198 mm ø : 90 / 12 mm</p> 
<p>SN 40512</p> <p>FILTRE A GASOIL FUEL FILTER KRAFTSTOFF-FILTER</p> <p>H : 250 / 230 mm Ø : 93 / 93 mm ø : 1"-14UNF</p> 	<p>SO 8590</p> <p>FILTRE A HUILE OIL FILTER OELFILTER</p> <p>H : 79 / 76 mm Ø : 79 / 76 mm ø : 3/4"-16UNF</p> 	<p>SA 10920</p> <p>FILTRE A AIR AIR FILTER LUFTFILTER</p> <p>H : 495 / 483 mm Ø : 308 / 242 mm ø : 131 / 10 mm</p> 



















KASSBOHRER	KASSBOHRER	KASSBOHRER
<p>SA 11551</p> <p>FILTRE A AIR AIR FILTER LUFTFILTER</p> <p>H : 373 / 366 mm Ø : 250 / 198 mm ø : 104 / 8 mm</p> 	<p>SA 14019</p> <p>FILTRE A AIR AIR FILTER LUFTFILTER</p> <p>H : 382 / 370 mm Ø : 226 mm ø : 117 / 10 mm</p> 	<p>SA 17281</p> <p>FILTRE A AIR AIR FILTER LUFTFILTER</p> <p>H : 365 / 325 mm Ø : 247 mm ø : 150 mm</p> 
<p>SA 11552</p> <p>FILTRE A AIR AIR FILTER LUFTFILTER</p> <p>H : 378 / 371 mm Ø : 276 / 227 mm ø : 117 / 10 mm</p> 	<p>SA 16125</p> <p>FILTRE A AIR AIR FILTER LUFTFILTER</p> <p>H : 524 mm Ø : 280 mm ø : 150 mm</p> 	<p>SA 17321</p> <p>FILTRE A AIR AIR FILTER LUFTFILTER</p> <p>H : 305 / 265 mm Ø : 227 mm ø : 130 mm</p> 
<p>SA 11752</p> <p>FILTRE A AIR AIR FILTER LUFTFILTER</p> <p>H : 475 / 461 mm Ø : 302 mm ø : 190 / 12 mm</p> 	<p>SA 16229</p> <p>FILTRE A AIR AIR FILTER LUFTFILTER</p> <p>H : 396 / 388 mm Ø : 185 mm ø : 107 mm</p> 	<p>SA 606</p> <p>FILTRE A AIR AIR FILTER LUFTFILTER</p> <p>H : 109 / 100 mm Ø : 308 mm ø : 224 / 224 mm</p> 
<p>SA 13990</p> <p>FILTRE A AIR AIR FILTER LUFTFILTER</p> <p>H : 376 / 366 mm Ø : 198 mm ø : 103 / 8.5 mm</p> 	<p>SA 16265</p> <p>FILTRE A AIR AIR FILTER LUFTFILTER</p> <p>H : 381 / 375 mm Ø : 105 mm ø : 87 mm</p> 	<p>SAO 5369</p> <p>FILTRE AERATION MOTEUR ENGINE BREATHER FILTER MOTORENTLÜFTUNG FILTER</p> <p>H : 81 mm Ø : 145 / 117 mm ø : M41X1,5</p> 
<p>SA 14010</p> <p>FILTRE A AIR AIR FILTER LUFTFILTER</p> <p>H : 495 / 485 mm Ø : 242 mm ø : 132 / 10.5 mm</p> 	<p>SA 17100</p> <p>FILTRE A AIR AIR FILTER LUFTFILTER</p> <p>H : 361 / 352 mm Ø : 148 mm ø : 88 mm</p> 	<p>SD 70380</p> <p>FILTRE A UREE UREA FILTER HARNSTOFFFILTER</p> <p>H : 93 mm Ø : 50 / 4.5 mm ø : 23 mm</p> 
<p>SA 14017</p> <p>FILTRE A AIR AIR FILTER LUFTFILTER</p> <p>H : 296 / 285 mm Ø : 126 mm ø : 64 / 8.5 mm</p> 	<p>SA 17278</p> <p>FILTRE A AIR AIR FILTER LUFTFILTER</p> <p>H : 480 / 438 mm Ø : 265 mm ø : 170 mm</p> 	<p>SD 70382</p> <p>FILTRE A UREE UREA FILTER HARNSTOFFFILTER</p> <p>H : 35 mm Ø : 6.6 / 4.5 mm ø : 1.5 mm</p> 





















KASSBOHRER	KASSBOHRER	KASSBOHRER
<p>SH 52019</p> <p>FILTRE HYDRAULIQUE HYDRAULIC FILTER HYDRAULIKFILTER</p> <p>H : 328 mm Ø : 110 mm ø : 72 / 72 mm</p> 	<p>SH 52933</p> <p>FILTRE HYDRAULIQUE HYDRAULIC FILTER HYDRAULIKFILTER</p> <p>H : 328 mm Ø : 89 mm ø : 50 / 50 mm</p> 	<p>SH 74186 SP</p> <p>FILTRE HYDRAULIQUE HYDRAULIC FILTER HYDRAULIKFILTER</p> <p>H : 392 mm Ø : 88 mm ø : 39 / 39 mm</p> 
<p>SH 52209</p> <p>FILTRE HYDRAULIQUE HYDRAULIC FILTER HYDRAULIKFILTER</p> <p>H : 228 mm Ø : 83 mm ø : 59 / 59 mm</p> 	<p>SH 56775</p> <p>FILTRE HYDRAULIQUE HYDRAULIC FILTER HYDRAULIKFILTER</p> <p>H : 169 mm Ø : 129 / 127 mm ø : 1"1/2-16UNF</p> 	<p>SH 77250</p> <p>FILTRE HYDRAULIQUE HYDRAULIC FILTER HYDRAULIKFILTER</p> <p>H : 81 / 72 mm Ø : 44 mm ø : 1/2"-BSP</p> 
<p>SH 52247</p> <p>FILTRE HYDRAULIQUE HYDRAULIC FILTER HYDRAULIKFILTER</p> <p>H : 200 / 196 mm Ø : 45.5 mm ø : 19.5 mm</p> 	<p>SH 62305</p> <p>FILTRE HYDRAULIQUE HYDRAULIC FILTER HYDRAULIKFILTER</p> <p>H : 8 / 4 mm Ø : 12 mm</p> 	<p>SH 77254</p> <p>FILTRE HYDRAULIQUE HYDRAULIC FILTER HYDRAULIKFILTER</p> <p>H : 92 / 75 mm Ø : 100 mm ø : 1"1/2-BSP</p> 
<p>SH 52300</p> <p>FILTRE HYDRAULIQUE HYDRAULIC FILTER HYDRAULIKFILTER</p> <p>H : 300 mm Ø : 95 mm ø : 59 / 59 mm</p> 	<p>SH 64179</p> <p>FILTRE HYDRAULIQUE HYDRAULIC FILTER HYDRAULIKFILTER</p> <p>H : 69 mm Ø : 30 mm ø : 15.5 mm</p> 	<p>SH 77255</p> <p>FILTRE HYDRAULIQUE HYDRAULIC FILTER HYDRAULIKFILTER</p> <p>H : 92 / 82 mm Ø : 99 mm ø : 2"-BSP</p> 
<p>SH 52301</p> <p>FILTRE HYDRAULIQUE HYDRAULIC FILTER HYDRAULIKFILTER</p> <p>H : 228.5 mm Ø : 83 mm ø : 50 / 50 mm</p> 	<p>SH 74159 SP</p> <p>FILTRE HYDRAULIQUE HYDRAULIC FILTER HYDRAULIKFILTER</p> <p>H : 336 / 325 mm Ø : 95 mm ø : 47.5 / 47.5 mm</p> 	<p>SH 77256</p> <p>FILTRE HYDRAULIQUE HYDRAULIC FILTER HYDRAULIKFILTER</p> <p>H : 133 / 113 mm Ø : 70 mm ø : 1"-BSP</p> 
<p>SH 52309</p> <p>FILTRE HYDRAULIQUE HYDRAULIC FILTER HYDRAULIKFILTER</p> <p>H : 333 / 329 mm Ø : 90 mm ø : 39.5 mm</p> 	<p>SH 74169 SP</p> <p>FILTRE HYDRAULIQUE HYDRAULIC FILTER HYDRAULIKFILTER</p> <p>H : 221 mm Ø : 88 mm ø : 39 / 39 mm</p> 	<p>SN 039</p> <p>FILTRE A GASOIL FUEL FILTER KRAFTSTOFF-FILTER</p> <p>H : 122 / 120 mm Ø : 81 / 78 mm ø : M16X1,5</p> 

KASSBOHRER	KASSBOHRER	KASSBOHRER
<p>SN 066 FILTRE A GASOIL FUEL FILTER KRAFTSTOFF-FILTER</p>  <p>H : 144 / 130 mm Ø : 83 mm ø : 11 / 11 mm</p>	<p>SN 268 FILTRE A GASOIL FUEL FILTER KRAFTSTOFF-FILTER</p>  <p>H : 91 / 88 mm Ø : 79 / 76 mm ø : M14X1,5</p>	<p>SN 40705 FILTRE A GASOIL FUEL FILTER KRAFTSTOFF-FILTER</p>  <p>H : 182 mm Ø : 101.5 mm ø : X</p>
<p>SN 090 FILTRE A GASOIL FUEL FILTER KRAFTSTOFF-FILTER</p>  <p>H : 115 / 105 mm Ø : 59 mm ø : 13.5 / 13.5 mm</p>	<p>SN 327 FILTRE A GASOIL FUEL FILTER KRAFTSTOFF-FILTER</p>  <p>H : 157 / 139 mm Ø : 85 / 81 mm ø : M16X1,5</p>	<p>SN 40706 FILTRE A GASOIL FUEL FILTER KRAFTSTOFF-FILTER</p>  <p>H : 230 / 227 mm Ø : 120 mm ø : X</p>
<p>SN 1146 FILTRE A GASOIL FUEL FILTER KRAFTSTOFF-FILTER</p>  <p>H : 115 / 105 mm Ø : 65 mm ø : 13.5 / 13.5 mm</p>	<p>SN 40529 FILTRE A GASOIL FUEL FILTER KRAFTSTOFF-FILTER</p>  <p>H : 192 / 190 mm Ø : 94 / 94 mm ø : M20X1,5</p>	<p>SN 5019 FILTRE A GASOIL FUEL FILTER KRAFTSTOFF-FILTER</p>  <p>H : 202.5 / 200.5 mm Ø : 111 / 108 mm ø : 7/8"-14UNF</p>
<p>SN 1147 FILTRE A GASOIL FUEL FILTER KRAFTSTOFF-FILTER</p>  <p>H : 145 / 131 mm Ø : 85 mm ø : 13.5 / 13.5 mm</p>	<p>SN 40602 FILTRE A GASOIL FUEL FILTER KRAFTSTOFF-FILTER</p>  <p>H : 201 / 164 mm Ø : 94 / 94 mm ø : 1"-14UNF</p>	<p>SN 5038 FILTRE A GASOIL FUEL FILTER KRAFTSTOFF-FILTER</p>  <p>H : 161 / 142 mm Ø : 93 / 90 mm ø : 13/16"-18UN</p>
<p>SN 1251 FILTRE A GASOIL SEPARATEUR D'EAU FUEL WATER SEPARATOR FILTER ABSCHIEDER DIESELFILTER</p>  <p>H : 129 / 110 mm Ø : 77 / 77 mm ø : M16X1,5</p>	<p>SN 40606 FILTRE A GASOIL FUEL FILTER KRAFTSTOFF-FILTER</p>  <p>H : 176 / 175 mm Ø : 94 / 94 mm ø : 7/8"-14UNF</p>	<p>SN 5052 FILTRE A GASOIL FUEL FILTER KRAFTSTOFF-FILTER</p>  <p>H : 123 / 121 mm Ø : 78.5 / 77 mm ø : M16X1,5</p>
<p>SN 1276 FILTRE A GASOIL FUEL FILTER KRAFTSTOFF-FILTER</p>  <p>H : 173 / 155 mm Ø : 77 / 77 mm ø : M16X1,5 / X</p>	<p>SN 40650 FILTRE A GASOIL FUEL FILTER KRAFTSTOFF-FILTER</p>  <p>H : 180 / 173 mm Ø : 97 mm ø : 30 / 17 mm</p> <p>DINT=105 S=3 ET DINT=37 S=3,5</p>	<p>SN 5269 FILTRE A GASOIL FUEL FILTER KRAFTSTOFF-FILTER</p>  <p>H : 167 / 165 mm Ø : 109 / 108 mm ø : 7/8"-14UNF</p>





















KASSBOHRER	KASSBOHRER	KASSBOHRER
<p>SN 70141 FILTRE A GASOIL FUEL FILTER KRAFTSTOFF-FILTER</p> <p>H : 203 / 190 mm Ø : 94 / 94 mm ø : 45 / 13 mm</p> 	<p>SN 909110 FILTRE A GASOIL SEPARATEUR D'EAU FUEL WATER SEPARATOR FILTER ABSCHIEDER DIESELFILTER</p> <p>H : 161 / 159 mm Ø : 112 / 109 mm ø : 1"-14UNF / M95X2,5</p> <p>10µ_BOL/GLASS BOWL: Y RK30063</p> 	<p>SO 242 FILTRE A HUILE OIL FILTER OELFILTER</p> <p>H : 180 / 178 mm Ø : 97 / 95 mm ø : 3/4"-16UNF</p> 
<p>SN 70142 FILTRE A GASOIL FUEL FILTER KRAFTSTOFF-FILTER</p> <p>H : 155 / 144 mm Ø : 78 / 77 mm ø : M16X1,5 / M8X1,25</p> 	<p>SO 040 FILTRE A HUILE OIL FILTER OELFILTER</p> <p>H : 210 / 208 mm Ø : 95 / 94 mm ø : 1"-12UNF</p> 	<p>SO 3000 FILTRE A HUILE OIL FILTER OELFILTER</p> <p>H : 301 / 295 mm Ø : 119 mm ø : 2"1/4-12UNF</p> 
<p>SN 70146 FILTRE A GASOIL FUEL FILTER KRAFTSTOFF-FILTER</p> <p>H : 200 / 176 mm Ø : 89 / 81 mm ø : 9 mm</p> 	<p>SO 10011 FILTRE A HUILE OIL FILTER OELFILTER</p> <p>H : 300 / 294 mm Ø : 119 / 119 mm ø : 2"1/4-12UNF</p> 	<p>SO 3320 FILTRE A HUILE OIL FILTER OELFILTER</p> <p>H : 190 / 165 mm Ø : 121 mm ø : 56 / 14 mm</p> 
<p>SN 70154 FILTRE A GASOIL FUEL FILTER KRAFTSTOFF-FILTER</p> <p>H : 103 / 85 mm Ø : 92 mm ø : 44 / 28 mm</p> 	<p>SO 10046 FILTRE A HUILE OIL FILTER OELFILTER</p> <p>H : 176 / 173 mm Ø : 93 / 93 mm ø : 1"1/8-16UNF</p> 	<p>SO 3327 FILTRE A HUILE OIL FILTER OELFILTER</p> <p>H : 270 / 243 mm Ø : 120 mm ø : 56 / 14 mm</p> 
<p>SN 70160 FILTRE A GASOIL FUEL FILTER KRAFTSTOFF-FILTER</p> <p>H : 41 / 38 mm Ø : 50 / 47 mm ø : 40.5 / 27.5 mm</p> 	<p>SO 10056 FILTRE A HUILE OIL FILTER OELFILTER</p> <p>H : 263 / 260 mm Ø : 118 / 118 mm ø : M36X1,5</p> 	<p>SO 3345 FILTRE A HUILE OIL FILTER OELFILTER</p> <p>H : 140 / 138.5 mm Ø : 93.5 / 90 mm ø : 1"-16UNF</p> 
<p>SN 70238 FILTRE A GASOIL FUEL FILTER KRAFTSTOFF-FILTER</p> <p>H : 155 / 110 mm Ø : 85 / 79 mm</p> <p>5µ_BOL/GLASS BOWL :MO 3254</p> 	<p>SO 10067 FILTRE A HUILE OIL FILTER OELFILTER</p> <p>H : 141 / 139 mm Ø : 94 / 90 mm ø : M24X1,5</p> 	<p>SO 3349 FILTRE A HUILE OIL FILTER OELFILTER</p> <p>H : 180 / 178 mm Ø : 97 / 95 mm ø : 1"-16UNF</p> 

KASSBOHRER	KASSBOHRER	KASSBOHRER
<p>SO 3640 FILTRE A HUILE OIL FILTER OELFILTER</p> <p>H : 304 / 302.5 mm Ø : 137 / 135 mm ø : M36X1,5</p> 	<p>SO 7081 FILTRE A HUILE OIL FILTER OELFILTER</p> <p>H : 152 / 137 mm Ø : 83 mm ø : 39 / 8.5 mm</p> 	<p>WE 2076 FILTRE EAU MOTEUR COOLANT FILTER KÜHL FLÜSSIGKEITFILTER</p> <p>H : 142 / 141 mm Ø : 96 / 94.5 mm ø : 11/16"-16UN</p> 
<p>SO 4105 FILTRE A HUILE OIL FILTER OELFILTER</p> <p>H : 195 mm Ø : 116 mm ø : 56 / 56 mm</p> 	<p>SO 7082 FILTRE A HUILE OIL FILTER OELFILTER</p> <p>H : 213.5 / 197 mm Ø : 83 mm ø : 36.5 / 9.5 mm</p> <p>FLASQUE FERMEE AVEC TROU D4 POUR BP</p> 	<p>WE 2106 FILTRE EAU MOTEUR COOLANT FILTER KÜHL FLÜSSIGKEITFILTER</p> <p>H : 138 / 136 mm Ø : 94 / 93 mm ø : 11/16"-16UN</p> 
<p>SO 646 FILTRE A HUILE OIL FILTER OELFILTER</p> <p>H : 195 / 193 mm Ø : 92 / 89 mm ø : 25 / 12 mm</p> 	<p>SO 7139 FILTRE A HUILE OIL FILTER OELFILTER</p> <p>H : 265 / 251 mm Ø : 120 mm ø : 53 / 14 mm</p> 	<p>LEITNER</p> <p>SA 10920 FILTRE A AIR AIR FILTER LUFTFILTER</p> <p>H : 495 / 483 mm Ø : 308 / 242 mm ø : 131 / 10 mm</p> 
<p>SO 7001 FILTRE A HUILE OIL FILTER OELFILTER</p> <p>H : 200 / 195 mm Ø : 84 mm ø : 22 / 22 mm</p> 	<p>SO 734 FILTRE A HUILE OIL FILTER OELFILTER</p> <p>H : 203 / 201 mm Ø : 123 / 120 mm ø : 1"1/2-12UNF</p> 	<p>SA 14010 FILTRE A AIR AIR FILTER LUFTFILTER</p> <p>H : 495 / 485 mm Ø : 242 mm ø : 132 / 10.5 mm</p> 
<p>SO 7034 FILTRE A HUILE OIL FILTER OELFILTER</p> <p>H : 195 mm Ø : 77.5 mm ø : 23 / 23 mm</p> <p>JORING ØINT=90MM S=4MM</p> 	<p>TB 1390 FILTRE DESSICATEUR DESICCATOR FILTER TROCKNUNGS-FILTER</p> <p>H : 165 / 163 mm Ø : 139 / 137 mm ø : M39X1,5</p> <p>COALESCENTE/COALESCING/OELABSCHIEDER</p> 	<p>SA 14531 FILTRE A AIR AIR FILTER LUFTFILTER</p> <p>H : 326 / 280 mm Ø : 195 mm ø : 101 mm</p> 
<p>SO 7063 FILTRE A HUILE OIL FILTER OELFILTER</p> <p>H : 153 mm Ø : 64 mm ø : 25 / 25 mm</p> 	<p>WE 2069 FILTRE EAU MOTEUR COOLANT FILTER KÜHL FLÜSSIGKEITFILTER</p> <p>H : 137 / 135 mm Ø : 96 / 95 mm ø : 11/16"-16UN</p> 	<p>SA 19119 FILTRE A AIR AIR FILTER LUFTFILTER</p> <p>H : 210 mm Ø : 277 mm ø : 211 / 211 mm</p> 







































DAMEUSES | SNOW-GROOMING MACHINES | PISTENBULLY

<p>LEITNER</p> <p>SAD 085012</p> <p>FILTRE A AIR AIR FILTER LUFTFILTER</p> <p>H : 288 / 251 mm Ø : 196 mm ø : 106 mm</p> 	<p>LEITNER</p> <p>SH 74019</p> <p>FILTRE HYDRAULIQUE HYDRAULIC FILTER HYDRAULIKFILTER</p> <p>H : 203 / 184 mm Ø : 74 mm ø : 33.5 mm</p> 	<p>LEITNER</p> <p>SN 037</p> <p>FILTRE A GASOIL FUEL FILTER KRAFTSTOFF-FILTER</p> <p>H : 188 / 180 mm Ø : 94 mm ø : 26 / 14 mm</p> <p>FILTRE DÉMONTABLE</p> 
<p>SH 52049</p> <p>FILTRE HYDRAULIQUE HYDRAULIC FILTER HYDRAULIKFILTER</p> <p>H : 303 / 297 mm Ø : 59 mm ø : 27 mm</p> 	<p>SH 74052</p> <p>FILTRE HYDRAULIQUE HYDRAULIC FILTER HYDRAULIKFILTER</p> <p>H : 333 / 307 mm Ø : 114 mm ø : 67.5 mm</p> 	<p>SN 039</p> <p>FILTRE A GASOIL FUEL FILTER KRAFTSTOFF-FILTER</p> <p>H : 122 / 120 mm Ø : 81 / 78 mm ø : M16X1,5</p> 
<p>SH 52309</p> <p>FILTRE HYDRAULIQUE HYDRAULIC FILTER HYDRAULIKFILTER</p> <p>H : 333 / 329 mm Ø : 90 mm ø : 39.5 mm</p> 	<p>SH 75079</p> <p>FILTRE HYDRAULIQUE HYDRAULIC FILTER HYDRAULIKFILTER</p> <p>H : 94 / 90 mm Ø : 35 mm ø : 11 mm</p> 	<p>SN 70103</p> <p>FILTRE A GASOIL FUEL FILTER KRAFTSTOFF-FILTER</p> <p>H : 156 / 140 mm Ø : 81 / 79 mm ø : M16X1,5</p> 
<p>SH 52516</p> <p>FILTRE HYDRAULIQUE HYDRAULIC FILTER HYDRAULIKFILTER</p> <p>H : 104 / 100 mm Ø : 45 mm ø : 19.5 mm</p> 	<p>SH 77013</p> <p>FILTRE HYDRAULIQUE HYDRAULIC FILTER HYDRAULIKFILTER</p> <p>H : 150 / 126 mm Ø : 150 mm ø : 2"-BSP</p> 	<p>SN 70142</p> <p>FILTRE A GASOIL FUEL FILTER KRAFTSTOFF-FILTER</p> <p>H : 155 / 144 mm Ø : 78 / 77 mm ø : M16X1,5 / M8X1,25</p> 
<p>SH 63161</p> <p>FILTRE HYDRAULIQUE HYDRAULIC FILTER HYDRAULIKFILTER</p> <p>H : 177 / 175 mm Ø : 128 / 127 mm ø : 1"1/4-BSP</p> 	<p>SN 001</p> <p>FILTRE A GASOIL FUEL FILTER KRAFTSTOFF-FILTER</p> <p>H : 72 mm Ø : 87 / 84 mm ø : 19 mm</p> 	<p>SO 008</p> <p>FILTRE A HUILE OIL FILTER OELFILTER</p> <p>H : 111 / 108 mm Ø : 110 / 108 mm ø : 3/4"-16UNF</p> 
<p>SH 74004</p> <p>FILTRE HYDRAULIQUE HYDRAULIC FILTER HYDRAULIKFILTER</p> <p>H : 144 / 126 mm Ø : 60 mm ø : 32 mm</p> 	<p>SN 017</p> <p>FILTRE A GASOIL FUEL FILTER KRAFTSTOFF-FILTER</p> <p>H : 178 / 177 mm Ø : 110 / 108 mm ø : 3/4"-16UNF</p> 	<p>SO 040</p> <p>FILTRE A HUILE OIL FILTER OELFILTER</p> <p>H : 210 / 208 mm Ø : 95 / 94 mm ø : 1"-12UNF</p> 

LEITNER	MEILI-V	MEILI-V
<p>SO 053 FILTRE A HUILE OIL FILTER OELFILTER</p> <p>H : 144 / 142 mm Ø : 93 / 91 mm ø : 3/4"-16UNF</p> 	<p>SA 10716 FILTRE A AIR AIR FILTER LUFTFILTER</p> <p>H : 295 / 271 mm Ø : 158 / 126 mm ø : 65 / 8.5 mm</p> 	<p>SH 63203 FILTRE HYDRAULIQUE HYDRAULIC FILTER HYDRAULIKFILTER</p> <p>H : 229 / 227 mm Ø : 131 / 129 mm ø : 1"1/4-BSP</p> 
<p>SO 287 FILTRE A HUILE OIL FILTER OELFILTER</p> <p>H : 178 / 176 mm Ø : 111 / 109 mm ø : 3/4"-16UNF</p> 	<p>SA 14008 FILTRE A AIR AIR FILTER LUFTFILTER</p> <p>H : 351 / 339 mm Ø : 164 mm ø : 86 / 8.5 mm</p> 	<p>SN 327 FILTRE A GASOIL FUEL FILTER KRAFTSTOFF-FILTER</p> <p>H : 157 / 139 mm Ø : 85 / 81 mm ø : M16X1,5</p> 
<p>SO 3327 FILTRE A HUILE OIL FILTER OELFILTER</p> <p>H : 270 / 243 mm Ø : 120 mm ø : 56 / 14 mm</p> 	<p>SA 14017 FILTRE A AIR AIR FILTER LUFTFILTER</p> <p>H : 296 / 285 mm Ø : 126 mm ø : 64 / 8.5 mm</p> 	<p>SN 565 FILTRE A GASOIL FUEL FILTER KRAFTSTOFF-FILTER</p> <p>H : 110 mm Ø : 87 / 84 mm ø : 19 mm</p> <p>JORING DINT=14 S=2,5MM DINT=6 S=1,5MM</p> 
<p>SO 416 FILTRE A HUILE OIL FILTER OELFILTER</p> <p>H : 142 / 140 mm Ø : 109 / 107.5 mm ø : 3/4"-16UNF</p> 	<p>SA 14085 FILTRE A AIR AIR FILTER LUFTFILTER</p> <p>H : 336 / 322 mm Ø : 150 mm ø : 71 / 9 mm</p> 	<p>SO 242 FILTRE A HUILE OIL FILTER OELFILTER</p> <p>H : 180 / 178 mm Ø : 97 / 95 mm ø : 3/4"-16UNF</p> 
<p>SO 417 FILTRE A HUILE OIL FILTER OELFILTER</p> <p>H : 212 / 210 mm Ø : 110 / 109 mm ø : M30X2</p> 	<p>SA 14472 FILTRE A AIR AIR FILTER LUFTFILTER</p> <p>H : 327 mm Ø : 79 / 70 mm ø : 63 / 16.5 mm</p> 	<p>SO 404 FILTRE A HUILE OIL FILTER OELFILTER</p> <p>H : 144 / 141 mm Ø : 94 / 91 mm ø : 3/4"-16UNF</p> 
<p>WE 2069 FILTRE EAU MOTEUR COOLANT FILTER KÜHL FLÜSSIGKEITFILTER</p> <p>H : 137 / 135 mm Ø : 96 / 95 mm ø : 11/16"-16UN</p> 	<p>SH 63161 FILTRE HYDRAULIQUE HYDRAULIC FILTER HYDRAULIKFILTER</p> <p>H : 177 / 175 mm Ø : 128 / 127 mm ø : 1"1/4-BSP</p> 	<p>PAANA</p> <p>SA 16229 FILTRE A AIR AIR FILTER LUFTFILTER</p> <p>H : 396 / 388 mm Ø : 185 mm ø : 107 mm</p> 







































<p>PAANA</p> <p>SH 56775</p> <p>FILTRE HYDRAULIQUE HYDRAULIC FILTER HYDRAULIKFILTER</p>  <p>H : 169 mm Ø : 129 / 127 mm ø : 1"1/2-16UNF</p>	<p>PRINOTH</p> <p>KN 70416</p> <p>KIT FILTRE A GASOIL FUEL FILTER KRAFTSTOFF-FILTER</p>  <p>H : 239 / 205 mm Ø : 117 mm</p> <p>1 TUBE GRAISSE + NOTICE</p>	<p>PRINOTH</p> <p>SA 14580</p> <p>FILTRE A AIR AIR FILTER LUFTFILTER</p>  <p>H : 378 / 365 mm Ø : 302 mm ø : 191 / 10.3 mm</p>
<p>SN 40529</p> <p>FILTRE A GASOIL FUEL FILTER KRAFTSTOFF-FILTER</p>  <p>H : 192 / 190 mm Ø : 94 / 94 mm ø : M20X1,5</p>	<p>MO 7001</p> <p>PREFILTRE PREFILTER VORFILTER</p>  <p>H : 80 mm Ø : 59 / 56 / 54 mm ø : 48 / 17 mm</p> <p>MERCEDES A 4700901251</p>	<p>SA 16359</p> <p>FILTRE A AIR AIR FILTER LUFTFILTER</p>  <p>H : 500 / 487 mm Ø : 292 / 262 mm ø : 167 / 17 mm</p>
<p>SN 40602</p> <p>FILTRE A GASOIL FUEL FILTER KRAFTSTOFF-FILTER</p>  <p>H : 201 / 164 mm Ø : 94 / 94 mm ø : 1"-14UNF</p>	<p>RT 6</p> <p>FILTRE A CARBURANT FUEL FILTER TREIBSTOFF-FILTER</p>  <p>H : 193 / 125 mm Ø : 50 / 42 mm ø : 11 / 9 mm</p>	<p>SA 16472</p> <p>FILTRE A AIR AIR FILTER LUFTFILTER</p>  <p>H : 187 mm Ø : 331 / 205 mm</p>
<p>SO 10046</p> <p>FILTRE A HUILE OIL FILTER OELFILTER</p>  <p>H : 176 / 173 mm Ø : 93 / 93 mm ø : 1"1/8-16UNF</p>	<p>SA 10384 K</p> <p>FILTRE A AIR AIR FILTER LUFTFILTER</p>  <p>H : 419 / 409 mm Ø : 258 / 201 mm ø : 135 / 17 mm</p>	<p>SA 16508</p> <p>FILTRE A AIR AIR FILTER LUFTFILTER</p>  <p>H : 60 / 40 mm Ø : 330 / 303 mm</p>
<p>PRINOTH</p> <p>KD 70322</p> <p>KIT FILTRE A UREE UREA FILTER KIT HARNSTOFFFILTER-KIT</p>  <p>H : 99 / 82 mm Ø : 72 / 59 mm</p>	<p>SA 11683 K</p> <p>FILTRE A AIR AIR FILTER LUFTFILTER</p>  <p>H : 393 / 383 mm Ø : 199 / 155 mm ø : 88 / 19 mm</p>	<p>SA 16776</p> <p>FILTRE A AIR AIR FILTER LUFTFILTER</p>  <p>H : 590 mm L : 362 mm l : 182 mm Ø : 150 / 149 mm</p>
<p>KD 70436</p> <p>KIT FILTRE A UREE UREA FILTER KIT HARNSTOFFFILTER-KIT</p>  <p>H : 102 mm Ø : 75 mm ø : X</p> <p>MEDIA ARME NYLON</p>	<p>SA 14010</p> <p>FILTRE A AIR AIR FILTER LUFTFILTER</p>  <p>H : 495 / 485 mm Ø : 242 mm ø : 132 / 10.5 mm</p>	<p>SA 16777</p> <p>FILTRE A AIR AIR FILTER LUFTFILTER</p>  <p>H : 543 mm Ø : 150 / 127 mm</p>

PRINOTH	PRINOTH	PRINOTH
<p>SA 17278</p> <p>FILTRE A AIR AIR FILTER LUFTFILTER</p> <p>H : 480 / 438 mm Ø : 265 mm ø : 170 mm</p> 	<p>SAO 5119</p> <p>FILTRE AERATION MOTEUR ENGINE BREATHER FILTER MOTORENTLÜFTUNG FILTER</p> <p>H : 120 / 111 mm Ø : 64 / 56 mm ø : 41 mm</p> 	<p>SH 52309</p> <p>FILTRE HYDRAULIQUE HYDRAULIC FILTER HYDRAULIKFILTER</p> <p>H : 333 / 329 mm Ø : 90 mm ø : 39.5 mm</p> 
<p>SA 17281</p> <p>FILTRE A AIR AIR FILTER LUFTFILTER</p> <p>H : 365 / 325 mm Ø : 247 mm ø : 150 mm</p> 	<p>SAO 5351</p> <p>FILTRE AERATION MOTEUR ENGINE BREATHER FILTER MOTORENTLÜFTUNG FILTER</p> <p>H : 127.5 / 125 mm Ø : 104 mm ø : 32 mm</p> 	<p>SH 52516</p> <p>FILTRE HYDRAULIQUE HYDRAULIC FILTER HYDRAULIKFILTER</p> <p>H : 104 / 100 mm Ø : 45 mm ø : 19.5 mm</p> 
<p>SA 17446</p> <p>FILTRE A AIR AIR FILTER LUFTFILTER</p> <p>H : 426 mm Ø : 268 mm ø : 172 mm</p> 	<p>SH 52007</p> <p>FILTRE HYDRAULIQUE HYDRAULIC FILTER HYDRAULIKFILTER</p> <p>H : 170 / 165 mm Ø : 55.5 mm ø : 26.5 mm</p> 	<p>SH 52933</p> <p>FILTRE HYDRAULIQUE HYDRAULIC FILTER HYDRAULIKFILTER</p> <p>H : 328 mm Ø : 89 mm ø : 50 / 50 mm</p> 
<p>SA 19415</p> <p>FILTRE A AIR AIR FILTER LUFTFILTER</p> <p>H : 387 / 378 mm Ø : 171 / 142 mm ø : 75 / 14 mm</p> 	<p>SH 52131</p> <p>FILTRE HYDRAULIQUE HYDRAULIC FILTER HYDRAULIKFILTER</p> <p>H : 398 / 393 mm Ø : 90 mm ø : 39.5 mm</p> 	<p>SH 56771</p> <p>FILTRE HYDRAULIQUE HYDRAULIC FILTER HYDRAULIKFILTER</p> <p>H : 272 mm Ø : 128 / 128 mm ø : 1"1/2-16UNF</p> 
<p>SA 19416</p> <p>FILTRE A AIR AIR FILTER LUFTFILTER</p> <p>H : 341 / 332 mm Ø : 232 mm ø : 124 / 16 mm</p> 	<p>SH 52278</p> <p>FILTRE HYDRAULIQUE HYDRAULIC FILTER HYDRAULIKFILTER</p> <p>H : 380 / 348 mm Ø : 106 / 90 mm</p> 	<p>SH 56775</p> <p>FILTRE HYDRAULIQUE HYDRAULIC FILTER HYDRAULIKFILTER</p> <p>H : 169 mm Ø : 129 / 127 mm ø : 1"1/2-16UNF</p> 
<p>SA 19417</p> <p>FILTRE A AIR AIR FILTER LUFTFILTER</p> <p>H : 396 / 385 mm Ø : 210 / 172 mm ø : 99 / 14 mm</p> 	<p>SH 52291</p> <p>FILTRE HYDRAULIQUE HYDRAULIC FILTER HYDRAULIKFILTER</p> <p>H : 445 / 411 mm Ø : 106 / 90 mm</p> 	<p>SH 63071</p> <p>FILTRE HYDRAULIQUE HYDRAULIC FILTER HYDRAULIKFILTER</p> <p>H : 306 / 230 mm Ø : 60 mm ø : 51 / 40 mm</p> 



DAMEUSES | SNOW-GROOMING MACHINES | PISTENBULLY



















<p>PRINOTH</p> <p>SH 63201</p> <p>FILTRE HYDRAULIQUE HYDRAULIC FILTER HYDRAULIKFILTER</p> <p>H : 228 / 226 mm Ø : 128 / 127 mm ø : 1"1/4-BSP</p> 	<p>PRINOTH</p> <p>SH 74193</p> <p>FILTRE HYDRAULIQUE HYDRAULIC FILTER HYDRAULIKFILTER</p> <p>H : 296 / 282 mm Ø : 60 mm ø : 33 mm</p> 	<p>PRINOTH</p> <p>SH 75030</p> <p>FILTRE HYDRAULIQUE HYDRAULIC FILTER HYDRAULIKFILTER</p> <p>H : 116 / 112 mm Ø : 69 mm ø : 33 mm</p> 
<p>SH 63612</p> <p>FILTRE HYDRAULIQUE HYDRAULIC FILTER HYDRAULIKFILTER</p> <p>H : 117 mm Ø : 29 mm ø : 15 mm</p> 	<p>SH 74373</p> <p>FILTRE HYDRAULIQUE HYDRAULIC FILTER HYDRAULIKFILTER</p> <p>H : 71 mm Ø : 110 mm ø : 40 mm</p> 	<p>SH 75046</p> <p>FILTRE HYDRAULIQUE HYDRAULIC FILTER HYDRAULIKFILTER</p> <p>H : 164 / 160 mm Ø : 90 mm ø : 47 mm</p> 
<p>SH 70501</p> <p>FILTRE HYDRAULIQUE HYDRAULIC FILTER HYDRAULIKFILTER</p> <p>H : 114 mm Ø : 144 mm ø : 38 mm</p> 	<p>SH 74400 SPV</p> <p>FILTRE HYDRAULIQUE HYDRAULIC FILTER HYDRAULIKFILTER</p> <p>H : 394 mm Ø : 88 mm ø : 39.5 / 39.5 mm</p> 	<p>SH 75062</p> <p>FILTRE HYDRAULIQUE HYDRAULIC FILTER HYDRAULIKFILTER</p> <p>H : 330 / 325 mm Ø : 90 mm ø : 47 mm</p> 
<p>SH 74156 SP</p> <p>FILTRE HYDRAULIQUE HYDRAULIC FILTER HYDRAULIKFILTER</p> <p>H : 318 / 301 mm Ø : 114 mm ø : 67 / 67 mm</p> 	<p>SH 74518</p> <p>FILTRE HYDRAULIQUE HYDRAULIC FILTER HYDRAULIKFILTER</p> <p>H : 219 / 213 mm Ø : 68 / 63 mm ø : 27.5 mm</p> 	<p>SH 75079</p> <p>FILTRE HYDRAULIQUE HYDRAULIC FILTER HYDRAULIKFILTER</p> <p>H : 94 / 90 mm Ø : 35 mm ø : 11 mm</p> 
<p>SH 74186 SP</p> <p>FILTRE HYDRAULIQUE HYDRAULIC FILTER HYDRAULIKFILTER</p> <p>H : 392 mm Ø : 88 mm ø : 39 / 39 mm</p> 	<p>SH 75004 V</p> <p>FILTRE HYDRAULIQUE HYDRAULIC FILTER HYDRAULIKFILTER</p> <p>H : 84 / 79 mm Ø : 47 mm ø : 20.5 mm</p> 	<p>SH 75160</p> <p>FILTRE HYDRAULIQUE HYDRAULIC FILTER HYDRAULIKFILTER</p> <p>H : 116 / 113 mm Ø : 56 mm ø : 24.5 mm</p> 
<p>SH 74187 SP</p> <p>FILTRE HYDRAULIQUE HYDRAULIC FILTER HYDRAULIKFILTER</p> <p>H : 329 mm Ø : 88 mm ø : 39 / 39 mm</p> 	<p>SH 75014</p> <p>FILTRE HYDRAULIQUE HYDRAULIC FILTER HYDRAULIKFILTER</p> <p>H : 153 / 149 mm Ø : 47 mm ø : 20.5 mm</p> 	<p>SH 75212 V</p> <p>FILTRE HYDRAULIQUE HYDRAULIC FILTER HYDRAULIKFILTER</p> <p>H : 210 / 203 mm Ø : 57 mm ø : 24.5 mm</p> 

<p>PRINOTH</p> <p>SH 75353</p> <p>FILTRE HYDRAULIQUE HYDRAULIC FILTER HYDRAULIKFILTER</p> <p>H : 169 / 165 mm Ø : 57 mm ø : X</p> 	<p>PRINOTH</p> <p>SN 40679</p> <p>FILTRE A GASOIL FUEL FILTER KRAFTSTOFF-FILTER</p> <p>H : 227 mm Ø : 81 / 67 mm</p> 	<p>PRINOTH</p> <p>SN 70141</p> <p>FILTRE A GASOIL FUEL FILTER KRAFTSTOFF-FILTER</p> <p>H : 203 / 190 mm Ø : 94 / 94 mm ø : 45 / 13 mm</p> 
<p>SN 039</p> <p>FILTRE A GASOIL FUEL FILTER KRAFTSTOFF-FILTER</p> <p>H : 122 / 120 mm Ø : 81 / 78 mm ø : M16X1,5</p> 	<p>SN 5074</p> <p>FILTRE A GASOIL FUEL FILTER KRAFTSTOFF-FILTER</p> <p>H : 123 / 120 mm Ø : 78 / 76 mm ø : M16X1,5</p> 	<p>SN 70142</p> <p>FILTRE A GASOIL FUEL FILTER KRAFTSTOFF-FILTER</p> <p>H : 155 / 144 mm Ø : 78 / 77 mm ø : M16X1,5 / M8X1,25</p> 
<p>SN 090</p> <p>FILTRE A GASOIL FUEL FILTER KRAFTSTOFF-FILTER</p> <p>H : 115 / 105 mm Ø : 59 mm ø : 13.5 / 13.5 mm</p> 	<p>SN 5297</p> <p>FILTRE A GASOIL FUEL FILTER KRAFTSTOFF-FILTER</p> <p>H : 143 / 141 mm Ø : 97 / 94 mm ø : M24X1,5</p> 	<p>SN 70154</p> <p>FILTRE A GASOIL FUEL FILTER KRAFTSTOFF-FILTER</p> <p>H : 103 / 85 mm Ø : 92 mm ø : 44 / 28 mm</p> 
<p>SN 327</p> <p>FILTRE A GASOIL FUEL FILTER KRAFTSTOFF-FILTER</p> <p>H : 157 / 139 mm Ø : 85 / 81 mm ø : M16X1,5</p> 	<p>SN 55418</p> <p>FILTRE A GASOIL FUEL FILTER KRAFTSTOFF-FILTER</p> <p>H : 236 / 235 mm Ø : 94 mm ø : 1"-14UNF</p> 	<p>SN 70160</p> <p>FILTRE A GASOIL FUEL FILTER KRAFTSTOFF-FILTER</p> <p>H : 41 / 38 mm Ø : 50 / 47 mm ø : 40.5 / 27.5 mm</p> 
<p>SN 40514</p> <p>FILTRE A GASOIL FUEL FILTER KRAFTSTOFF-FILTER</p> <p>H : 240 mm Ø : 94 / 94 mm ø : 1"-14UNF / M14X2</p> 	<p>SN 55429</p> <p>FILTRE A GASOIL FUEL FILTER KRAFTSTOFF-FILTER</p> <p>H : 272 mm Ø : 94 mm ø : 1"-14UNF</p> 	<p>SN 70186</p> <p>FILTRE A GASOIL FUEL FILTER KRAFTSTOFF-FILTER</p> <p>H : 230 / 208 mm Ø : 78 mm ø : 26.5 / 11 mm</p> 
<p>SN 40678</p> <p>FILTRE A GASOIL FUEL FILTER KRAFTSTOFF-FILTER</p> <p>H : 155 / 147 mm Ø : 82 / 69 mm ø : X</p> 	<p>SN 55438</p> <p>FILTRE A GASOIL SEPARATEUR D'EAU FUEL WATER SEPARATOR FILTER ABSCHIEDER DIESELFILTER</p> <p>H : 231 mm Ø : 108 / 107 mm ø : 1"-14UNF / 3"-4UNF</p> 	<p>SN 70283</p> <p>FILTRE A GASOIL FUEL FILTER KRAFTSTOFF-FILTER</p> <p>H : 41 / 38 mm Ø : 50 / 47 mm ø : 40.5 / 27.5 mm</p> 





















<p>PRINOTH</p> <p>SN 70399</p> <p>FILTRE A GASOIL FUEL FILTER KRAFTSTOFF-FILTER</p> <p>H : 238 mm Ø : 116 mm</p> 	<p>PRINOTH</p> <p>SO 242</p> <p>FILTRE A HUILE OIL FILTER OELFILTER</p> <p>H : 180 / 178 mm Ø : 97 / 95 mm ø : 3/4"-16UNF</p> 	<p>PRINOTH</p> <p>SO 7055</p> <p>FILTRE A HUILE OIL FILTER OELFILTER</p> <p>H : 312 / 298 mm Ø : 120 mm ø : 54 mm</p> 
<p>SN 70421</p> <p>FILTRE A GASOIL SEPARATEUR D'EAU FUEL WATER SEPARATOR FILTER ABSCHIEDER DIESELFILTER</p> <p>H : 231 mm Ø : 111 mm ø : 1"-14UNF / M80X3</p> 	<p>SO 3327</p> <p>FILTRE A HUILE OIL FILTER OELFILTER</p> <p>H : 270 / 243 mm Ø : 120 mm ø : 56 / 14 mm</p> 	<p>SO 7081</p> <p>FILTRE A HUILE OIL FILTER OELFILTER</p> <p>H : 152 / 137 mm Ø : 83 mm ø : 39 / 8.5 mm</p> 
<p>SN 909030</p> <p>FILTRE A GASOIL SEPARATEUR D'EAU FUEL WATER SEPARATOR FILTER ABSCHIEDER DIESELFILTER</p> <p>H : 158 / 143.5 mm Ø : 111 / 108 mm ø : 1"-14UNF / M95X2,5</p> <p>30µ_BOL/GLASS BOWL: MO 3916</p> 	<p>SO 3376</p> <p>FILTRE A HUILE OIL FILTER OELFILTER</p> <p>H : 97 / 95 mm Ø : 95 / 93 mm ø : 3/4"-16UNF</p> 	<p>SO 7139</p> <p>FILTRE A HUILE OIL FILTER OELFILTER</p> <p>H : 265 / 251 mm Ø : 120 mm ø : 53 / 14 mm</p> 
<p>SN 916010</p> <p>FILTRE A GASOIL SEPARATEUR D'EAU FUEL WATER SEPARATOR FILTER ABSCHIEDER DIESELFILTER</p> <p>H : 217 / 215 mm Ø : 112 / 109 mm ø : 1"-14UNF / M95X2,5</p> <p>10µ_BOL/GLASS BOWL: Y RK30063</p> 	<p>SO 3730</p> <p>FILTRE A HUILE OIL FILTER OELFILTER</p> <p>H : 260 / 258 mm Ø : 110 / 108 mm ø : 1"1/8-16UNF</p> 	<p>SO 7238</p> <p>FILTRE A HUILE OIL FILTER OELFILTER</p> <p>H : 265 / 263 mm Ø : 120 mm ø : 57 / 45 mm</p> 
<p>SO 040</p> <p>FILTRE A HUILE OIL FILTER OELFILTER</p> <p>H : 210 / 208 mm Ø : 95 / 94 mm ø : 1"-12UNF</p> 	<p>SO 515</p> <p>FILTRE A HUILE OIL FILTER OELFILTER</p> <p>H : 263 / 261 mm Ø : 111 / 108 mm ø : 1"1/8-16UNF</p> 	<p>SO 7266</p> <p>FILTRE A HUILE OIL FILTER OELFILTER</p> <p>H : 154 / 138 mm Ø : 89 mm ø : 43 / 15 mm</p> 
<p>SO 10052</p> <p>FILTRE A HUILE OIL FILTER OELFILTER</p> <p>H : 308 / 305 mm Ø : 138 / 136 mm ø : 1"1/2-16UNF</p> 	<p>SO 7001</p> <p>FILTRE A HUILE OIL FILTER OELFILTER</p> <p>H : 200 / 195 mm Ø : 84 mm ø : 22 / 22 mm</p> 	<p>TB 1390</p> <p>FILTRE DESSICATEUR DESICCATOR FILTER TROCKNUNGS-FILTER</p> <p>H : 165 / 163 mm Ø : 139 / 137 mm ø : M39X1,5</p> <p>COALESCENTE/COALESCING/OELABSCHIEDER</p> 

DAMEUSES | SNOW-GROOMING MACHINES | PISTENBULLY

<p>PRINOTH</p> <p>TCO 503 BOUCHON DE RESERVOIR TANK CAP TANKDECKEL</p> <p>H : 180 / 62 mm Ø : 92 / 44 mm</p> 	<p>RATRAC</p> <p>SH 64184 FILTRE HYDRAULIQUE HYDRAULIC FILTER HYDRAULIKFILTER</p> <p>H : 86 / 83 mm Ø : 42 mm ø : 22 mm</p> 	<p>RATRAC</p> <p>SN 5019 FILTRE A GASOIL FUEL FILTER KRAFTSTOFF-FILTER</p> <p>H : 202.5 / 200.5 mm Ø : 111 / 108 mm ø : 7/8"-14UNF</p> 
<p>TCO 508 BOUCHON DE RESERVOIR TANK CAP TANKDECKEL</p> <p>H : 39 mm</p> 	<p>SH 64527 FILTRE HYDRAULIQUE HYDRAULIC FILTER HYDRAULIKFILTER</p> <p>H : 189 mm Ø : 102 mm ø : 52 / M6X1</p> 	<p>SN 5020 FILTRE A GASOIL FUEL FILTER KRAFTSTOFF-FILTER</p> <p>H : 202 / 200 mm Ø : 94 / 94 mm ø : 1"-14UNF</p> 
<p>WE 2142 FILTRE EAU MOTEUR COOLANT FILTER KÜHL FLÜSSIGKEITFILTER</p> <p>H : 102 / 99 mm Ø : 96 / 95 mm ø : 11/16"-16UN</p> 	<p>SH 64753 FILTRE HYDRAULIQUE HYDRAULIC FILTER HYDRAULIKFILTER</p> <p>H : 188 mm Ø : 102 mm ø : 61 / M6X1</p> 	<p>SO 3328 FILTRE A HUILE OIL FILTER OELFILTER</p> <p>H : 169 / 167 mm Ø : 112 / 108 mm ø : 1 1/8"-16UNF</p> 
<p>RATRAC</p> <p>SA 11770 FILTRE A AIR AIR FILTER LUFFTFILTER</p> <p>H : 241 / 229 mm Ø : 263.5 mm ø : 149 mm</p> 	<p>SN 1205 FILTRE A GASOIL FUEL FILTER KRAFTSTOFF-FILTER</p> <p>H : 83 / 80 mm Ø : 126 / 114 mm ø : 94 / 47 mm</p> 	<p>SO 517 FILTRE A HUILE OIL FILTER OELFILTER</p> <p>H : 149 / 147 mm Ø : 109 / 108 mm ø : 1"-16UNF</p> 
<p>SH 56760 FILTRE HYDRAULIQUE HYDRAULIC FILTER HYDRAULIKFILTER</p> <p>H : 169 mm Ø : 128.5 / 124 mm ø : 1 1/2"-16UNF</p> <p>1 JTPLAT EPAULE=114</p> 	<p>SN 185 FILTRE A GASOIL FUEL FILTER KRAFTSTOFF-FILTER</p> <p>H : 178 / 174 mm Ø : 97 / 94 mm ø : 1"-14UNF</p> 	<p>SO 667 FILTRE A HUILE OIL FILTER OELFILTER</p> <p>H : 264 / 262 mm Ø : 109 / 108 mm ø : 1 1/8"-16UNF</p> 
<p>SH 63161 FILTRE HYDRAULIQUE HYDRAULIC FILTER HYDRAULIKFILTER</p> <p>H : 177 / 175 mm Ø : 128 / 127 mm ø : 1 1/4"-BSP</p> 	<p>SN 194 FILTRE A GASOIL FUEL FILTER KRAFTSTOFF-FILTER</p> <p>H : 197 / 179 mm Ø : 95 / 93 mm ø : 1"-14UNF</p> 	<p>SO 691 FILTRE A HUILE OIL FILTER OELFILTER</p> <p>H : 308 / 306 mm Ø : 139 / 135 mm ø : 1 1/2"-16UNF</p> 



DAMEUSES | SNOW-GROOMING MACHINES | PISTENBULLY

<p>ROLBA</p> <p>SA 10300 K</p> <p>FILTRE A AIR AIR FILTER LUFTFILTER</p> <p>H : 269 / 259 mm Ø : 248 / 198 mm ø : 90 / 12 mm</p> 	<p>ROLBA</p> <p>SH 56760</p> <p>FILTRE HYDRAULIQUE HYDRAULIC FILTER HYDRAULIKFILTER</p> <p>H : 169 mm Ø : 128.5 / 124 mm ø : 1"1/2-16UNF</p> <p>1 JTPLAT EPAULE=114</p> 	<p>ROLBA</p> <p>SN 1205</p> <p>FILTRE A GASOIL FUEL FILTER KRAFTSTOFF-FILTER</p> <p>H : 83 / 80 mm Ø : 126 / 114 mm ø : 94 / 47 mm</p> 
<p>SA 11770</p> <p>FILTRE A AIR AIR FILTER LUFTFILTER</p> <p>H : 241 / 229 mm Ø : 263.5 mm ø : 149 mm</p> 	<p>SH 63161</p> <p>FILTRE HYDRAULIQUE HYDRAULIC FILTER HYDRAULIKFILTER</p> <p>H : 177 / 175 mm Ø : 128 / 127 mm ø : 1"1/4-BSP</p> 	<p>SN 185</p> <p>FILTRE A GASOIL FUEL FILTER KRAFTSTOFF-FILTER</p> <p>H : 178 / 174 mm Ø : 97 / 94 mm ø : 1"-14UNF</p> 
<p>SA 16554</p> <p>FILTRE A AIR AIR FILTER LUFTFILTER</p> <p>H : 416 / 405 mm Ø : 276 / 246 / 197 mm ø : 135 / 7/16"-20UNF</p> 	<p>SH 64184</p> <p>FILTRE HYDRAULIQUE HYDRAULIC FILTER HYDRAULIKFILTER</p> <p>H : 86 / 83 mm Ø : 42 mm ø : 22 mm</p> 	<p>SN 268</p> <p>FILTRE A GASOIL FUEL FILTER KRAFTSTOFF-FILTER</p> <p>H : 91 / 88 mm Ø : 79 / 76 mm ø : M14X1,5</p> 
<p>SH 52278</p> <p>FILTRE HYDRAULIQUE HYDRAULIC FILTER HYDRAULIKFILTER</p> <p>H : 380 / 348 mm Ø : 106 / 90 mm</p> 	<p>SH 64527</p> <p>FILTRE HYDRAULIQUE HYDRAULIC FILTER HYDRAULIKFILTER</p> <p>H : 189 mm Ø : 102 mm ø : 52 / M6X1</p> 	<p>SN 327</p> <p>FILTRE A GASOIL FUEL FILTER KRAFTSTOFF-FILTER</p> <p>H : 157 / 139 mm Ø : 85 / 81 mm ø : M16X1,5</p> 
<p>SH 52301</p> <p>FILTRE HYDRAULIQUE HYDRAULIC FILTER HYDRAULIKFILTER</p> <p>H : 228.5 mm Ø : 83 mm ø : 50 / 50 mm</p> 	<p>SH 64753</p> <p>FILTRE HYDRAULIQUE HYDRAULIC FILTER HYDRAULIKFILTER</p> <p>H : 188 mm Ø : 102 mm ø : 61 / M6X1</p> 	<p>SN 5019</p> <p>FILTRE A GASOIL FUEL FILTER KRAFTSTOFF-FILTER</p> <p>H : 202.5 / 200.5 mm Ø : 111 / 108 mm ø : 7/8"-14UNF</p> 
<p>SH 52309</p> <p>FILTRE HYDRAULIQUE HYDRAULIC FILTER HYDRAULIKFILTER</p> <p>H : 333 / 329 mm Ø : 90 mm ø : 39.5 mm</p> 	<p>SN 039</p> <p>FILTRE A GASOIL FUEL FILTER KRAFTSTOFF-FILTER</p> <p>H : 122 / 120 mm Ø : 81 / 78 mm ø : M16X1,5</p> 	<p>SO 180</p> <p>FILTRE A HUILE OIL FILTER OELFILTER</p> <p>H : 265 / 262 mm Ø : 111 / 109 mm ø : 1"1/8-16UNF</p> 

ROLBA

SO 242

FILTRE A HUILE
OIL FILTER
OELFILTER

H : 180 / 178 mm
Ø : 97 / 95 mm
ø : 3/4"-16UNF



SHANTUI

SO 10011

FILTRE A HUILE
OIL FILTER
OELFILTER

H : 300 / 294 mm
Ø : 119 / 119 mm
ø : 2 1/4"-12UNF



SO 3328

FILTRE A HUILE
OIL FILTER
OELFILTER

H : 169 / 167 mm
Ø : 112 / 108 mm
ø : 1 1/8"-16UNF



SO 3345

FILTRE A HUILE
OIL FILTER
OELFILTER

H : 140 / 138.5 mm
Ø : 93.5 / 90 mm
ø : 1"-16UNF



SHANTUI

SN 1212

FILTRE A GASOIL
FUEL FILTER
KRAFTSTOFF-FILTER

H : 191 / 172 mm
Ø : 94 / 94 mm
ø : 1"-14UNF



SO 667

FILTRE A HUILE
OIL FILTER
OELFILTER

H : 264 / 262 mm
Ø : 109 / 108 mm
ø : 1 1/8"-16UNF



SN 1251

FILTRE A GASOIL SEPARATEUR
D'EAU
FUEL WATER SEPARATOR FILTER
ABSCHIEDER DIESELFILTER

H : 129 / 110 mm
Ø : 77 / 77 mm
ø : M16X1,5



STAHL PIST.FAHRZEUGE

SN 4070

FILTRE A GASOIL
FUEL FILTER
KRAFTSTOFF-FILTER

H : 210 / 209 mm
Ø : 94 / 92 mm
ø : M16X1,5



SN 5038

FILTRE A GASOIL
FUEL FILTER
KRAFTSTOFF-FILTER

H : 161 / 142 mm
Ø : 93 / 90 mm
ø : 13/16"-18UN



SO 040

FILTRE A HUILE
OIL FILTER
OELFILTER

H : 210 / 208 mm
Ø : 95 / 94 mm
ø : 1"-12UNF



SN 5052

FILTRE A GASOIL
FUEL FILTER
KRAFTSTOFF-FILTER

H : 123 / 121 mm
Ø : 78.5 / 77 mm
ø : M16X1,5





MOTONEIGES - QUADS SNOWMOBILE - ATV SCHNEEMOBIL - QUADS

MOTONEIGES (APPLICATIONS)

SNOWMOBILE (APPLICATIONS)
SCHNEEMOBIL (ANWENDUNGEN)

42

QUADS (APPLICATIONS)

ATV (APPLICATIONS)
QUADS (ANWENDUNGEN)

46

FILTRES POUR MOTONEIGES - QUADS

FILTERS FOR SNOWMOBILE - ATV
FILTER FÜR SCHNEEMOBIL - QUADS

72

ALPINA SNOWMOBILES
SHERPA

Type mach. MOTO NEIGE
 Année-> 2017
 Mot.make FORD
 Mot.type 1,6LTI-VCT16V
 hp/kw 115CH

SUPERCLASS

Type mach. MOTO NEIGE
 Année-> 2017
 Mot.make SUZUKI
 Mot.type 1,2LVVT
 hp/kw 92CH

ARCTIC CAT
Z 570

Type mach. MOTO NEIGE
 Ess/Be : BE 215

1000 BEAR CAT XT Z1

Type mach. MOTO NEIGE
 Mot.make SUZUKI
 Oil/Oel : SO 6999

1056 TZ1 TOURING / LXR / LXR LE

Type mach. MOTO NEIGE
 Année-> 2009
 Oil/Oel : SO 6999

1056 Z1 EFI / EFI LXR

Type mach. MOTO NEIGE
 Année-> 2009
 Oil/Oel : SO 6999

1056 Z1 TURBO SNO PRO / LXR / LXR LE

Type mach. MOTO NEIGE
 Année-> 2009
 Oil/Oel : SO 6999

5000 BEAR CAT Z1 XT

Type mach. MOTO NEIGE
 Année-> 2009
 Oil/Oel : SO 6999

550

Type mach. MOTO NEIGE
 Année-> 2003
 Mot.make SUZUKI
 Ess/Be : BE 212

660 BEAR CAT WTT

Type mach. MOTO NEIGE
 Oil/Oel : T 501
 Air/Luft : SA 8138

660 BEARCAT WIDE TRACK

Type mach. MOTO NEIGE
 Année-> 2003
 ->Année 2008
 Oil/Oel : T 1636

660 BEARCAT WIDE TRACK TURBO

Type mach. MOTO NEIGE
 Année-> 2006
 ->Année 2008
 Oil/Oel : T 1636

ARCTIC CAT
660 PANTHER TOURING

Type mach. MOTO NEIGE
 Année-> 2006
 ->Année 2008
 Oil/Oel : T 1636

660 PANTHER TRAIL

Type mach. MOTO NEIGE
 Année-> 2006
 ->Année 2007
 Oil/Oel : T 1636

660 TOURING/TRAIL

Type mach. MOTO NEIGE
 Année-> 2002
 ->Année 2003
 Oil/Oel : T 1636

660T TOURING

Type mach. MOTO NEIGE
 Année-> 2004
 ->Année 2008
 Oil/Oel : T 1636

660T TURBO

Type mach. MOTO NEIGE
 Année-> 2005
 Oil/Oel : T 1636

660T TURBO ST

Type mach. MOTO NEIGE
 Année-> 2005
 ->Année 2006
 Oil/Oel : T 1636

660T TURBO ST EFI

Type mach. MOTO NEIGE
 Année-> 2005
 Oil/Oel : T 1636

660T TURBO TOURING/TRAIL

Type mach. MOTO NEIGE
 Année-> 2004
 ->Année 2007
 Oil/Oel : T 1636

660T TURBO TRAIL LE

Type mach. MOTO NEIGE
 Année-> 2006
 Oil/Oel : T 1636

7000 BEAR CAT XT

Type mach. MOTO NEIGE
 Année-> 2017
 Oil/Oel : SO 6969
 Air/Luft : SA 8953

BOMBARDIER
VOIR AUSSI/SEE/SIEHE SKI DOO
MOTO NEIGE

Type mach. MOTO NEIGE
 Mot.make ROTAX
 Mot.type 185
 Air/Luft : SA 7979

BOMBARDIER
1000 LEGEND TOURING

Type mach. MOTO NEIGE
 Année-> 2007
 ->Année 2009
 Oil/Oel : SO 6986

1000 YETI

Type mach. MOTO NEIGE
 Année-> 2005
 Oil/Oel : SO 6977
 Ess/Be : BE 215

1000 4-TEC EXPEDITION

Type mach. MOTO NEIGE
 Année-> 2004
 Oil/Oel : SO 6977

1000-V LYNX 59 YETI

Type mach. MOTO NEIGE
 Année-> 2004
 Mot.make ROTAX
 Oil/Oel : SO 6977
 Ess/Be : BE 215

1000-V SE LEGEND

Type mach. MOTO NEIGE
 Année-> 2004
 Oil/Oel : SO 6977

1000-V SE LEGEND GT

Type mach. MOTO NEIGE
 Année-> 2004
 Oil/Oel : SO 6977

1000-V SPORT LEGEND

Type mach. MOTO NEIGE
 Année-> 2003
 ->Année 2004
 Oil/Oel : SO 6977

1000-V TUV EXPEDITION

Type mach. MOTO NEIGE
 Année-> 2005
 ->Année 2006
 Oil/Oel : SO 6977

1200 GT LYNX ADVENTURE

Type mach. MOTO NEIGE
 Année-> 2010
 Mot.make ROTAX
 Mot.type ACE
 Oil/Oel : SO 6986
 Ess/Be : BE 215

1200 LYNX ALPINE

Type mach. MOTO NEIGE
 Mot.make ROTAX
 Oil/Oel : SO 6986
 Ess/Be : BE 215

1200 69 RANGER

Type mach. MOTO NEIGE
 Mot.make ROTAX
 Oil/Oel : SO 6986
 Ess/Be : BE 215

1300 LYNX YETI V

Type mach. MOTO NEIGE
 Année-> 2005
 Mot.make ROTAX
 Oil/Oel : SO 6977
 Ess/Be : BE 215

BOMBARDIER
1300 SKI-DOO EXPEDITION

Type mach. MOTO NEIGE
 Année-> 2006
 Mot.make ROTAX
 Mot.type V1300 4-TEC
 hp/kw 103 CH
 Oil/Oel : SO 6977

1500 ELITE

Type mach. MOTO NEIGE
 Année-> 2004
 ->Année 2005
 Oil/Oel : SO 6977

600 SKANDIC SWT

Type mach. MOTO NEIGE
 Année-> 2007
 ->Année 2011
 Oil/Oel : SO 6986

800-V EXPEDITION

Type mach. MOTO NEIGE
 Année-> 2007
 ->Année 2008
 Oil/Oel : SO 6986

800-V LEGEND

Type mach. MOTO NEIGE
 Année-> 2007
 ->Année 2008
 Oil/Oel : SO 6986

800-V LYNX YETI

Type mach. MOTO NEIGE
 Oil/Oel : SO 6986

800-V TUNDRA / SKANDIC

Type mach. MOTO NEIGE
 Année-> 2007
 ->Année 2008
 Oil/Oel : SO 6986

800-V TUV 4-TEC EXPEDITION

Type mach. MOTO NEIGE
 Année-> 2009
 Oil/Oel : SO 6986

800-V YETI PRO

Type mach. MOTO NEIGE
 Année-> 2009
 Oil/Oel : SO 6986
 Ess/Be : BE 215

800-V 4-TEC TUNDRA LT/ SKANDIC

Type mach. MOTO NEIGE
 Année-> 2008
 ->Année 2009
 Oil/Oel : SO 6986

900 LYNX X TRIM ACE

Type mach. MOTO NEIGE
 Mot.make ROTAX
 Oil/Oel : SO 6986

BRP
VOIR/SEE/SIEHE BOMBARDIER

Type mach. .

CAN-AM
VOIR/SEE/SIEHE BOMBARDIER

Type mach. .

LYNX
VOIR AUSSI/SEE/SIEHE BOMBARDIER

Type mach. .

X TRIM 900 ACE

Type mach. MOTO NEIGE
 Mot.make ROTAX
 Oil/Oel : SO 6986

POLARIS
700 IQ FS/FST

Type mach. MOTO NEIGE
 Oil/Oel : SO 6942

800 INDY FRONTIER CLASSIC 4T

Type mach. MOTO NEIGE
 Année-> 2003
 ->Année 2004
 Oil/Oel : SO 6943

800 INDY FRONTIER TOURING 4T

Type mach. MOTO NEIGE
 Année-> 2002
 ->Année 2004
 Oil/Oel : SO 6943

SKI DOO
1000-V SE LEGEND

Type mach. MOTO NEIGE
 Année-> 2004
 ->Année 2005
 Oil/Oel : SO 6977

1000-V SE LEGEND GT

Type mach. MOTO NEIGE
 Année-> 2005
 Oil/Oel : SO 6977

1000-V SPORT LEGEND

Type mach. MOTO NEIGE
 Année-> 2004
 ->Année 2005
 Oil/Oel : SO 6977

1000-V TUV EXPEDITION

Type mach. MOTO NEIGE
 Année-> 2005
 ->Année 2006
 Oil/Oel : SO 6977

800-V EXPEDITION SPORT

Type mach. MOTO NEIGE
 Année-> 2007
 ->Année 2008
 Oil/Oel : SO 6986

800-V EXPEDITION TUV

Type mach. MOTO NEIGE
 Année-> 2007
 ->Année 2008
 Oil/Oel : SO 6986

SKI DOO
800-V EXPEDITION TUV YETI II

Type mach. MOTO NEIGE
 Année-> 2009
 Oil/Oel : SO 6986

800-V LEGEND TOURING

Type mach. MOTO NEIGE
 Année-> 2007
 ->Année 2009
 Oil/Oel : SO 6986

800-V LEGEND TRAIL

Type mach. MOTO NEIGE
 Année-> 2007
 ->Année 2008
 Oil/Oel : SO 6986

800-V SKANDIC SWT

Type mach. MOTO NEIGE
 Année-> 2007
 ->Année 2009
 Oil/Oel : SO 6986

800-V SKANDIC TUNDRA

Type mach. MOTO NEIGE
 Année-> 2007
 Oil/Oel : SO 6986

800-V SKANDIC TUNDRA LT

Type mach. MOTO NEIGE
 Année-> 2008
 ->Année 2009
 Oil/Oel : SO 6986

YAMAHA MOTO
EL 433 B

Type mach. MOTO NEIGE

EW 433 C

Type mach. MOTO NEIGE

EW 643 B

Type mach. MOTO NEIGE

GP 246 F

Type mach. MOTO NEIGE

GP 292

Type mach. MOTO NEIGE

GP 292 F

Type mach. MOTO NEIGE

GP 338

Type mach. MOTO NEIGE

GP 338 F

Type mach. MOTO NEIGE

GP 433 B

Type mach. MOTO NEIGE

GP 433 F

Type mach. MOTO NEIGE

YAMAHA MOTO		YAMAHA MOTO		YAMAHA MOTO	
GP 433 SR		1000 APEX RTX/ER		1000 RX WARRIOR LE	
Type mach.	MOTO NEIGE	Type mach.	MOTO NEIGE	Type mach.	MOTO NEIGE
GP 433 SS		Année->	2006	Année->	2004
Type mach.	MOTO NEIGE	->Année	2009	->Année	2005
GP 643 B		Oil/Oel :	T 59	Oil/Oel :	T 59
Type mach.	MOTO NEIGE	1000 ATTAK GT		1000 RX 1 ER	
GPX 338 F		Type mach.	MOTO NEIGE	Type mach.	MOTO NEIGE
Type mach.	MOTO NEIGE	Année->	2006	Année->	2003
GPX 433 F		->Année	2007	->Année	2005
Type mach.	MOTO NEIGE	Oil/Oel :	T 59	Oil/Oel :	T 59
SL 292		1000 RAGE/GT		1000 RX 1 MOUNTAIN LE	
Type mach.	MOTO NEIGE	Type mach.	MOTO NEIGE	Type mach.	MOTO NEIGE
SL 338 D		Année->	2006	Année->	2003
Type mach.	MOTO NEIGE	->Année	2007	->Année	2005
SL 433 B		Oil/Oel :	SO 6969	Oil/Oel :	T 59
Type mach.	MOTO NEIGE	1000 RS RAGE		1000 RX-1	
SM 292		Type mach.	MOTO NEIGE	Type mach.	MOTO NEIGE
Type mach.	MOTO NEIGE	Année->	2005	Année->	2006
SR 433 B		Oil/Oel :	SO 6969	->Année	2007
Type mach.	MOTO NEIGE	1000 RS VECTOR		Oil/Oel :	SO 6969
SW 433 C		Type mach.	MOTO NEIGE	1000 VENTUR RS	
Type mach.	MOTO NEIGE	Année->	2005	Type mach.	MOTO NEIGE
1000 APEX		Oil/Oel :	SO 6969	Oil/Oel :	T 59
Type mach.	MOTO NEIGE	1000 RS VECTOR GT		1000 VIKING PROFESSIONAL	
Année->	2007	Type mach.	MOTO NEIGE	Type mach.	MOTO NEIGE
->Année	2011	Année->	2008	Année->	2006
Oil/Oel :	T 59	->Année	2011	->Année	2011
1000 APEX ER		Oil/Oel :	SO 6969	Oil/Oel :	SO 6969
Type mach.	MOTO NEIGE	1000 RS VECTOR LT/GT		1000 VK	
Année->	2006	Type mach.	MOTO NEIGE	Type mach.	MOTO NEIGE
Oil/Oel :	T 59	Année->	2009	Année->	2005
1000 APEX GT		->Année	2011	Oil/Oel :	SO 6969
Type mach.	MOTO NEIGE	Oil/Oel :	SO 6969	1050 FX NYTRO	
Année->	2006	1000 RS VECTOR LTX/GT		Type mach.	MOTO NEIGE
->Année	2010	Type mach.	MOTO NEIGE	Année->	2009
Oil/Oel :	T 59	Année->	2008	->Année	2011
1000 APEX LTX/GT		->Année	2011	Oil/Oel :	SO 6969
Type mach.	MOTO NEIGE	Oil/Oel :	SO 6969	1050 FX NYTRO MTX	
Année->	2008	1000 RS VECTOR MOUNTAIN		Type mach.	MOTO NEIGE
->Année	2010	Type mach.	MOTO NEIGE	Année->	2008
Oil/Oel :	T 59	Année->	2005	->Année	2011
1000 APEX MOUNTAIN/SE		Oil/Oel :	SO 6969	Oil/Oel :	SO 6969
Type mach.	MOTO NEIGE	1000 RS VENTURE		1050 FX NYTRO RTX/SE	
Année->	2006	Type mach.	MOTO NEIGE	Type mach.	MOTO NEIGE
->Année	2007	Année->	2005	Année->	2008
Oil/Oel :	T 59	Oil/Oel :	T 59	->Année	2011
1000 APEX MTX/SE		1000 RS VIKING		Oil/Oel :	SO 6969
Type mach.	MOTO NEIGE	Type mach.	MOTO NEIGE	1050 FX NYTRO XTX	
Année->	2008	Année->	2008	Type mach.	MOTO NEIGE
->Année	2011	Oil/Oel :	SO 6969	Année->	2009
Oil/Oel :	T 59	1000 RS VIKING PROFESSIONAL		->Année	2011
		Type mach.	MOTO NEIGE	Oil/Oel :	SO 6969
		Année->	2008	1050 NYTRO/ER	
		Oil/Oel :	SO 6969	Type mach.	MOTO NEIGE
				Année->	2006
				->Année	2008
				Oil/Oel :	SO 6969

YAMAHA MOTO

1050 VENTURE ER GT

Type mach. MOTO NEIGE
 Année-> 2006
 ->Année 2007
 Oil/Oel : SO 6969

1050 VENTURE GT

Type mach. MOTO NEIGE
 Année-> 2007
 Oil/Oel : SO 6969

1050 VENTURE LITE

Type mach. MOTO NEIGE
 Année-> 2007
 ->Année 2011
 Oil/Oel : SO 6969

1050 VENTURE RS

Type mach. MOTO NEIGE
 Année-> 2005
 ->Année 2006
 Oil/Oel : SO 6969

1050 VENTURE RS GT

Type mach. MOTO NEIGE
 Année-> 2008
 ->Année 2011
 Oil/Oel : SO 6969

410 ENTICER TR

Type mach. MOTO NEIGE

500 PHAZER

Type mach. MOTO NEIGE
 Année-> 2007
 ->Année 2010
 Oil/Oel : SO 6969

500 PHAZER FX

Type mach. MOTO NEIGE
 Année-> 2007
 Oil/Oel : SO 6969

500 PHAZER GT

Type mach. MOTO NEIGE
 Année-> 2007
 ->Année 2011
 Oil/Oel : SO 6969

500 PHAZER MOUNTAIN LITE

Type mach. MOTO NEIGE
 Année-> 2007
 ->Année 2008
 Oil/Oel : SO 6969

500 PHAZER MTX

Type mach. MOTO NEIGE
 Année-> 2009
 ->Année 2011
 Oil/Oel : SO 6969

500 PHAZER RTX

Type mach. MOTO NEIGE
 Année-> 2008
 ->Année 2011
 Oil/Oel : SO 6969

500 VENTURE XL

Type mach. MOTO NEIGE

540 VIKING III

Type mach. MOTO NEIGE

YAMAHA MOTO

700 SRX

Type mach. MOTO NEIGE

700 SX VIPER

Type mach. MOTO NEIGE

700 VENTURE

Type mach. MOTO NEIGE



QUADS | ATV | QUADS

ACCESS MOTOR

450 APACHE
Type mach. QUAD
Oil/Oel : T 59

450 SP S
Type mach. QUAD
Oil/Oel : T 59

450 SP SM SUPERMOTO

Type mach. QUAD
Oil/Oel : T 59

450 SP SPORT
Type mach. QUAD
Oil/Oel : T 59

450 WARRIOR
Type mach. QUAD
Oil/Oel : T 59

700 AX
Type mach. QUAD
Oil/Oel : T 59

ADLY

200 S ATV
Type mach. QUAD
Oil/Oel : SO 6985

220 S SENTINAL
Type mach. QUAD
Oil/Oel : SO 6985

300 CRUSADER UTILITAIRE
Type mach. QUAD
Année-> 2005
Air/Luft : SA 8989

300 INTERCEPTOR
Type mach. QUAD
Année-> 2005
Air/Luft : SA 8989

300 THUNDERBIKE
Type mach. QUAD
Année-> 2004
Air/Luft : SA 8989

300 UTILITAIRE
Type mach. QUAD
Année-> 2004
Air/Luft : SA 8989

500 FLAT LOF
Type mach. QUAD
Oil/Oel : SO 6994

500 S HURRICANE
Type mach. QUAD
Oil/Oel : SO 6994

AEON MOTORCYCLES

COBRA 180
Type mach. QUAD

APACHE

450 RLX SPORT
Type mach. QUAD
Oil/Oel : T 59

500 RLX 4X4 LANDOWNER
Type mach. QUAD
Oil/Oel : T 501

ARCTIC CAT

1000 I GT
Type mach. QUAD
Année-> 2012
Oil/Oel : SO 6957

1000 MUD PRO LTD
Type mach. QUAD
Année-> 2010
->Année 2014
Oil/Oel : SO 6957

1000 MUD PRO LTD EPS
Type mach. QUAD
Année-> 2015
Oil/Oel : SO 6957

1000 MUD PRO LTD EPS SE
Type mach. QUAD
Année-> 2016
Oil/Oel : SO 6957

1000 S H2
Type mach. QUAD
Année-> 2011
Oil/Oel : SO 6957

1000 THUNDERCAT H2
Type mach. QUAD
Année-> 2008
->Année 2010
Oil/Oel : SO 6957

1000 THUNDERCAT H2 LE
Type mach. QUAD
Année-> 2010
Oil/Oel : SO 6957

1000 TRV H2 EFI CRUISER
Type mach. QUAD
Année-> 2009
->Année 2010
Oil/Oel : SO 6957

1000 TRV LTD
Type mach. QUAD
Année-> 2013
->Année 2015
Oil/Oel : SO 6957

1000 TRV S H2 EFI CRUISER
Type mach. QUAD
Année-> 2011
Oil/Oel : SO 6957

ARCTIC CAT

1000 TRV XT EPS
Type mach. QUAD
Année-> 2015
Oil/Oel : SO 6957

1000 XT
Type mach. QUAD
Année-> 2013
->Année 2016
Oil/Oel : SO 6957

1000 XT EPS
Type mach. QUAD
Année-> 2015
Oil/Oel : SO 6957

1000 XTZ PROWLER
Type mach. QUAD
Année-> 2013
Oil/Oel : SO 6957

250
Type mach. QUAD
Année-> 1999
->Année 2005
Mot.make SUZUKI
Oil/Oel : SO 6988

250 DVX
Type mach. QUAD
Année-> 2006

250 2X4
Type mach. QUAD
Année-> 1999
->Année 2005
Air/Luft : SA 8990

250 2X4
Type mach. QUAD
Année-> 2006

250 4X4
Type mach. QUAD
Année-> 2001
->Année 2005
Air/Luft : SA 8990

300 2X4
Type mach. QUAD
Année-> 1998
->Année 2003
Mot.make SUZUKI
Oil/Oel : SO 6988
Air/Luft : SA 8990

300 4X4
Type mach. QUAD
Année-> 1998
->Année 2005
Mot.make SUZUKI
Oil/Oel : SO 6988
Air/Luft : SA 8990

300 4X4
Type mach. QUAD
Année-> 1998
->Année 2005
Mot.make SUZUKI
Oil/Oel : SO 6988
Air/Luft : SA 8990

350 CR
Type mach. QUAD
Année-> 2011
->Année 2012
Oil/Oel : SO 6957
Air/Luft : SA 7940

ARCTIC CAT

366 SE METALLIC BLACK

Type mach. QUAD
Année-> 2010
->Année 2011
Oil/Oel : SO 6957
Air/Luft : SA 7940

366 4X4 AUTO

Type mach. QUAD
Année-> 2008
->Année 2009
Oil/Oel : SO 6957
Air/Luft : SA 7940

375 2X4

Type mach. QUAD
Année-> 2002
Air/Luft : SA 8991

375 4X4

Type mach. QUAD
Année-> 2002
Air/Luft : SA 8991

400

Type mach. QUAD
Année-> 1998
->Année 2005
Mot.make SUZUKI
Oil/Oel : SO 6999
Air/Luft : SA 8991

400 ALTERRA

Type mach. QUAD
Année-> 2016
->Année 2017
Oil/Oel : SO 6957

400 ATV CR/INTERNATIONAL

Type mach. QUAD
Année-> 2015
Oil/Oel : SO 6957

400 DVX

Type mach. QUAD
Année-> 2004
->Année 2006

Oil/Oel : SO 6979
Air/Luft : SA 7940

400 DVX

Type mach. QUAD
Année-> 2007
Oil/Oel : SO 6979
Air/Luft : SA 7940

400 DVX TS

Type mach. QUAD
Année-> 2006
Oil/Oel : SO 6979
Air/Luft : SA 7940

400 DVX TS

Type mach. QUAD
Année-> 2007
Oil/Oel : SO 6979
Air/Luft : SA 7940

400 TRV CORE

Type mach. QUAD
Année-> 2013
Oil/Oel : SO 6957

ARCTIC CAT

400 2X4 AUTO

Type mach. QUAD
Année-> 2003
->Année 2004

Oil/Oel : SO 6999

400 4X4

Type mach. QUAD
Année-> 1998
->Année 2005
Mot.make SUZUKI
Oil/Oel : SO 6999
Air/Luft : SA 8991

400 4X4

Type mach. QUAD
Année-> 2006
Oil/Oel : SO 6999
Air/Luft : SA 8988

400 4X4 ACT

Type mach. QUAD
Année-> 2003
->Année 2004
Oil/Oel : SO 6999
Air/Luft : SA 8991

400 4X4 ACT AUTO

Type mach. QUAD
Année-> 2003
->Année 2004
Oil/Oel : SO 6999
Air/Luft : SA 8991

400 4X4 AUTO LE

Type mach. QUAD
Année-> 2006
Oil/Oel : SO 6999
Air/Luft : SA 8988

400 4X4 AUTO LE

Type mach. QUAD
Année-> 2005
Oil/Oel : SO 6999
Air/Luft : SA 8991

400 4X4 AUTO MRP

Type mach. QUAD
Année-> 2003
Oil/Oel : SO 6999
Air/Luft : SA 8991

400 4X4 AUTO TBX

Type mach. QUAD
Année-> 2006
Oil/Oel : SO 6999
Air/Luft : SA 8988

400 4X4 AUTO TRV

Type mach. QUAD
Année-> 2006
Oil/Oel : SO 6999
Air/Luft : SA 8988

400 4X4 AUTO TRV PLUS

Type mach. QUAD
Année-> 2007
Oil/Oel : SO 6999
Air/Luft : SA 8988

ARCTIC CAT

400 4X4 AUTO VP

Type mach. QUAD
Année-> 2005
->Année 2006

Oil/Oel : SO 6999

Air/Luft : SA 8991

400 4X4 TBX

Type mach. QUAD
Année-> 2004
->Année 2005

Oil/Oel : SO 6999

Air/Luft : SA 8991

400 4X4 VP

Type mach. QUAD
Année-> 2005
->Année 2006

Oil/Oel : SO 6999

Air/Luft : SA 8991

425 CR

Type mach. QUAD
Année-> 2011
->Année 2012

Oil/Oel : SO 6957

Air/Luft : SA 7940

425 CR EFI/SE

Type mach. QUAD
Année-> 2011
->Année 2012

Oil/Oel : SO 6957

Air/Luft : SA 7940

450

Type mach. QUAD
->Année 1998
Mot.make SUZUKI

Oil/Oel : SO 6999

450 ALTERRA

Type mach. QUAD
Année-> 2016
Oil/Oel : SO 6957

450 ATV EFT/INTERNATIONAL

Type mach. QUAD
Année-> 2015
Oil/Oel : SO 6957

450 CORE

Type mach. QUAD
Année-> 2013
Oil/Oel : SO 6957

450 EFI

Type mach. QUAD
Année-> 2011
Oil/Oel : SO 6957

450 HF ALTERRA

Type mach. QUAD
Année-> 2017
Oil/Oel : SO 6960

450 H1 EFI

Type mach. QUAD
Année-> 2010
Oil/Oel : SO 6957



QUADS | ATV | QUADS

ARCTIC CAT		ARCTIC CAT		ARCTIC CAT	
450 I		500 XT		500 4X4 AUTO TRV	
Type mach.	QUAD	Type mach.	QUAD	Type mach.	QUAD
Année->	2012	Année->	2013	Année->	2005
Oil/Oel :	SO 6957	Oil/Oel :	SO 6957	Oil/Oel :	SO 6999
450 I TRV		500 4X4		550 ALTERRA TRV XT EPS	
Type mach.	QUAD	Type mach.	QUAD	Type mach.	QUAD
Année->	2012	Année->	1998	Année->	2017
Oil/Oel :	SO 6957	Mot.make	SUZUKI	Oil/Oel :	SO 6957
450 I XC/EFI/EFT/INTERNATIONAL		Oil/Oel :	SO 6999	550 CORE	
Type mach.	QUAD	Air/Luft :	SA 8991	Type mach.	QUAD
Année->	2011	500 4X4		Année->	2013
->Année	2015	Type mach.	QUAD	->Année	2014
Oil/Oel :	SO 6957	Année->	2005	Oil/Oel :	SO 6957
450 LTD		Oil/Oel :	SO 6999	550 H1 EFI	
Type mach.	QUAD	Air/Luft :	SA 8988	Type mach.	QUAD
Année->	2011	500 4X4 AUTO		Année->	2009
Oil/Oel :	SO 6957	Type mach.	QUAD	->Année	2012
450 TRV		Année->	1999	Oil/Oel :	SO 6957
Type mach.	QUAD	Mot.make	SUZUKI	550 I GT	
Année->	2011	Oil/Oel :	SO 6999	Type mach.	QUAD
Oil/Oel :	SO 6957	Air/Luft :	SA 8991	Année->	2012
450 TRV EFI		Hydraulic:	CR 30/3	Oil/Oel :	SO 6957
Type mach.	QUAD	500 4X4 AUTO		550 I LTD	
Année->	2011	Type mach.	QUAD	Type mach.	QUAD
Oil/Oel :	SO 6957	Année->	2005	Année->	2013
450 XC		Oil/Oel :	SO 6999	->Année	2014
Type mach.	QUAD	Air/Luft :	SA 8988	Oil/Oel :	SO 6957
Air/Luft :	SA 7940	500 4X4 AUTO LE		550 I TRV CRUISER EFI	
450 XC		Type mach.	QUAD	Type mach.	QUAD
Type mach.	QUAD	Année->	2005	Année->	2012
Année->	2013	Oil/Oel :	SO 6999	Oil/Oel :	SO 6957
Oil/Oel :	SO 6957	Air/Luft :	SA 8988	550 I 4X4 PROWLER XT	
454 2X4		500 4X4 AUTO LE		Type mach.	QUAD
Type mach.	QUAD	Type mach.	QUAD	Année->	2012
Année->	1996	Année->	2005	Oil/Oel :	SO 6957
->Année	1998	->Année	2006	550 LTD	
Oil/Oel :	SO 6999	Oil/Oel :	SO 6999	Type mach.	QUAD
Air/Luft :	SA 8991	Air/Luft :	SA 8988	Année->	2013
454 4X4		500 4X4 AUTO MRP		->Année	2014
Type mach.	QUAD	Type mach.	QUAD	Oil/Oel :	SO 6957
Année->	1996	Année->	2003	550 TRV H1 EFI	
->Année	1998	->Année	2004	Type mach.	QUAD
Oil/Oel :	SO 6999	Oil/Oel :	SO 6999	Année->	2009
Air/Luft :	SA 8991	500 4X4 AUTO M4		->Année	2010
500 CORE		Oil/Oel :	SO 6957	Oil/Oel :	SO 6957
Type mach.	QUAD	Air/Luft :	SA 8988	550 TRV H1 EFI	
Année->	2013	500 4X4 AUTO TBX		Type mach.	QUAD
->Année	2014	Type mach.	QUAD	Année->	2011
Oil/Oel :	SO 6957	Année->	2005	Oil/Oel :	SO 6957
500 CORE EFI		Oil/Oel :	SO 6999	550 TRV H1 EFI LE	
Type mach.	QUAD	Air/Luft :	SA 8988	Type mach.	QUAD
Année->	2013	500 4X4 AUTO TBX		Année->	2009
Oil/Oel :	SO 6957	Type mach.	QUAD	Oil/Oel :	SO 6957
500 CORE TRV		Année->	2002	550 TRV LTD	
Type mach.	QUAD	Oil/Oel :	SO 6999	Type mach.	QUAD
Année->	2013	Air/Luft :	SA 8991	Année->	2013
->Année	2015			Oil/Oel :	SO 6957
Oil/Oel :	SO 6957				

ARCTIC CAT

550 TRV S GT

Type mach. QUAD
Année-> 2010
Oil/Oel : SO 6957

550 TRV S H1 CRUISER EFI

Type mach. QUAD
Année-> 2011
Oil/Oel : SO 6957

550 TRV S H1 FT EFI

Type mach. QUAD
Année-> 2011
Oil/Oel : SO 6957

550 TRV XT

Type mach. QUAD
Année-> 2013
Oil/Oel : SO 6957

550 XR

Type mach. QUAD
Année-> 2015
Oil/Oel : SO 6957

550 XT

Type mach. QUAD
Année-> 2013
->Année 2014
Oil/Oel : SO 6957

550 XT EPS

Type mach. QUAD
Année-> 2015
Oil/Oel : SO 6957

600 4X4

Type mach. QUAD
Année-> 2004
Oil/Oel : SO 6955

650 H1 PROWLER XT

Type mach. QUAD
Année-> 2006
Oil/Oel : SO 6999
Air/Luft : SA 8988

650 H1 4X4 AUTO

Type mach. QUAD
Année-> 2005
Oil/Oel : SO 6999
Air/Luft : SA 8988

650 H1 4X4 AUTO TBX

Type mach. QUAD
Année-> 2007
Oil/Oel : SO 6957
Air/Luft : SA 8988

650 H1 4X4 AUTO TRV

Type mach. QUAD
Année-> 2008
Oil/Oel : SO 6957

650 H1 4X4 AUTO TRV

Type mach. QUAD
Année-> 2007
Oil/Oel : SO 6957
Air/Luft : SA 8988

ARCTIC CAT

650 H1 4X4 SE

Type mach. QUAD
Année-> 2006
Oil/Oel : SO 6999
Air/Luft : SA 8988

650 V2 4X4

Type mach. QUAD
Année-> 2006
Oil/Oel : SO 6955
Air/Luft : SA 8988

650 V2 4X4 AUTO

Type mach. QUAD
Année-> 2005
Oil/Oel : SO 6955
Air/Luft : SA 8988

650 V2 4X4 AUTO LE

Type mach. QUAD
Année-> 2005
Oil/Oel : SO 6955
Air/Luft : SA 8988

650 V2 4X4 LE TS

Type mach. QUAD
Année-> 2006
Oil/Oel : SO 6955
Air/Luft : SA 8988

650 4X4 AUTO

Type mach. QUAD
Année-> 2004
Oil/Oel : SO 6955
Air/Luft : SA 8988

650 4X4 AUTO LE

Type mach. QUAD
Année-> 2004
Oil/Oel : SO 6955
Air/Luft : SA 8988

650 4X4 MUDPRO

Type mach. QUAD
Année-> 2010
->Année 2011
Oil/Oel : SO 6957

700 ALTERRA

Type mach. QUAD
Année-> 2017
Oil/Oel : SO 6957

700 ALTERRA TRV XT EPS

Type mach. QUAD
Année-> 2017
Oil/Oel : SO 6957

700 ALTERRA XT EPS

Type mach. QUAD
Année-> 2017
Oil/Oel : SO 6957

700 CORE

Type mach. QUAD
Année-> 2013
->Année 2014
Oil/Oel : SO 6957

ARCTIC CAT

700 HDX CREW XT

Type mach. QUAD
Année-> 2017
Oil/Oel : SO 6957

700 HDX XT

Type mach. QUAD
Année-> 2017
Oil/Oel : SO 6957

700 H1

Type mach. QUAD
Année-> 2009
->Année 2012
Oil/Oel : SO 6957

700 H1 EFI MUDPRO

Type mach. QUAD
Année-> 2009
->Année 2012
Oil/Oel : SO 6957

700 I

Type mach. QUAD
Année-> 2012
Oil/Oel : SO 6957

700 I GT

Type mach. QUAD
Année-> 2012
Oil/Oel : SO 6957

700 I LTD

Type mach. QUAD
Année-> 2012
->Année 2014
Oil/Oel : SO 6957

700 I MUDPRO

Type mach. QUAD
Année-> 2012
Oil/Oel : SO 6957

700 I MUDPRO LTD

Type mach. QUAD
Année-> 2012
Oil/Oel : SO 6957

700 I MUDPRO LTD

Type mach. QUAD
Année-> 2013
->Année 2014
Oil/Oel : SO 6957

700 I MUDPRO LTD EPS

Type mach. QUAD
Année-> 2017
Oil/Oel : SO 6957

700 TBX EPS

Type mach. QUAD
Année-> 2015
Oil/Oel : SO 6957

700 TRV I GT

Type mach. QUAD
Année-> 2012
Oil/Oel : SO 6957



ARCTIC CAT

700 TRV LTD

Type mach. QUAD
Année-> 2013
->Année 2014

Oil/Oel : SO 6957

700 TRV XT

Type mach. QUAD
Année-> 2013
->Année 2014

Oil/Oel : SO 6957

700 XT

Type mach. QUAD
Année-> 2013
->Année 2014

Oil/Oel : SO 6957

700 XTX PROWLER 4X4

Type mach. QUAD
Année-> 2010

Oil/Oel : SO 6957

700 4X4 AUTO FIS EFI

Type mach. QUAD
Année-> 2008

Oil/Oel : SO 6957

700 4X4 AUTO LE EFI

Type mach. QUAD
Année-> 2007

Oil/Oel : SO 6957

700 4X4 AUTO M4 EFI

Type mach. QUAD
Année-> 2008

Oil/Oel : SO 6957

700 4X4 AUTO TRV EFI

Type mach. QUAD
Année-> 2008

Oil/Oel : SO 6957

700 4X4 AUTO TRV LE EFI

Type mach. QUAD
Année-> 2008

Oil/Oel : SO 6957

AXR

100 4 CROSS

Type mach. QUAD

200 4 CROSS

Type mach. QUAD

250 UT

Type mach. QUAD
Année-> 2004

Air/Luft : SA 8987

300 SP

Type mach. QUAD
Année-> 2004

Air/Luft : SA 8989

50 4 CROSS

Type mach. QUAD

BAROSSA

170 MAGNA

Type mach. QUAD
Année-> 2004

170 R

Type mach. QUAD
Année-> 2005

250 QUATERBACK

Type mach. QUAD
Année-> 2004

250 R

Type mach. QUAD
Année-> 2005

250 SILVERHAWK

Type mach. QUAD
Année-> 2004

BOMBARDIER

1000 COMMANDER XT

Type mach. QUAD
Oil/Oel : SO 6986

1000 OUTLANDER

Type mach. QUAD
Année-> 2012
->Année 2014

Oil/Oel : SO 6986

1000 OUTLANDER DPS

Type mach. QUAD
Année-> 2013
->Année 2014

Oil/Oel : SO 6986
Air/Luft : SA 7534

1000 OUTLANDER MAX DPS

Type mach. QUAD
Année-> 2013
->Année 2014

Oil/Oel : SO 6986
Air/Luft : SA 7534

1000 OUTLANDER MAX LTD

Type mach. QUAD
Année-> 2013
->Année 2014

Oil/Oel : SO 6986
Air/Luft : SA 7534

1000 OUTLANDER MAX XT

Type mach. QUAD
Année-> 2013
->Année 2014

Oil/Oel : SO 6986
Air/Luft : SA 7534

1000 OUTLANDER MAX XT-P

Type mach. QUAD
Année-> 2013
->Année 2014

Oil/Oel : SO 6986
Air/Luft : SA 7534

1000 OUTLANDER R DPS

Type mach. QUAD
Année-> 2016

Oil/Oel : SO 6986
Air/Luft : SA 7534

BOMBARDIER

1000 OUTLANDER R MAX EFI

Type mach. QUAD
Année-> 2015
->Année 2016

Oil/Oel : SO 6986

Air/Luft : SA 7534

1000 OUTLANDER R MAX LTD

Type mach. QUAD
Année-> 2017

Oil/Oel : SO 6986

Air/Luft : SA 7534

1000 OUTLANDER R MAX XT

Type mach. QUAD
Année-> 2017

Oil/Oel : SO 6986

Air/Luft : SA 7534

1000 OUTLANDER R MAX XT

Type mach. QUAD
Année-> 2017

Oil/Oel : SO 6986

Air/Luft : SA 7534

1000 OUTLANDER R MOSSY OAK HUNTING ED.

Type mach. QUAD
Année-> 2017

Oil/Oel : SO 6986

Air/Luft : SA 7534

1000 OUTLANDER R X MR EFI

Type mach. QUAD
Année-> 2015
->Année 2017

Oil/Oel : SO 6986

Air/Luft : SA 7534

1000 OUTLANDER R XT

Type mach. QUAD
Année-> 2016
->Année 2017

Oil/Oel : SO 6986

Air/Luft : SA 7534

1000 OUTLANDER R XT-P

Type mach. QUAD
Année-> 2016
->Année 2017

Oil/Oel : SO 6986

Air/Luft : SA 7534

1000 OUTLANDER X MR EFI

Type mach. QUAD
Année-> 2015

Oil/Oel : SO 6986

Air/Luft : SA 7534

1000 OUTLANDER XT

Type mach. QUAD
Année-> 2012
->Année 2014

Oil/Oel : SO 6986

Air/Luft : SA 7534

1000 OUTLANDER XT-P

Type mach. QUAD
Année-> 2013
->Année 2014

Oil/Oel : SO 6986

Air/Luft : SA 7534

BOMBARDIER

1000 OUTLANDER 6X6 EFI

Type mach. QUAD
 Année-> 2015
 ->Année 2016
 Oil/Oel : SO 6986
 Air/Luft : SA 7534

1000 OUTLANDER 6X6 XT EFI

Type mach. QUAD
 Année-> 2016
 ->Année 2017
 Oil/Oel : SO 6986
 Air/Luft : SA 7534

1000 RENEGADE

Type mach. QUAD
 Année-> 2012
 ->Année 2014
 Oil/Oel : SO 6986
 Air/Luft : SA 7534

1000 RENEGADE X MR

Type mach. QUAD
 Année-> 2017
 Oil/Oel : SO 6986
 Air/Luft : SA 7534

1000 RENEGADE XXC

Type mach. QUAD
 Année-> 2012
 ->Année 2014
 Oil/Oel : SO 6986
 Air/Luft : SA 7534

200 RALLY

Type mach. QUAD
 Année-> 2006
 Oil/Oel : SO 6981

200 RALLY

Type mach. QUAD
 Année-> 2002
 Mot.make ROTAX
 Oil/Oel : SO 6981

330 OUTLANDER HO

Type mach. QUAD
 Année-> 2003
 Oil/Oel : SO 6986
 Air/Luft : SA 8985

330 OUTLANDER HO 2X4

Type mach. QUAD
 Année-> 2004
 Oil/Oel : SO 6986
 Air/Luft : SA 8985

330 OUTLANDER HO 4X4

Type mach. QUAD
 Année-> 2004
 Oil/Oel : SO 6986
 Air/Luft : SA 8985

400 OUTLANDER

Type mach. QUAD
 Année-> 2003
 Air/Luft : SA 8985

400 OUTLANDER EFI

Type mach. QUAD
 Année-> 2009
 ->Année 2014
 Oil/Oel : SO 6986

BOMBARDIER

400 OUTLANDER EFI XT

Type mach. QUAD
 Année-> 2011
 ->Année 2012
 Oil/Oel : SO 6986

400 OUTLANDER EFI XT

Type mach. QUAD
 Année-> 2013
 ->Année 2014
 Oil/Oel : SO 6986

400 OUTLANDER HO

Type mach. QUAD
 Année-> 2007
 ->Année 2008
 Oil/Oel : SO 6986
 Air/Luft : SA 8985

400 OUTLANDER HO XT

Type mach. QUAD
 Année-> 2007
 ->Année 2008
 Oil/Oel : SO 6986
 Air/Luft : SA 8985

400 OUTLANDER HO 4X4

Type mach. QUAD
 Année-> 2003
 Oil/Oel : SO 6986
 Air/Luft : SA 8985

400 OUTLANDER MAX EFI / HT

Type mach. QUAD
 Année-> 2009
 ->Année 2012
 Oil/Oel : SO 6986

400 OUTLANDER MAX HO

Type mach. QUAD
 Année-> 2004
 ->Année 2008
 Oil/Oel : SO 6986
 Air/Luft : SA 8985

400 OUTLANDER MAX HO XT

Type mach. QUAD
 Année-> 2007
 ->Année 2008
 Oil/Oel : SO 6986
 Air/Luft : SA 8985

400 OUTLANDER MAX HO 4X4

Type mach. QUAD
 Année-> 2004
 Mot.make ROTAX
 Oil/Oel : SO 6986
 Air/Luft : SA 8985

400 OUTLANDER 4X4

Type mach. QUAD
 Année-> 2006
 Oil/Oel : SO 6986
 Air/Luft : SA 8985

400 OUTLANDER 400 HO 2X4

Type mach. QUAD
 Année-> 2004
 Oil/Oel : SO 6986
 Air/Luft : SA 8985

BOMBARDIER

400 OUTLANDER 400 HO 4X4 XT

Type mach. QUAD
 Année-> 2003
 ->Année 2006
 Oil/Oel : SO 6986
 Air/Luft : SA 8985

450 DS

Type mach. QUAD
 Année-> 2008
 ->Année 2014
 Oil/Oel : SO 6951

450 DS EFI / X

Type mach. QUAD
 Année-> 2009
 ->Année 2012
 Oil/Oel : SO 6951

450 DS EFI X MX

Type mach. QUAD
 Année-> 2009
 ->Année 2013
 Oil/Oel : SO 6951

450 DS EFI X XC

Type mach. QUAD
 Année-> 2009
 ->Année 2012
 Oil/Oel : SO 6951

450 DS X

Type mach. QUAD
 Année-> 2008
 Oil/Oel : SO 6951

450 DS X MX

Type mach. QUAD
 Année-> 2014
 Oil/Oel : SO 6951

450 DS X XC

Type mach. QUAD
 Année-> 2014
 Oil/Oel : SO 6951

500 OUTLANDER EFI

Type mach. QUAD
 Année-> 2009

500 OUTLANDER EFI

Type mach. QUAD
 Année-> 2013
 ->Année 2014
 Oil/Oel : SO 6986
 Air/Luft : SA 7534

500 OUTLANDER EFI DPS

Type mach. QUAD
 Année-> 2013
 ->Année 2014
 Oil/Oel : SO 6986
 Air/Luft : SA 7534

500 OUTLANDER EFI XT

Type mach. QUAD
 Année-> 2009
 ->Année 2012
 Oil/Oel : SO 6986



BOMBARDIER		BOMBARDIER		BOMBARDIER	
500 OUTLANDER HO EFI		500 QUEST		650 OUTLANDER EFI	
Type mach.	QUAD	Type mach.	QUAD	Type mach.	QUAD
Année->	2007	Année->	2003	Année->	2013
->Année	2008	->Année	2004	->Année	2014
Oil/Oel :	SO 6986	Oil/Oel :	SO 6977	Oil/Oel :	SO 6986
Air/Luft :	SA 7534	Air/Luft :		Air/Luft :	SA 7534
500 OUTLANDER HO EFI XT		500 RENEGADE / EFI		650 OUTLANDER EFI	
Type mach.	QUAD	Type mach.	QUAD	Type mach.	QUAD
Année->	2009	Année->	2008	Année->	2007
->Année	2012	->Année	2012	->Année	2008
Oil/Oel :	SO 6986	Oil/Oel :	SO 6986	Oil/Oel :	SO 6986
Air/Luft :	SA 7534	Air/Luft :		Air/Luft :	SA 7534
500 OUTLANDER HO EFI XT		500 RENEGADE EFI		650 OUTLANDER EFI	
Type mach.	QUAD	Type mach.	QUAD	Type mach.	QUAD
Année->	2007	Année->	2013	Année->	2013
->Année	2008	->Année	2014	->Année	2014
Oil/Oel :	SO 6986	Oil/Oel :	SO 6986	Oil/Oel :	SO 6986
Air/Luft :	SA 7534	Air/Luft :		Air/Luft :	SA 7534
500 OUTLANDER MAX EFI		500 TRAXTER AUTO CVT		650 OUTLANDER EFI	
Type mach.	QUAD	Type mach.	QUAD	Type mach.	QUAD
Année->	2009	Année->	2005	Année->	2010
->Année	2012	->Année	2005	->Année	2012
Oil/Oel :	SO 6986	Oil/Oel :	SO 6977	Oil/Oel :	SO 6986
Air/Luft :	SA 7534	Air/Luft :		Air/Luft :	SA 7534
500 OUTLANDER MAX EFI		500 TRAXTER MAX		650 OUTLANDER EFI	
Type mach.	QUAD	Type mach.	QUAD	Type mach.	QUAD
Année->	2013	Année->	2003	Année->	2010
->Année	2014	->Année	2005	->Année	2012
Oil/Oel :	SO 6986	Oil/Oel :	SO 6983	Oil/Oel :	SO 6986
Air/Luft :	SA 7534	Air/Luft :	SA 8984	Air/Luft :	SA 7534
500 OUTLANDER MAX EFI		500 TRAXTER XL		650 OUTLANDER EFI DPS	
Type mach.	QUAD	Type mach.	QUAD	Type mach.	QUAD
Année->	2013	Année->	2004	Année->	2013
->Année	2014	->Année	2004	->Année	2014
Oil/Oel :	SO 6986	Oil/Oel :	SA 8984	Oil/Oel :	SO 6986
Air/Luft :	SA 7534	Air/Luft :		Air/Luft :	SA 7534
500 OUTLANDER MAX EFI DPS		500 TRAXTER XT 4X4		650 OUTLANDER EFI XT	
Type mach.	QUAD	Type mach.	QUAD	Type mach.	QUAD
Année->	2013	Année->	2003	Année->	2009
->Année	2014	->Année	2003	->Année	2014
Oil/Oel :	SO 6986	Oil/Oel :	SO 6983	Oil/Oel :	SO 6986
Air/Luft :	SA 7534	Air/Luft :	SA 8984	Air/Luft :	SA 7534
500 OUTLANDER MAX EFI XT		500 TRAXTER 4X4		650 OUTLANDER EFI XT	
Type mach.	QUAD	Type mach.	QUAD	Type mach.	QUAD
Année->	2009	Année->	1999	Année->	2013
->Année	2013	->Année	2005	->Année	2014
Oil/Oel :	SO 6986	Oil/Oel :	SO 6983	Oil/Oel :	SO 6986
Air/Luft :	SA 7534	Air/Luft :	SA 8984	Air/Luft :	SA 7534
500 OUTLANDER MAX EFI XT		650 BAJA X		650 OUTLANDER EFI XT	
Type mach.	QUAD	Type mach.	QUAD	Type mach.	QUAD
Année->	2014	Année->	2004	Année->	2010
->Année	2014	->Année	2004	->Année	2012
Oil/Oel :	SO 6986	Oil/Oel :	SO 6986	Oil/Oel :	SO 6986
Air/Luft :	SA 7534	Air/Luft :	SA 8993	Air/Luft :	SA 7534
500 OUTLANDER MAX HO EFI		650 DS		650 OUTLANDER EFI XT	
Type mach.	QUAD	Type mach.	QUAD	Type mach.	QUAD
Année->	2007	Année->	2000	Année->	2007
->Année	2008	->Année	2005	->Année	2008
Oil/Oel :	SO 6986	Mot.make	ROTAX	Oil/Oel :	SO 6986
Air/Luft :	SA 7534	Oil/Oel :	SO 7110	Air/Luft :	SA 7534
500 OUTLANDER MAX HO EFI XT		650 DS X		650 OUTLANDER MAX	
Type mach.	QUAD	Type mach.	QUAD	Type mach.	QUAD
Année->	2007	Année->	2006	Année->	2006
->Année	2008	->Année	2006	->Année	2006
Oil/Oel :	SO 6986	Oil/Oel :	SO 6986	Oil/Oel :	SO 6986
Air/Luft :	SA 7534	Air/Luft :	SA 8984	Ess/Be :	BE 215
500 QUEST		650 OUTLANDER EFI		650 OUTLANDER MAX EFI	
Type mach.	QUAD	Type mach.	QUAD	Type mach.	QUAD
Année->	2002	Année->	2009	Année->	2009
Air/Luft :	SA 8984	Oil/Oel :	SO 6986	Oil/Oel :	SO 6986
		Air/Luft :	SA 7534	Air/Luft :	SA 7534

BOMBARDIER

650 OUTLANDER MAX EFI

Type mach. QUAD
Année-> 2010
->Année 2012
Oil/Oel : SO 6986
Air/Luft : SA 7534

650 OUTLANDER MAX EFI

Type mach. QUAD
Année-> 2013
->Année 2014
Oil/Oel : SO 6986
Air/Luft : SA 7534

650 OUTLANDER MAX EFI XT

Type mach. QUAD
Année-> 2009
Oil/Oel : SO 6986
Air/Luft : SA 7534

650 OUTLANDER MAX EFI XT

Type mach. QUAD
Année-> 2013
->Année 2014
Oil/Oel : SO 6986
Air/Luft : SA 7534

650 OUTLANDER MAX EFI XT

Type mach. QUAD
Année-> 2010
->Année 2012
Oil/Oel : SO 6986
Air/Luft : SA 7534

650 OUTLANDER MAX EFI XT-P

Type mach. QUAD
Année-> 2011
->Année 2012
Oil/Oel : SO 6986
Air/Luft : SA 7534

650 OUTLANDER MAX HO EFI

Type mach. QUAD
Année-> 2007
->Année 2008
Oil/Oel : SO 6986
Air/Luft : SA 7534

650 OUTLANDER MAX HO EFI XT

Type mach. QUAD
Année-> 2007
->Année 2008
Oil/Oel : SO 6986
Air/Luft : SA 7534

650 OUTLANDER 4X4

Type mach. QUAD
Année-> 2006
Oil/Oel : SO 6986
Ess/Be : BE 215
Air/Luft : SA 7534

650 QUEST

Type mach. QUAD
Année-> 2002
Mot.make ROTAX
Oil/Oel : SO 6977
Air/Luft : SA 8984

BOMBARDIER

650 QUEST MAX

Type mach. QUAD
Année-> 2002
Mot.make ROTAX
Oil/Oel : SO 6977
Air/Luft : SA 8984

650 QUEST XT 6

Type mach. QUAD
Année-> 2002
Mot.make ROTAX
Oil/Oel : SO 6977
Air/Luft : SA 8984

650 TRAXTER

Type mach. QUAD
Année-> 2005
Air/Luft : SA 8984

650 TRAXTER MAX

Type mach. QUAD
Année-> 2005
Air/Luft : SA 8984

800 OUTLANDER HO EFI

Type mach. QUAD
Année-> 2007
->Année 2008
Oil/Oel : SO 6986
Air/Luft : SA 7534

800 OUTLANDER HO EFI XT

Type mach. QUAD
Année-> 2007
->Année 2008
Oil/Oel : SO 6986
Air/Luft : SA 7534

800 OUTLANDER MAX EFI XT

Type mach. QUAD
Année-> 2013
->Année 2014
Oil/Oel : SO 6986
Air/Luft : SA 7534

800 OUTLANDER MAX HO EFI

Type mach. QUAD
Année-> 2007
->Année 2008
Oil/Oel : SO 6986
Air/Luft : SA 7534

800 OUTLANDER MAX HO EFI LTD/XT

Type mach. QUAD
Année-> 2007
->Année 2008
Oil/Oel : SO 6986
Air/Luft : SA 7534

800 OUTLANDER MAX LTD 4X4

Type mach. QUAD
Année-> 2006
Oil/Oel : SO 6986
Ess/Be : BE 215

800 OUTLANDER MAX 4X4

Type mach. QUAD
Année-> 2006
Oil/Oel : SO 6986
Ess/Be : BE 215

BOMBARDIER

800 OUTLANDER 4X4

Type mach. QUAD
Année-> 2006
Oil/Oel : SO 6986
Ess/Be : BE 215

800 R OUTLANDER EFI

Type mach. QUAD
Année-> 2009
->Année 2011
Oil/Oel : SO 6986
Air/Luft : SA 7534

800 R OUTLANDER EFI DPS

Type mach. QUAD
Année-> 2013
->Année 2014
Oil/Oel : SO 6986
Air/Luft : SA 7534

800 R OUTLANDER EFI XT

Type mach. QUAD
Année-> 2009
->Année 2011
Oil/Oel : SO 6986
Air/Luft : SA 7534

800 R OUTLANDER EFI XT

Type mach. QUAD
Année-> 2012
->Année 2014
Oil/Oel : SO 6986
Air/Luft : SA 7534

800 R OUTLANDER EFI XT-P

Type mach. QUAD
Année-> 2011
->Année 2014
Oil/Oel : SO 6986
Air/Luft : SA 7534

800 R OUTLANDER EFI XT-P

Type mach. QUAD
Année-> 2011
->Année 2012
Oil/Oel : SO 6986
Air/Luft : SA 7534

800 R OUTLANDER MAX EFI

Type mach. QUAD
Année-> 2009
Oil/Oel : SO 6986
Air/Luft : SA 7534

800 R OUTLANDER MAX EFI DPS

Type mach. QUAD
Année-> 2013
->Année 2014
Oil/Oel : SO 6986
Air/Luft : SA 7534

800 R OUTLANDER MAX EFI LTD

Type mach. QUAD
Année-> 2009
->Année 2012
Oil/Oel : SO 6986
Air/Luft : SA 7534

800 R OUTLANDER MAX EFI XT

Type mach. QUAD
Année-> 2009
->Année 2012
Oil/Oel : SO 6986
Air/Luft : SA 7534

QUADS | ATV | QUADS

BOMBARDIER

800 R OUTLANDER MAX EFI XT-P

Type mach. QUAD
Année-> 2013
->Année 2014
Oil/Oel : SO 6986
Air/Luft : SA 7534

800 R RENEGADE EFI

Type mach. QUAD
Année-> 2009
->Année 2013
Oil/Oel : SO 6986

800 R RENEGADE EFI X

Type mach. QUAD
Année-> 2012
Oil/Oel : SO 6986

800 R RENEGADE EFI X XC

Type mach. QUAD
Année-> 2012
Oil/Oel : SO 6986

800 RENEGADE

Type mach. QUAD
Année-> 2008
->Année 2009
Oil/Oel : SO 6986

800 RENEGADE X

Type mach. QUAD
Année-> 2008
->Année 2009
Oil/Oel : SO 6986

800 RENEGADE 4X4

Type mach. QUAD
Année-> 2006
Oil/Oel : SO 6986
Ess/Be : BE 215

BRP

VOIR/SEE/SIEHE BOMBARDIER

Type mach. .

CAN-AM

VOIR/SEE/SIEHE BOMBARDIER

Type mach. .

CANNONDALE

440

Type mach. QUAD
Oil/Oel : SO 6945

CECTECK

500 GLADIATOR EFI

Type mach. QUAD
Air/Luft : HR 7544

500 KINGCOBRA EFI

Type mach. QUAD
Air/Luft : HR 7544

CECTECK

500 QUADRIFT EFI

Type mach. QUAD
Air/Luft : HR 7544

CF MOTO

VOIR AUSSI/SEE/SIEHE DINLI

Type mach. .

CF 800-2

Type mach. QUAD
Oil/Oel : SO 6986

DELTA MICS

260

Type mach. QUAD
Année-> 2005

DELTA ALLIS

300 DA

Type mach. QUAD
Année-> 2004
Mot.make SUZUKI
Oil/Oel : SO 6988

400 DA A

Type mach. QUAD
Année-> 2004
Mot.make SUZUKI
Oil/Oel : SO 6988

500 DA MRP/TBX/TRV

Type mach. QUAD
Année-> 2004
Mot.make SUZUKI
Oil/Oel : SO 6999

DINLI

CF 500 4X4

Type mach. QUAD
Oil/Oel : T 501

DL 502-50 CC

Type mach. QUAD

DL 603-150 CC

Type mach. QUAD

DL 801-300 CC

Type mach. QUAD

DL 901-450 CC

Type mach. QUAD

270 DMX

Type mach. QUAD
Année-> 2005
Type carr. DL 901
Air/Luft : SA 8989

DINLI

450 DMX

Type mach. QUAD
Année-> 2005
Type carr. DL 901
Air/Luft : SA 8989

500 CF 118

Type mach. QUAD
Oil/Oel : T 501

500 CF-3

Type mach. QUAD
Oil/Oel : T 501

500 CF-5/5A

Type mach. QUAD
Oil/Oel : T 501

GAS GAS

240 HP WILD

Type mach. QUAD
Année-> 2005
Air/Luft : SA 8982

300 HP WILD

Type mach. QUAD
Année-> 2005
Air/Luft : SA 8982

450 HP WILD

Type mach. QUAD
Année-> 2004
Oil/Oel : SO 6994
Air/Luft : SA 8982

GILERA

250 OREGON

Type mach. QUAD
Année-> 2007
->Année 2008
Oil/Oel : SO 6967

GOES

220

Type mach. QUAD
Année-> 2005
Air/Luft : SA 8989

500 CF

Type mach. QUAD
Oil/Oel : T 501
Air/Luft : SA 7545

520 MAX

Type mach. QUAD
Oil/Oel : T 501
Air/Luft : SA 7545

525

Type mach. QUAD
Oil/Oel : T 501
Air/Luft : SA 7545

GOES

625
 Type mach. QUAD
 Oil/Oel : T 501
 Air/Luft : SA 7545

HONDA MOTO

200 TRX
 Type mach. QUAD

250 ATC ES BIG RED
 Type mach. QUAD
 Année-> 1985
 ->Année 1987
 Oil/Oel : SO 6994

250 R FOURTRAX
 Type mach. QUAD
 Année-> 1986
 ->Année 1989
 Oil/Oel : SO 6994
 Air/Luft : SA 8981

250 TRX EX
 Type mach. QUAD
 Année-> 1989
 ->Année 2000
 Oil/Oel : SO 6994
 Air/Luft : SA 8981

250 TRX EX
 Type mach. QUAD
 Année-> 2001
 ->Année 2006
 Oil/Oel : SO 6994
 Air/Luft : SA 8980

250 TRX R FOURTRAC

Type mach. QUAD
 Année-> 1986
 ->Année 1990
 Oil/Oel : SO 6994
 Air/Luft : SA 8981

250 TRX RECON
 Type mach. QUAD
 Année-> 1997
 ->Année 2001
 Oil/Oel : SO 6994
 Air/Luft : SA 8981

250 TRX RECON
 Type mach. QUAD
 Année-> 2002
 ->Année 2006
 Oil/Oel : SO 6994
 Air/Luft : SA 8980

250 TRX X
 Type mach. QUAD
 Année-> 2009

300 TRX
 Type mach. QUAD
 Année-> 1988
 ->Année 2001
 Oil/Oel : SO 6994
 Air/Luft : SA 8984

HONDA MOTO

300 TRX EX
 Type mach. QUAD
 Année-> 1993
 ->Année 2005
 Oil/Oel : SO 6994
 Air/Luft : SA 8984

300 TRX FW
 Type mach. QUAD
 Année-> 1990
 Oil/Oel : SO 6994
 Air/Luft : SA 8984

300 TRX X-9
 Type mach. QUAD
 Année-> 2009

300 TRX 4X4
 Type mach. QUAD
 ->Année 1999

330 RANCHER ES
 Type mach. QUAD
 Année-> 2003
 Oil/Oel : SO 6994

350 FOURTRAX ES 4X4
 Type mach. QUAD
 Année-> 2002
 Oil/Oel : SO 6994

350 TRX
 Type mach. QUAD
 Année-> 1986
 ->Année 1989
 Oil/Oel : SO 6994

350 TRX D FOREMAN
 Type mach. QUAD
 Année-> 1987
 ->Année 1989
 Oil/Oel : SO 6994

350 TRX EX SPORTRAX
 Type mach. QUAD
 Année-> 2002
 Oil/Oel : SO 6994

350 TRX FE RANCHER 4X4 ES
 Type mach. QUAD
 Année-> 2000
 ->Année 2006
 Oil/Oel : SO 6994

350 TRX FM RANCHER 4X4
 Type mach. QUAD
 Année-> 2000
 ->Année 2006
 Oil/Oel : SO 6994

350 TRX TE RANCHER ES
 Type mach. QUAD
 Année-> 2000
 ->Année 2006
 Oil/Oel : SO 6994

350 TRX TM RANCHER
 Type mach. QUAD
 Année-> 2000
 ->Année 2006
 Oil/Oel : SO 6994

HONDA MOTO

350 TRX 4X4
 Type mach. QUAD
 Année-> 2001
 Oil/Oel : SO 6994

400 FOREMAN S 4X4
 Type mach. QUAD
 Année-> 2003
 Oil/Oel : SO 6994

400 FOURTRAX ES/AT
 Type mach. QUAD
 Année-> 2002
 Oil/Oel : SO 6994

400 SPORTRAX EX
 Type mach. QUAD
 Année-> 1999
 Oil/Oel : SO 6994

400 TRX ES/EX/FM/FW
 Type mach. QUAD
 Année-> 1995
 ->Année 2003
 Oil/Oel : SO 6994
 Air/Luft : SA 8979

400 TRX EX
 Type mach. QUAD
 Année-> 1999
 ->Année 2000
 Oil/Oel : SO 6994

400 TRX FA FOURTRAX RANCHER AT
 Type mach. QUAD
 Année-> 2007
 Oil/Oel : SO 6993

400 TRX FA FOURTRAX RANCHER AT
 Type mach. QUAD
 Année-> 2004
 ->Année 2006
 Oil/Oel : SO 6993

400 TRX FGA FOURTRAX RANCHER
 Type mach. QUAD
 Année-> 2007
 Oil/Oel : SO 6993

400 TRX FGA FOURTRAX RANCHER AT
 Type mach. QUAD
 Année-> 2004
 ->Année 2006
 Oil/Oel : SO 6993

400 TRX FW FOREMAN 4X4
 Type mach. QUAD
 Année-> 1992
 ->Année 2003
 Oil/Oel : SO 6994

400 TRX X-9
 Type mach. QUAD
 Année-> 2009

420 TRX FM FOURTRAX RANCHER 4X4
 Type mach. QUAD
 Année-> 2007
 ->Année 2018
 Oil/Oel : SO 6994
 Air/Luft : SA 7548



HONDA MOTO

420 TRX FOURTRAX RANCHER

Type mach. QUAD
Année-> 2007
->Année 2018
Type carr. TM
Oil/Oel : SO 6929
Air/Luft : SA 7548

420 TRX FOURTRAX RANCHER AT

Type mach. QUAD
Année-> 2009
->Année 2018
Type carr. FA
Oil/Oel : SO 6929
Air/Luft : SA 7548

420 TRX FOURTRAX RANCHER AT

Type mach. QUAD
Année-> 2009
->Année 2014
Type carr. FPA
Oil/Oel : SO 6929
Air/Luft : SA 7548

420 TRX FOURTRAX RANCHER 4X4

Type mach. QUAD
Année-> 2007
->Année 2018
Type carr. FE
Oil/Oel : SO 6929
Air/Luft : SA 7548

420 TRX FOURTRAX RANCHER 4X4

Type mach. QUAD
Année-> 2009
->Année 2014
Type carr. FPM
Oil/Oel : SO 6929
Air/Luft : SA 7548

420 TRX FOURTRAX RANCHER 4X4 ES

Type mach. QUAD
Année-> 2009
->Année 2013
Type carr. FPE
Oil/Oel : SO 6929
Air/Luft : SA 7548

420 TRX TE FOURTRAX RANCHER ES

Type mach. QUAD
Année-> 2007
->Année 2016
Oil/Oel : SO 6994
Air/Luft : SA 7548

450 TRX

Type mach. QUAD
Année-> 2004
->Année 2005
Oil/Oel : SO 6980

450 TRX ER

Type mach. QUAD
Année-> 2006
->Année 2014
Oil/Oel : SO 6980

450 TRX FE FORMAN ES

Type mach. QUAD
Année-> 2002
->Année 2003
Oil/Oel : SO 6994

HONDA MOTO

450 TRX FM FORMAN S

Type mach. QUAD
Année-> 2002
->Année 2004

Oil/Oel : SO 6994

450 TRX FOURTRAX RANCHER AT

Type mach. QUAD
Année-> 2009
->Année 2016
Type carr. ER-9
Oil/Oel : SO 6929

450 TRX FW FORMAN 4X4

Type mach. QUAD
Année-> 1992
->Année 2003
Oil/Oel : SO 6994

450 TRX R

Type mach. QUAD
Année-> 2006
->Année 2009
Oil/Oel : SO 6980

450 TRX R

Type mach. QUAD
Année-> 2004
->Année 2005
Oil/Oel : SO 6980

450 TRX R 4X4

Type mach. QUAD
Année-> 2004
->Année 2005
Oil/Oel : SO 6980
Air/Luft : SA 8978

500 FOURTRAX ES/H

Type mach. QUAD
Année-> 2002

500 TRX FA FOREMAN

Type mach. QUAD
Année-> 2000
->Année 2007
Oil/Oel : SO 6993
Air/Luft : SA 7548

500 TRX FA FOURTAX

Type mach. QUAD
Année-> 2000
->Année 2007
Oil/Oel : SO 6993
Air/Luft : SA 7548

500 TRX FA FOURTRAX

Type mach. QUAD
Année-> 2015
->Année 2016
Oil/Oel : SO 6929
Air/Luft : SA 7548

500 TRX FA RUBICON

Type mach. QUAD
Année-> 2000
->Année 2007
Oil/Oel : SO 6993
Air/Luft : SA 7548

HONDA MOTO

500 TRX FA RUBICON

Type mach. QUAD
Année-> 2008
->Année 2011
Oil/Oel : SO 6993
Air/Luft : SA 7548

500 TRX FA RUBICON

Type mach. QUAD
Année-> 2012
->Année 2014
Oil/Oel : SO 6993
Air/Luft : SA 7548

500 TRX FE FOREMAN 4X4 ES

Type mach. QUAD
Année-> 2005
->Année 2014
Oil/Oel : SO 6994
Air/Luft : SA 7548

500 TRX FGA FOREMAN

Type mach. QUAD
Année-> 2004
->Année 2007
Oil/Oel : SO 6993
Air/Luft : SA 7548

500 TRX FGA FOURTRAX

Type mach. QUAD
Année-> 2004
->Année 2007
Oil/Oel : SO 6993
Air/Luft : SA 7548

500 TRX FGA RUBICON

Type mach. QUAD
Année-> 2004
->Année 2007
Oil/Oel : SO 6993
Air/Luft : SA 7548

500 TRX FM FOREMAN 4X4

Type mach. QUAD
Année-> 2005
->Année 2011
Oil/Oel : SO 6994
Air/Luft : SA 7548

500 TRX FM FOREMAN 4X4

Type mach. QUAD
Année-> 2012
->Année 2014
Oil/Oel : SO 6994
Air/Luft : SA 7548

500 TRX FOREMAN

Type mach. QUAD
Année-> 2009
Type carr. FA-9
Air/Luft : SA 7548

500 TRX FOREMAN

Type mach. QUAD
Année-> 2015
->Année 2016
Oil/Oel : SO 6929
Air/Luft : SA 7548

500 TRX FOURTRAX

Type mach. QUAD
Année-> 2009
Type carr. FA-9
Air/Luft : SA 7548

HONDA MOTO		HONDA MOTO		HYTRACK	
500 TRX FOURTRAX EPS		650 TRX FA FOURTRAX RINCON		HY 260	
Type mach.	QUAD	Type mach.	QUAD	Type mach.	QUAD
Année->	2009	Année->	2003	Air/Luft :	SA 28995
Type carr.	FPA-9	->Année	2005	Air/Luft :	SA 8995
Air/Luft :	SA 7548	Oil/Oel :	SO 6993		PREF/VORF
500 TRX FOURTRAX FOREMAN 4X4		650 TRX FGA FOURTRAX RINCON		HY 265 H	
Type mach.	QUAD	Type mach.	QUAD	Type mach.	QUAD
Année->	2009	Année->	2004	Année->	2003
Type carr.	FM-9	->Année	2005	Air/Luft :	SA 28995
Air/Luft :	SA 7548	Oil/Oel :	SO 6993	Air/Luft :	SA 8995
500 TRX FOURTRAX FOREMAN 4X4 ES		680 TRX FA FOURTRAX RINCON		HY 265 6X6	
Type mach.	QUAD	Type mach.	QUAD	Type mach.	QUAD
Année->	2009	Année->	2006	Année->	2004
Type carr.	FPE-9	->Année	2008	Air/Luft :	SA 28995
Air/Luft :	SA 7548	Type carr.	FA6->FA8	Air/Luft :	SA 8995
500 TRX FOURTRAX FOREMAN 4X4 ES		680 TRX FGA FOURTRAX RINCON		HY 300 4X4	
Type mach.	QUAD	Type mach.	QUAD	Type mach.	QUAD
Année->	2009	Année->	2009	Année->	2004
Type carr.	FPM-9	->Année	2014	Air/Luft :	SA 28995
Air/Luft :	SA 7548	Oil/Oel :	SO 6993	Air/Luft :	SA 8995
500 TRX FOURTRAX FOREMAN 4X4 ES		700 TRX		HY 400	
Type mach.	QUAD	Type mach.	QUAD	Type mach.	QUAD
Année->	2009	Année->	2009	Air/Luft :	SA 8995
Type carr.	FE-9	->Année	2014	HY 420	
Air/Luft :	SA 7548	Oil/Oel :	SO 6993	Type mach.	QUAD
500 TRX FPA FOREMAN RUBICON		90 SPORTRAX		HY 500	
GPSCAPE W/EPS		Type mach.		QUAD	
Type mach.	QUAD	Année->		2006	
Année->	2009	->Année		2008	
->Année	2014	Type carr.		FGA6->FGA8	
Oil/Oel :	SO 6993	Oil/Oel :		SO 6993	
Air/Luft :	SA 7548	680 TRX FOURTRAX RINCON		HY 510 S	
500 TRX FPE FOREMAN 4X4 W/PS		Type mach.		QUAD	
Type mach.	QUAD	Année->		2009	
Année->	2007	Type carr.		FA-9	
->Année	2014	700 TRX		HY 550 4X4	
Oil/Oel :	SO 6994	Type mach.		QUAD	
Air/Luft :	SA 7548	Année->		2009	
500 TRX FPM FOREMAN 4X4 W/PS		Type carr.		XX-9	
Type mach.	QUAD	Oil/Oel :		SO 6994	
Année->	2008	90 SPORTRAX		HY 560	
->Année	2014	Type mach.		QUAD	
Oil/Oel :	SO 6994	Année->		2002	
Air/Luft :	SA 7548	HUSQVARNA		HY 600	
500 TRX RUBICON		450 QM		HY 700	
Type mach.	QUAD	Type mach.		QUAD	
Année->	2009	Année->		2007	
Type carr.	FA-9	->Année		2008	
Air/Luft :	SA 7548	Oil/Oel :		SO 7162	
500 TRX RUBICON		Oil/Oel :		SO 6948	
Type mach.	QUAD	SANS/OHNE BY-PASS		OU	
Année->	2015	AVEC/MIT BY-PASS			
->Année	2016	HYOSUNG		710 S	
Oil/Oel :	SO 6929	450 TE		Type mach.	
500 TRX TM FOREMAN		Type mach.		QUAD	
Type mach.	QUAD	Année->		2008	
Année->	2005	->Année		2011	
->Année	2006	Oil/Oel :		T 501	
Oil/Oel :	SO 6994				
Air/Luft :	SA 7548				



JOHN DEERE		KAWASAKI MOTO		KAWASAKI MOTO	
500 BUCK		250 KLF BAYOU		300 KLF BAYOU	
Type mach.	QUAD	Type mach.	QUAD	Type mach.	QUAD
Année->	2005	Année->	2003	Année->	1986
Oil/Oel :	SO 6983	->Année	2009	->Année	1987
Air/Luft :	SA 8984	Type carr.	A1-A3/A6-9F	Type carr.	A1/A2
500 EX BUCK		Oil/Oel :	SO 6995	Oil/Oel :	SO 6995
Type mach.	QUAD	250 KLF BAYOU		300 KLF BAYOU	
Année->	2005	Type mach.	QUAD	Type mach.	QUAD
Oil/Oel :	SO 6983	Année->	2010	Année->	1988
Air/Luft :	SA 8984	->Année	2011	->Année	2004
500 EXT BUCK		Oil/Oel :	SO 6995	Type carr.	B1->B17
Type mach.	QUAD	250 KLT		Oil/Oel :	SO 6995
Année->	2005	Type mach.	ATC	Air/Luft :	SA 12317
Oil/Oel :	SO 6983	Année->	1982	300 KLF BAYOU 4X4	
Air/Luft :	SA 8984	->Année	1983	Type mach.	QUAD
500 TRAIL BUCK		Type carr.	A1/A2	Année->	1996
Type mach.	QUAD	Oil/Oel :	SO 6995	->Année	1997
Année->	2005	250 KLT PRAIRIE		Type carr.	A8/A9
Oil/Oel :	SO 6983	Type mach.	ATC	Oil/Oel :	SO 6995
Air/Luft :	SA 8984	Année->	1983	Air/Luft :	SA 12317
650 EX TRAIL BUCK		->Année	1985	300 KLF MULE 520/550	
Type mach.	QUAD	Type carr.	C1/C2/C3	Type mach.	QUAD
Année->	2005	Oil/Oel :	SO 6995	Année->	1997
Oil/Oel :	SO 6986	250 KLT P1		Oil/Oel :	T 1636
Air/Luft :	SA 8984	Type mach.	ATC	300 KVF PRAIRIE 2X4	
650 EXT TRAIL BUCK		Année->	1984	Type mach.	QUAD
Type mach.	QUAD	Oil/Oel :	SO 6995	Année->	1999
Année->	2005	250 KSF MOJAVE		->Année	2002
Oil/Oel :	SO 6986	Type mach.	QUAD	Oil/Oel :	T 59
Air/Luft :	SA 8984	Année->	1987	Air/Luft :	SA 12317
650 TRAIL BUCK		->Année	1990	300 KVF PRAIRIE 4X4	
Type mach.	QUAD	Type carr.	A1-A4	Type mach.	QUAD
Année->	2005	Oil/Oel :	SO 6995	Année->	1999
Oil/Oel :	SO 6986	250 KSF MOJAVE		->Année	2002
Air/Luft :	SA 8984	Type mach.	QUAD	Oil/Oel :	T 59
KAWASAKI MOTO					
200 KLT		Année->	1991	Air/Luft :	SA 12317
Type mach.	ATC	->Année	2004	300 PRAIRIE	
Année->	1983	Type carr.	A5-A18	Type mach.	QUAD
->Année	1984	Oil/Oel :	SO 6995	Année->	2002
Type carr.	C1/C2	250 MOJAVE		Oil/Oel :	T 59
Oil/Oel :	SO 6995	Type mach.	QUAD	360 KVF KL	
200 KLT		Année->	2002	Type mach.	QUAD
Type mach.	ATC	Oil/Oel :	SO 6995	Année->	2005
Année->	1980	300 KEF LAKOTA		Air/Luft :	SA 8976
->Année	1983	Type mach.	QUAD	360 KVF PRAIRIE 4X4	
Type carr.	A-A4/A4A/B1	Année->	1995	Type mach.	QUAD
Oil/Oel :	SO 6995	->Année	2000	Année->	2002
220 KLF BAYOU		Type carr.	A1-A6	Oil/Oel :	T 59
Type mach.	QUAD	Oil/Oel :	SO 6995	Air/Luft :	SA 8976
Année->	1988	300 KEF LAKOTA		360 KVF PRAIRIE 4X4	
->Année	2002	Type mach.	QUAD	Type mach.	QUAD
Type carr.	A1-A15	Année->	2001	Année->	2008
Oil/Oel :	SO 6995	->Année	2003	->Année	2009
Air/Luft :	SA 12317	Type carr.	B1-B3	Type carr.	AB8/9F
250 KLF BAYOU					
Type mach.	QUAD	Oil/Oel :	SO 6995	Oil/Oel :	T 59
Année->	1989	300 KLF BAYOU		Air/Luft :	SA 8976
->Année	2004	Type mach.	QUAD	360 KVF PRAIRIE 4X4	
Type carr.	C1->C16	Année->	1989	Type mach.	QUAD
Oil/Oel :	SO 6995	->Année	2004	Année->	2010
Air/Luft :	SA 12317	Type carr.	C1->C16	->Année	2013
250 KLF BAYOU					
Type mach.	QUAD	Oil/Oel :	SO 6995	Oil/Oel :	T 59
Année->	1988	Air/Luft :	SA 12317	Air/Luft :	SA 8976
->Année	2004	300 KLF BAYOU		360 KVF PRAIRIE 4X4	
Type carr.	C1->C16	Type mach.	QUAD	Type mach.	QUAD
Oil/Oel :	SO 6995	Année->	1989	Année->	2010
Air/Luft :	SA 12317	->Année	2004	->Année	2013
250 KLF BAYOU					
Type mach.	QUAD	Type carr.	C1->C16	Oil/Oel :	T 59
Année->	1988	Oil/Oel :	SO 6995	Air/Luft :	SA 8976
->Année	2004	300 KLF BAYOU		360 KVF PRAIRIE 4X4	
Type carr.	B1->B17	Type mach.	QUAD	Type mach.	QUAD
Oil/Oel :	SO 6995	Année->	1989	Année->	2010
Air/Luft :	SA 12317	->Année	2004	->Année	2013
250 KLF BAYOU					
Type mach.	QUAD	Type carr.	C1->C16	Oil/Oel :	T 59
Année->	1988	Oil/Oel :	SO 6995	Air/Luft :	SA 8976
->Année	2004	300 KLF BAYOU		360 KVF PRAIRIE 4X4	
Type carr.	A8/A9	Type mach.	QUAD	Type mach.	QUAD
Oil/Oel :	SO 6995	Année->	1989	Année->	2010
Air/Luft :	SA 12317	->Année	2004	->Année	2013
250 KLF BAYOU					
Type mach.	QUAD	Type carr.	C1->C16	Oil/Oel :	T 59
Année->	1988	Oil/Oel :	SO 6995	Air/Luft :	SA 8976
->Année	2004	300 KLF BAYOU		360 KVF PRAIRIE 4X4	
Type carr.	A8/A9	Type mach.	QUAD	Type mach.	QUAD
Oil/Oel :	SO 6995	Année->	1989	Année->	2010
Air/Luft :	SA 12317	->Année	2004	->Année	2013
250 KLF BAYOU					
Type mach.	QUAD	Type carr.	C1->C16	Oil/Oel :	T 59
Année->	1988	Oil/Oel :	SO 6995	Air/Luft :	SA 8976
->Année	2004	300 KLF BAYOU		360 KVF PRAIRIE 4X4	
Type carr.	A8/A9	Type mach.	QUAD	Type mach.	QUAD
Oil/Oel :	SO 6995	Année->	1989	Année->	2010
Air/Luft :	SA 12317	->Année	2004	->Année	2013

KAWASAKI MOTO

360 KVF PRAIRIE 4X4 HARD.GREEN

Type mach. QUAD
Année-> 2004
->Année 2011
Type carr. C8/9F
Oil/Oel : T 59
Air/Luft : SA 8976

400 KAF MULE 610 4X4

Type mach. QUAD
Année-> 2005
Oil/Oel : T 1636
Air/Luft : SA 12317

400 KFX

Type mach. QUAD
Année-> 2003
Oil/Oel : T 59
Air/Luft : SA 8975

400 KFX/KSF

Type mach. QUAD
Année-> 2005
->Année 2006
Type carr. A1/A3/A6F
Oil/Oel : SO 6979

400 KLF BAYOU 4X4

Type mach. QUAD
Année-> 1993
->Année 1999
Oil/Oel : T 59
Air/Luft : SA 12317

400 KVF PRAIRIE 2X4

Type mach. QUAD
Année-> 1998
->Année 2002
Oil/Oel : T 59
Air/Luft : SA 12317

400 KVF PRAIRIE 4X4

Type mach. QUAD
Année-> 1998
->Année 2002
Oil/Oel : T 59
Air/Luft : SA 12317

450 KFX R

Type mach. QUAD
Année-> 2008
->Année 2014
Oil/Oel : SO 6994

450 KFX R

Type mach. QUAD
Année-> 2008
->Année 2014
Type carr. B8F/9F/AF/BF/CS
Oil/Oel : SO 6994

650 KFX PRAIRIE 4X4

Type mach. QUAD
Année-> 2003
Air/Luft : SA 8974

650 KVF

Type mach. QUAD
Année-> 2002
Oil/Oel : T 59
Air/Luft : SA 8974

KAWASAKI MOTO

650 KVF BRUTE FORCE 4X4

Type mach. QUAD
Année-> 2005
Oil/Oel : T 59
Air/Luft : SA 8974

650 KVF BRUTE FORCE 4X4

Type mach. QUAD
Année-> 2008
->Année 2009
Type carr. D8/9F
Oil/Oel : T 59

650 KVF BRUTE FORCE 4X4

Type mach. QUAD
Année-> 2008
->Année 2009
Type carr. E8/9F
Oil/Oel : T 59

650 KVF BRUTE FORCE 4X4 I

Type mach. QUAD
Année-> 2008
->Année 2009
Type carr. F8/9F
Oil/Oel : T 59

650 KVF PRAIRIE 4X4

Type mach. QUAD
Année-> 2003
Oil/Oel : T 59
Air/Luft : SA 8974

700 KFX

Type mach. QUAD
Année-> 2008
->Année 2009
Type carr. A8/9F
Oil/Oel : T 59

700 KFX

Type mach. QUAD
Année-> 2008
->Année 2009
Type carr. B8/9F
Oil/Oel : T 59

700 KFX PRAIRIE 4X4

Type mach. QUAD
Année-> 2003
Air/Luft : SA 8974

700 KFX SPECIAL EDITION

Type mach. QUAD
Année-> 2005
Air/Luft : SA 8974

700 KFX V FORCE

Type mach. QUAD
Année-> 2003
Air/Luft : SA 8974

700 KFX 4X4

Type mach. QUAD
Année-> 2003
Air/Luft : SA 8974

700 KVF PRAIRIE 4X4 HARDWOODS GREEN HD

Type mach. QUAD
Année-> 2004
->Année 2005
Oil/Oel : SO 6955
Air/Luft : SA 8974

KAWASAKI MOTO

700 KVF TEAM GREEN SPECIAL EDITION

Type mach. QUAD
Année-> 2005
->Année 2006
Oil/Oel : SO 6955
Air/Luft : SA 8974

700 KVF 4X4

Type mach. QUAD
Année-> 2004
Oil/Oel : T 59
Air/Luft : SA 8974

750 KVF BRUTE FORCE

Type mach. QUAD
Année-> 2003
Oil/Oel : T 59
Air/Luft : SA 8973

750 KVF BRUTE FORCE 4X4 I

Type mach. QUAD
Année-> 2008
->Année 2014
Oil/Oel : SO 6955

750 KVF BRUTE FORCE 4X4 I

Type mach. QUAD
Année-> 2005
->Année 2007
Oil/Oel : SO 6955

750 KVF BRUTE FORCE 4X4I

Type mach. QUAD
Année-> 2008
Type carr. E8/9F
Oil/Oel : T 59

750 KVF BRUTE FORCE 4X4I NRA

Type mach. QUAD
Année-> 2008
Type carr. E8/9FA
Oil/Oel : T 59

750 KVF BRUTE FORCE 4X4I NRA

Type mach. QUAD
Année-> 2008
->Année 2009
Type carr. D8/9FA
Oil/Oel : T 59

750 KVF REALTREE HARD.GREEN

Type mach. QUAD
Année-> 2008
Type carr. E8/9F
Oil/Oel : T 59

KTM

450 SX ATV

Type mach. QUAD
Année-> 2009
->Année 2011
Air/Luft : SA 7808

450 XC ATV

Type mach. QUAD
Année-> 2008
->Année 2011
Oil/Oel : SO 7095
Oil/Oel : SO 6985
Air/Luft : SA 7808

QUADS | ATV | QUADS

KTM

505 SX ATV

Type mach. QUAD
Année-> 2009
->Année 2011
Air/Luft : SA 7808

525 XC ATV

Type mach. QUAD
Année-> 2008
->Année 2011
Oil/Oel : SO 7095
Oil/Oel : SO 6985
Air/Luft : SA 7808

KYMCO

150 MXU

Type mach. QUAD
Année-> 2005

250 KXR

Type mach. QUAD
Année-> 2003
Air/Luft : SA 8972

250 MXU

Type mach. QUAD
Année-> 2004
Air/Luft : SA 8972

250 URBAN QUAD

Type mach. QUAD
Année-> 2004
Air/Luft : SA 8972

300 MAXXER

Type mach. QUAD
Année-> 2005
Air/Luft : SA 8972

300 MXU

Type mach. QUAD
Année-> 2005
Air/Luft : SA 8972

375 MXU

Type mach. QUAD
Année-> 2009
->Année 2013
Oil/Oel : SO 6999

400 MAXXER

Type mach. QUAD
Oil/Oel : SO 6999

400 MXU

Type mach. QUAD
Oil/Oel : SO 6999
Air/Luft : SA 7940

450 MAXXER

Type mach. QUAD
Année-> 2011
->Année 2014
Oil/Oel : SO 6999

450 MXU

Type mach. QUAD
Année-> 2011
->Année 2014
Oil/Oel : SO 6999

KYMCO

50 MAXXER

Type mach. QUAD
Année-> 2005

50 MXU

Type mach. QUAD
Année-> 2005

500 MXU

Type mach. QUAD
Année-> 2005
Oil/Oel : SO 6969

500 MXU

Type mach. QUAD
Année-> 2006
->Année 2008
Oil/Oel : SO 6969

500 MXU

Type mach. QUAD
Année-> 2009
->Année 2014
Oil/Oel : SO 6969

500 UXV

Type mach. QUAD
Année-> 2009
->Année 2014
Oil/Oel : SO 6969

550 MXU

Type mach. QUAD
Année-> 2011
->Année 2012
Oil/Oel : SO 6969

700 MXU

Type mach. QUAD
Année-> 2013
Oil/Oel : SO 6969

90 MAXXER

Type mach. QUAD
Année-> 2006

LINHAI

260 LH/H

Type mach. QUAD
Année-> 2004
Air/Luft : SA 8971

260 YETI

Type mach. QUAD
Année-> 2004
Air/Luft : SA 8971

MASAI

S 800 I

Type mach. QUAD
Oil/Oel : T 600

S 900 CROSSOVER

Type mach. QUAD
Oil/Oel : SO 6986

MASAI

700 CENTHOR

Type mach. QUAD
Oil/Oel : T 59

MASSEY FERGUSON

MF 250/2

Type mach. QUAD
Année-> 2002
Oil/Oel : SO 6988

MF 400

Type mach. QUAD
Année-> 2005
Oil/Oel : SO 6999
Air/Luft : SA 8991

MF 400/4

Type mach. QUAD
Année-> 2002
Oil/Oel : SO 6999
Air/Luft : SA 8991

MF 500 AUTO/TBX/4

Type mach. QUAD
Année-> 2002
Oil/Oel : SO 6999
Air/Luft : SA 8991

MF 500 AUTO/4

Type mach. QUAD
Année-> 2002
Oil/Oel : SO 6999
Air/Luft : SA 8991

MF 500/4

Type mach. QUAD
Année-> 2002
Oil/Oel : SO 6999
Air/Luft : SA 8991

MF 650 H/D

Type mach. QUAD
Année-> 2005

MF 700 D

Type mach. QUAD
Année-> 2005

MINICO

300 PUMA

Type mach. QUAD
Année-> 2004
Air/Luft : SA 8971

550 PUMA

Type mach. QUAD
Oil/Oel : T 501

POLARIS

RANGER

Type mach. QUAD
 Mot.make YANMAR
 Mot.type 3TNM72
 Mot.energ. DIESEL
 Oil/Oel : T 600
 Gasoil : SN 21581 *PREF/VORF*
 Gasoil : SN 25027

RANGER DIESEL

Type mach. TRANSPORTEUR
 Année-> 2015
 Mot.make KOHLER
 Oil/Oel : SO 8148
 Gasoil : SN 40772
 Air/Luft : SA 7555

RANGER HST DELUX

Type mach. TRANSPORTEUR
 Année-> 2016
 Mot.make KOHLER
 Oil/Oel : SO 8148
 Gasoil : SN 40772
 Air/Luft : SA 16074

1000 SCRAMBLER HP HO EPS

Type mach. QUAD
 Année-> 2014
 ->Année 2015
 Oil/Oel : T 59
 Air/Luft : SA 8995

1000 SCRAMBLER XP

Type mach. QUAD
 Année-> 2016
 Oil/Oel : T 59
 Air/Luft : SA 8995

1000 SPORTSMAN HL

Type mach. QUAD
 Année-> 2016
 Oil/Oel : T 59
 Air/Luft : SA 8995

1000 SPORTSMAN TOURING

Type mach. QUAD
 Année-> 2016
 Oil/Oel : T 59
 Air/Luft : SA 8995

1000 SPORTSMAN XP

Type mach. QUAD
 Année-> 2016
 Oil/Oel : T 59
 Air/Luft : SA 8995

1000 SPORTSMAN XP HUNTER EDITION

Type mach. QUAD
 Année-> 2018
 Oil/Oel : T 59
 Air/Luft : SA 8995

1000 SPORTSMAN XP TOURING

Type mach. QUAD
 Année-> 2017
 Oil/Oel : T 59
 Air/Luft : SA 8995

POLARIS

200 PHOENIX

Type mach. QUAD
 Année-> 2005
 Oil/Oel : SO 6967
 Air/Luft : SA 8994

200 SAWTOOTH

Type mach. QUAD
 Année-> 2006
 Air/Luft : SA 8994

250 TRAIL BLAZER

Type mach. QUAD
 Année-> 2001
 Air/Luft : SA 8994

250 TRAIL BOSS

Type mach. QUAD
 Année-> 1996
 ->Année 1999
 Air/Luft : SA 12123 *OVAL OU/ODER*
 Air/Luft : SA 12068 *ROND/ROUND*

250 TRAILBLAZER

Type mach. QUAD
 Année-> 1996
 ->Année 2000
 Air/Luft : SA 12123 *OVAL OU/ODER*
 Air/Luft : SA 12068 *ROND/ROUND*

250 XPLOREUR 4X4

Type mach. QUAD
 Année-> 2000
 Air/Luft : SA 12123 *OVAL OU/ODER*
 Air/Luft : SA 12068 *ROND/ROUND*

300 HAWKEYE 2X4

Type mach. QUAD
 Année-> 2006
 Oil/Oel : T 59
 Air/Luft : SA 8994

300 HAWKEYE 4X4

Type mach. QUAD
 Année-> 2006
 Oil/Oel : T 59
 Air/Luft : SA 8994

300 SPORTSMAN

Type mach. QUAD
 Année-> 2008
 ->Année 2009
 Oil/Oel : T 59
 Air/Luft : SA 8994

300 SPORTSMAN

Type mach. QUAD
 Année-> 2010
 Oil/Oel : T 59

300 TRAIL

Type mach. QUAD
 ->Année 1995
 Air/Luft : SA 12123 *OVAL OU/ODER*
 Air/Luft : SA 12068 *ROND/ROUND*

300 TRAIL 4X4

Type mach. QUAD
 ->Année 1995
 Air/Luft : SA 12123 *OVAL OU/ODER*
 Air/Luft : SA 12068 *ROND/ROUND*

POLARIS

300 XPLOREUR 4X4

Type mach. QUAD
 Année-> 1996
 ->Année 1999
 Air/Luft : SA 12123 *OVAL OU/ODER*
 Air/Luft : SA 12068 *ROND/ROUND*

300 XPRESS

Type mach. QUAD
 Année-> 1996
 ->Année 1999
 Air/Luft : SA 12123 *OVAL OU/ODER*
 Air/Luft : SA 12068 *ROND/ROUND*

325 ACE

Type mach. QUAD
 Année-> 2015
 ->Année 2016
 Oil/Oel : SO 6980

325 HAWKEYE 2X4

Type mach. QUAD
 Année-> 2015
 ->Année 2016
 Oil/Oel : T 59

325 HAWKEYE 4X4

Type mach. QUAD
 Année-> 2015
 ->Année 2016
 Oil/Oel : T 59

325 MAGNUM 2X4

Type mach. QUAD
 Année-> 2000
 ->Année 2001
 Air/Luft : SA 8995

325 MAGNUM 2X4/4X4

Type mach. QUAD
 Année-> 1994
 Oil/Oel : T 59
 Air/Luft : SA 8995

325 MAGNUM 2X4/4X4

Type mach. QUAD
 Année-> 2001
 ->Année 2002
 Oil/Oel : T 59
 Air/Luft : SA 8994

325 MAGNUM 4X4

Type mach. QUAD
 Année-> 2000
 ->Année 2001
 Air/Luft : SA 8995

325 SPORTSMAN ACE

Type mach. QUAD
 Année-> 2014
 ->Année 2015
 Oil/Oel : SO 6980

325 SPORTSMAN ETX

Type mach. QUAD
 Année-> 2014
 ->Année 2015
 Oil/Oel : SO 6980

325 TRAIL BOSS 2X4

Type mach. QUAD
 Année-> 2001
 ->Année 2002
 Air/Luft : SA 8994



QUADS | ATV | QUADS

POLARIS

325 TRAIL BOSS 4X4/4X2

Type mach. QUAD
 Année-> 2000
 ->Année 2001
 Oil/Oel : T 59
 Air/Luft : SA 8995

325 XPEDITION 4X4

Type mach. QUAD
 Année-> 2000
 ->Année 2002
 Oil/Oel : T 59
 Air/Luft : SA 8995

330 ATP

Type mach. QUAD
 Année-> 2004
 ->Année 2005
 Air/Luft : SA 8994

330 HAWKEYE 2X4/4X4

Type mach. QUAD
 Année-> 2015
 ->Année 2016
 Oil/Oel : T 59
 Air/Luft : SA 8994

330 MAGNUM

Type mach. QUAD
 Année-> 1999
 ->Année 2005
 Oil/Oel : T 59
 Air/Luft : SA 8994

330 MAGNUM 4X4

Type mach. QUAD
 Année-> 1999
 ->Année 2005
 Oil/Oel : T 59
 Air/Luft : SA 8994

330 TRAIL BLAZER

Type mach. QUAD
 Année-> 2008
 ->Année 2009
 Oil/Oel : T 59

330 TRAIL BLAZER

Type mach. QUAD
 Année-> 2010
 ->Année 2013
 Oil/Oel : T 59
 Air/Luft : SA 8995

330 TRAIL BOSS

Type mach. QUAD
 Année-> 2003
 ->Année 2009
 Oil/Oel : T 59
 Air/Luft : SA 8994

330 TRAIL BOSS

Type mach. QUAD
 Année-> 2010
 ->Année 2013
 Oil/Oel : T 59
 Air/Luft : SA 8995

330 TRAILBLAZER

Type mach. QUAD
 Année-> 2008
 ->Année 2009
 Oil/Oel : T 59

POLARIS

335 SPORTSMAN 4X4

Type mach. QUAD
 Année-> 1998
 ->Année 2001
 Oil/Oel : T 59
 Air/Luft : SA 8995

335 WORKER

Type mach. QUAD
 Année-> 1999
 ->Année 2001
 Oil/Oel : T 59
 Air/Luft : SA 8995

400 BIGBOSS 6X6

Type mach. QUAD
 Année-> 1996
 ->Année 1997
 Mot.make YANMAR
 Mot.type 400 CM3
 Gasoil : SN 24632
 Air/Luft : SA 12156

400 HAWKEYE HO 2X4

Type mach. QUAD
 Année-> 2011
 Oil/Oel : T 59

400 SCRAMBLER

Type mach. QUAD
 Année-> 2000
 Oil/Oel : T 59

400 SCRAMBLER 4X4

Type mach. QUAD
 Année-> 2000
 Oil/Oel : T 59

400 SPORTSMAN

Type mach. QUAD
 Année-> 2004
 Air/Luft : SA 8995

400 SPORTSMAN

Type mach. QUAD
 Année-> 1995
 ->Année 1996

Air/Luft : SA 12123

Air/Luft : SA 12068

OVAL OU/ODER
 ROND/ROUND

400 SPORTSMAN

Type mach. QUAD
 Année-> 2002
 Air/Luft : SA 8995

400 SPORTSMAN H.O

Type mach. QUAD
 Année-> 2008
 ->Année 2014
 Oil/Oel : T 59
 Air/Luft : SA 8995

400 SPORTSMAN 4X4

Type mach. QUAD
 Année-> 2001
 Oil/Oel : T 59
 Air/Luft : SA 28995
 Air/Luft : SA 8995

PREF/VORF

400 TRAIL

Type mach. QUAD
 ->Année 1995

POLARIS

400 TRAILBLAZER

Type mach. QUAD
 Année-> 2000
 Oil/Oel : T 59
 Air/Luft : SA 12123

400 XPLORES

Type mach. QUAD
 Année-> 1996
 ->Année 1998
 Air/Luft : SA 12123
 Air/Luft : SA 12068

OVAL OU/ODER
 ROND/ROUND

400 XPLOREUR 4X4

Type mach. QUAD
 Année-> 2001
 Oil/Oel : T 59
 Air/Luft : SA 8970

400 XPRESS

Type mach. QUAD
 ->Année 1997

425 MAGNUM

Type mach. QUAD
 Année-> 1994
 Oil/Oel : T 59

425 MAGNUM 4X4

Type mach. QUAD
 Année-> 1994
 Oil/Oel : T 59

425 XPEDITION 4X4

Type mach. QUAD
 Année-> 1999
 ->Année 2002
 Oil/Oel : T 59
 Air/Luft : SA 8995

430 RANGER

Type mach. QUAD
 Oil/Oel : T 59
 Air/Luft : SA 28995
 Air/Luft : SA 8995

PREF/VORF

450 OUTLAW MRX

Type mach. QUAD
 Année-> 2008
 ->Année 2009
 Oil/Oel : SO 7095
 Oil/Oel : SO 6985

+

450 SPORTSMAN

Type mach. QUAD
 Année-> 2006
 ->Année 2007
 Oil/Oel : T 59
 Air/Luft : SA 8995

450 SPORTSMAN H.O

Type mach. QUAD
 Année-> 2016
 Oil/Oel : T 59
 Air/Luft : SA 8995

450 SPORTSMAN H.O EPS

Type mach. QUAD
 Année-> 2017
 Oil/Oel : T 59
 Air/Luft : SA 8995

POLARIS		POLARIS		POLARIS	
450 SPORTSMAN 6X6		500 SCRAMBLER 2X4/4X4		500 SPORTSMAN 4X4	
Type mach.	QUAD	Type mach.	QUAD	Type mach.	QUAD
Année->	2007	Année->	1997	Année->	1996
Oil/Oel :	T 59	->Année	2009	->Année	2005
Air/Luft :	SA 8995	Oil/Oel :	T 59	Oil/Oel :	T 59
455 DIESEL 4X4		Air/Luft :	SA 28995	Air/Luft :	SA 28995
Type mach.	QUAD	Air/Luft :	SA 8995	Air/Luft :	SA 8995
Année->	1999	PREF/VORF		PREF/VORF	
Oil/Oel :	T 59	500 SPORTSMAN EFI		500 SPORTSMAN 6X6	
Air/Luft :	SA 8995	Type mach.	QUAD	Type mach.	QUAD
500 ATP HO		Année->	2006	Année->	2000
Type mach.	QUAD	->Année	2009	->Année	2004
Année->	2004	Oil/Oel :	T 59	Oil/Oel :	T 59
Oil/Oel :	T 59	Air/Luft :	SA 8995	Air/Luft :	SA 28995
Air/Luft :	SA 8995	500 SPORTSMAN EFI TOURING		Air/Luft :	SA 8995
500 BIGBOSS 6X6		Type mach.	QUAD	PREF/VORF	
Type mach.	QUAD	Année->	2008	500 WORKER	
Année->	1998	->Année	2009	Type mach.	QUAD
Oil/Oel :	T 59	Oil/Oel :	T 59	Année->	1999
Air/Luft :	SA 8995	500 SPORTSMAN FOREST		->Année	2001
500 MAGNUM 4X4		Type mach.	QUAD	Oil/Oel :	T 59
Type mach.	QUAD	Année->	2012	Air/Luft :	SA 8995
Année->	1999	->Année	2014	500 XPLOREUR 4X4	
->Année	2003	Oil/Oel :	T 59	Type mach.	QUAD
Mot.make	POLARIS	Air/Luft :	SA 8995	Année->	1997
Mot.type	EH 50 PLE 08	500 SPORTSMAN HO		Oil/Oel :	T 59
Oil/Oel :	T 59	Type mach.	QUAD	Air/Luft :	SA 8995
Gasoil :	SN 20106	Année->	2010	525 OUTLAW	
Air/Luft :	SA 28995	->Année	2013	Type mach.	QUAD
Air/Luft :	SA 8995	Oil/Oel :	T 59	Année->	2007
500 OUTLAW		Air/Luft :	SA 8995	->Année	2011
Type mach.	QUAD	500 SPORTSMAN HO TOURING		Oil/Oel :	SO 7095
Année->	2006	Type mach.	QUAD	Oil/Oel :	SO 6985
Oil/Oel :	SO 6994	Année->	2010	550 SPORTSMAN	
500 OUTLAW		->Année	2013	Type mach.	QUAD
Type mach.	QUAD	Oil/Oel :	T 59	Année->	2011
Année->	2007	Air/Luft :	SA 8995	->Année	2014
Oil/Oel :	SO 6994	500 SPORTSMAN HO/HO MOSSY OAK		Air/Luft :	SA 8995
500 PREDATOR		Type mach.	QUAD	Air/Luft :	SA 28995
Type mach.	QUAD	Année->	2000	PREF/VORF	
Année->	2003	->Année	2009	550 SPORTSMAN EPS	
->Année	2007	Oil/Oel :	T 59	Type mach.	QUAD
Oil/Oel :	SO 6994	Air/Luft :	SA 8995	Année->	2010
Air/Luft :	SA 8992	500 SPORTSMAN MOSSY OAK		->Année	2014
500 PREDATOR TROY LEE		Type mach.	QUAD	Air/Luft :	SA 8995
Type mach.	QUAD	Année->	2004	Air/Luft :	SA 28995
Année->	2005	Oil/Oel :	T 59	PREF/VORF	
Oil/Oel :	SO 6994	Air/Luft :	SA 8995	550 SPORTSMAN EPS BROWNING	
Air/Luft :	SA 8992	500 SPORTSMAN RSE 4X4		Type mach.	QUAD
500 RANGER 4X4		Type mach.	QUAD	Année->	2010
Type mach.	QUAD	Année->	2000	->Année	2014
Année->	2000	Oil/Oel :	T 59	Air/Luft :	SA 8995
Oil/Oel :	T 59	Air/Luft :	SA 28995	550 SPORTSMAN EPS TOURING	
Air/Luft :	SA 28995	Air/Luft :	SA 8995	Type mach.	QUAD
Air/Luft :	SA 8995	PREF/VORF		Année->	2010
500 RANGER 6X6		Type mach.	QUAD	->Année	2014
Type mach.	QUAD	Année->	2006	Oil/Oel :	T 59
Année->	2000	->Année	2009	Air/Luft :	SA 8995
Oil/Oel :	T 59	Oil/Oel :	T 59	570 ACE EFI	
Air/Luft :	SA 28995	Air/Luft :	SA 8995	Type mach.	QUAD
Air/Luft :	SA 8995	500 SPORTSMAN X2		Année->	2016
500 RANGER 6X6		Type mach.	QUAD	Oil/Oel :	SO 6943
Type mach.	QUAD	Année->	2008		
Année->	2000	->Année	2009		
Oil/Oel :	T 59	Oil/Oel :	T 59		
Air/Luft :	SA 28995	500 SPORTSMAN X2 EFI			
Air/Luft :	SA 8995	Type mach.	QUAD		
		Année->	2008		
		->Année	2009		
		Oil/Oel :	T 59		

POLARIS		POLARIS		POLARIS	
570 FOREST		600 SPORTSMAN 4X4		800 SPORTSMAN FOREST	
Type mach.	QUAD	Type mach.	QUAD	Type mach.	QUAD
Année->	2014	Année->	2003	Année->	2014
Oil/Oel :	T 59	Oil/Oel :	SO 6943	Oil/Oel :	SO 6943
570 FOREST SPORTSMAN		Air/Luft :	SA 28995	Air/Luft :	SA 8995
Type mach.	QUAD	Air/Luft :	SA 8995	800 SPORTSMAN HO EFI	
Année->	2014	700 RANGER		Type mach.	QUAD
->Année	2016	Type mach.	QUAD	Année->	2008
Oil/Oel :	T 59	Année->	2006	->Année	2009
Air/Luft :	SA 8995	Oil/Oel :	T 8307	Oil/Oel :	SO 6943
570 RANGER RZR		Air/Luft :	SA 7812	Air/Luft :	SA 8995
Type mach.	QUAD	700 SPORTSMAN MV		800 SPORTSMAN TOURING EFI	
Année->	2013	Type mach.	QUAD	Type mach.	QUAD
Air/Luft :	SA 7555	Année->	2005	Année->	2008
570 SPORTSMAN EFI		Oil/Oel :	SO 6943	->Année	2009
Type mach.	QUAD	Air/Luft :	SA 8995	Oil/Oel :	SO 6943
Année->	2014	700 SPORTSMAN TWIN		Air/Luft :	SA 8995
->Année	2016	Type mach.	QUAD	800 SPORTSMAN TWIN F/1	
Oil/Oel :	T 59	Année->	2004	Type mach.	QUAD
570 SPORTSMAN EPS		Oil/Oel :	SO 6943	Année->	2005
Type mach.	QUAD	Air/Luft :	SA 8995	Oil/Oel :	SO 6943
Année->	2014	700 SPORTSMAN TWIN EFI		Air/Luft :	SA 8995
Oil/Oel :	T 59	Type mach.	QUAD	800 SPORTSMAN X2 EFI	
Air/Luft :	SA 8995	Année->	2004	Type mach.	QUAD
570 SPORTSMAN EPS		Oil/Oel :	SO 6943	Année->	2007
Type mach.	QUAD	Air/Luft :	SA 8995	->Année	2009
Année->	2017	700 SPORTSMAN TWIN MOSSY OAK		Oil/Oel :	SO 6943
Oil/Oel :	T 59	Type mach.	QUAD	Air/Luft :	SA 8995
Air/Luft :	SA 8995	Année->	2004	850 SCRAMBLER	
570 SPORTSMAN EPS TOURING		Oil/Oel :	SO 6943	Type mach.	QUAD
Type mach.	QUAD	Air/Luft :	SA 8995	Année->	2017
Année->	2017	700 SPORTSMAN X2		->Année	2019
Oil/Oel :	T 59	Type mach.	QUAD	Oil/Oel :	T 59
Air/Luft :	SA 8995	Année->	2008	Air/Luft :	SA 8995
570 SPORTSMAN SP		Oil/Oel :	SO 6943	850 SCRAMBLER XP HO	
Type mach.	QUAD	Air/Luft :	SA 8995	Type mach.	QUAD
Année->	2015	700 SPORTSMAN 4X4		Année->	2013
->Année	2016	Type mach.	QUAD	->Année	2014
Oil/Oel :	T 59	Année->	2001	Oil/Oel :	T 59
Air/Luft :	SA 8995	Oil/Oel :	SO 6943	Air/Luft :	SA 8995
570 SPORTSMAN XP EFI		Air/Luft :	SA 28995	850 SCRAMBLER XP HO EPS LE	
Type mach.	QUAD	Air/Luft :	SA 8995	Type mach.	QUAD
Année->	2014	800 RANGER		Année->	2013
Oil/Oel :	T 59	Type mach.	QUAD	->Année	2014
570 SPORTSMAN X2 EPS		Année->	2006	Oil/Oel :	T 59
Type mach.	QUAD	Oil/Oel :	SO 6943	Air/Luft :	SA 8995
Année->	2015	Air/Luft :	SA 7812	850 SPORTSMAN HIGH LIFTER	
->Année	2016	800 SPORTSMAN BIG BOSS 6X6		Type mach.	QUAD
Oil/Oel :	T 59	Type mach.	QUAD	Année->	2016
Air/Luft :	SA 8995	Année->	2012	Oil/Oel :	T 59
570 SPORTSMAN 6X6		->Année	2014	Air/Luft :	SA 8995
Type mach.	QUAD	Oil/Oel :	T 59	850 SPORTSMAN SP	
Année->	2019	Air/Luft :	SA 8995	Type mach.	QUAD
Oil/Oel :	T 59	800 SPORTSMAN EFI		Année->	2016
Air/Luft :	SA 8995	Type mach.	QUAD	Oil/Oel :	T 59
600 SPORTSMAN TWIN		Année->	2006	Air/Luft :	SA 8995
Type mach.	QUAD	->Année	2014	850 SPORTSMAN TOURING EPS	
Année->	2004	Oil/Oel :	SO 6943	Type mach.	QUAD
->Année	2006	Air/Luft :	SA 8995	Année->	2012
Air/Luft :	SA 8995			->Année	2015
				Oil/Oel :	T 59
				Air/Luft :	SA 8995

POLARIS

850 SPORTSMAN TOURING EPS

Type mach. QUAD
Année-> 2011
Oil/Oel : T 59
Air/Luft : SA 8995

850 SPORTSMAN TOURING HO EPS

Type mach. QUAD
Année-> 2012
->Année 2014
Air/Luft : SA 8995

850 SPORTSMAN TOURING HO EPS LE

Type mach. QUAD
Année-> 2013
Oil/Oel : T 59
Air/Luft : SA 8995

850 SPORTSMAN WV

Type mach. QUAD
Année-> 2014
Oil/Oel : T 59
Air/Luft : SA 8995

850 SPORTSMAN XP

Type mach. QUAD
Année-> 2009
Oil/Oel : T 59

850 SPORTSMAN XP

Type mach. QUAD
Année-> 2012
->Année 2014
Air/Luft : SA 8995

850 SPORTSMAN X2 LE

Type mach. QUAD
Année-> 2011
Oil/Oel : T 59
Air/Luft : SA 8995

900 ACE EFI EPS

Type mach. QUAD
Année-> 2016
Oil/Oel : SO 6943

900 RANGER 4X4

Type mach. QUAD
Année-> 2011
Air/Luft : SA 8955
Air/Luft : SA 8995

O:140MM OUI/ODER
O:103MM

900 XP RANGER

Type mach. QUAD
Mot.make POLARIS
Oil/Oel : SO 6943
Air/Luft : SA 7555

QUADZILLA

450 R

Type mach. QUAD
Année-> 2009
->Année 2011
Oil/Oel : SO 6994

450 RS

Type mach. QUAD
Année-> 2009
->Année 2011
Oil/Oel : SO 6994

QUADZILLA

450 SPORT

Type mach. QUAD
Année-> 2009
->Année 2011
Oil/Oel : SO 6994

500 CUV E 2X4

Type mach. QUAD
Oil/Oel : T 501

500 CUV E 4X4

Type mach. QUAD
Oil/Oel : T 501

500 ES 4X4

Type mach. QUAD
Oil/Oel : T 501

500 RS 5 2X4

Type mach. QUAD
Oil/Oel : T 501

500 RS 5 4X4

Type mach. QUAD
Oil/Oel : T 501

500 XLC

Type mach. QUAD
Oil/Oel : T 501

600 RS 6 EFI

Type mach. QUAD
Oil/Oel : T 501

SMC QUAD

150

Type mach. QUAD
Année-> 2003

170

Type mach. QUAD
Année-> 2003

200 CRS

Type mach. QUAD
Année-> 2005

250

Type mach. QUAD
Année-> 2003

250 BLAST

Type mach. QUAD
Année-> 2005

320 TRASHER

Type mach. QUAD

330 ARGON

Type mach. QUAD

50 BULLET

Type mach. QUAD

SMC QUAD

50 PROTECTOR

Type mach. QUAD

520 TRASHER

Type mach. QUAD

700 ARGON

Type mach. QUAD

700 URANO DLX

Type mach. QUAD

SPY RACING

350 F1

Type mach. QUAD
Mot.make ZONGSHEN
Oil/Oel : SO 6989

SUMICO

250 G-PART I

Type mach. QUAD
Année-> 2005
Air/Luft : SA 8987

250 HUNTER

Type mach. QUAD
Année-> 2005
Air/Luft : SA 8987

SUZUKI MOTO

125 ALT

Type mach. ATC
Année-> 1983
->Année 1986
Type carr. D/E/F/G
Oil/Oel : SO 6975

125 LT

Type mach. QUAD
Année-> 1983
->Année 1987
Type carr. D/E/F/G/H
Oil/Oel : SO 6975

160 LT QUADRUNNER

Type mach. QUAD
Année-> 2003
->Année 2004
Type carr. K3/K4
Oil/Oel : SO 6988

160 LT-F

Type mach. QUAD
Année-> 1999
->Année 2002
Type carr. X/Y/K1/K2
Oil/Oel : SO 6988

160 LT-F

Type mach. QUAD
Année-> 1991
->Année 1998
Type carr. M/N/P/R/S/T/V/W
Oil/Oel : SO 6988

SUZUKI MOTO

185 ALT
Type mach. ATC
Année-> 1984
->Année 1985
Type carr. E/F
Oil/Oel : SO 6975

185 ALT F 3X6
Type mach. QUAD
Oil/Oel : SO 6988

185 LT
Type mach. QUAD
Année-> 1984
->Année 1987
Type carr. E/F/G/H
Oil/Oel : SO 6975

230 LT
Type mach. QUAD
Année-> 1986
->Année 1993
Type carr. E-H/J/K/L/M/N/P
Oil/Oel : SO 6988

230 LT
Type mach. QUAD
Année-> 1985
->Année 1987
Type carr. GEF/GEG
Oil/Oel : SO 6988

230 LT
Type mach. QUAD
Année-> 1985
->Année 1988
Type carr. SF/SG/SH/SJ
Oil/Oel : SO 6988

230 LT-F
Type mach. QUAD
Année-> 1986
->Année 1987
Type carr. G/H
Oil/Oel : SO 6988

250 LT-E
Type mach. QUAD
Année-> 1985
->Année 1986
Oil/Oel : SO 6988

250 LT-F
Type mach. QUAD
Année-> 1988
->Année 2002
Type carr. J->K2
Oil/Oel : SO 6988
Air/Luft : SA 12268

250 LT-F OZARK
Type mach. QUAD
Année-> 2003
->Année 2007
Type carr. K3->K7
Oil/Oel : SO 6988

250 LT-F OZARK
Type mach. QUAD
Année-> 2009
Type carr. K9

250 LT-F OZARK
Type mach. QUAD
Année-> 2002
->Année 2009
Oil/Oel : SO 6988

SUZUKI MOTO

250 LT-F OZARK
Type mach. QUAD
Année-> 2012
->Année 2014
Oil/Oel : SO 6988

250 LT-Z QUADSPORT
Type mach. QUAD
Année-> 2004
->Année 2007
Type carr. K4->K7
Oil/Oel : SO 6988
Air/Luft : SA 12268

250 LT-Z QUADSPORT
Type mach. QUAD
Année-> 2008
->Année 2009
Type carr. K9
Oil/Oel : SO 6988
Air/Luft : SA 12268

280 KING QUAD
Type mach. QUAD
Année-> 1991
Oil/Oel : SO 6988

280 LTF 4X4 QUADRUNNER
Type mach. QUAD
Année-> 1994
Oil/Oel : SO 6988

300 LT 4-WD
Type mach. QUAD
Année-> 1987
->Année 1999
Oil/Oel : SO 6988

300 LT-E
Type mach. QUAD
Année-> 1987
->Année 1989
Oil/Oel : SO 6988

300 LT-F KING QUAD
Type mach. QUAD
Année-> 2000
->Année 2002
Oil/Oel : SO 6988

300 LTF-FX
Type mach. QUAD
Année-> 1999
Oil/Oel : SO 6988

400 KLT-F FC KING QUAD
Type mach. QUAD
Année-> 2009
Type carr. K9

400 KLT-F FS CAMO
Type mach. QUAD
Année-> 2009
Type carr. K9

400 KLT-F KING QUAD FS
Type mach. QUAD
Année-> 2009
Type carr. K9

SUZUKI MOTO

400 LT-A EIGER 2X4 AUTO
Type mach. QUAD
Année-> 2002
->Année 2004
Type carr. K2/K3/K4
Oil/Oel : SO 6999

400 LT-A F EIGER 4X4 AUTO
Type mach. QUAD
Année-> 2007
Oil/Oel : SO 6999

400 LT-A F EIGER 4X4 AUTO
Type mach. QUAD
Année-> 2002
->Année 2007
Oil/Oel : SO 6999

400 LT-A F KINGQUAD 4X4 AUTO
Type mach. QUAD
Année-> 2008
->Année 2012
Oil/Oel : SO 6999

400 LT-A F KINGQUAD 4X4 AUTO CAMO
Type mach. QUAD
Année-> 2008
->Année 2011
Oil/Oel : SO 6999

400 LT-A F 4X4 AUTO
Type mach. QUAD
Année-> 2002
->Année 2007
Type carr. K2/K3/K4/K5/K6
Oil/Oel : SO 6999

400 LT-F EIGER 2X4
Type mach. QUAD
Année-> 2002
->Année 2004
Type carr. K2/K3/K4
Oil/Oel : SO 6999

400 LT-F F EIGER 4X4
Type mach. QUAD
Année-> 2002
->Année 2004
Type carr. K2/K3/K4
Oil/Oel : SO 6999

400 LT-F FC AUTO 4X4
Type mach. QUAD
Année-> 2004
->Année 2007
Type carr. K4/K5/K6/K7
Oil/Oel : SO 6999

400 LT-R QUADRACER
Type mach. QUAD
Année-> 2008
->Année 2009
Oil/Oel : SO 6999
Air/Luft : SA 7803

400 LT-Z QUADSPORT
Type mach. QUAD
Année-> 2003
->Année 2007
Type carr. K3->K7
Oil/Oel : SO 6979
Air/Luft : SA 12203

400 LT-Z QUADSPORT
Type mach. QUAD
Année-> 2009
Type carr. K9

SUZUKI MOTO

400 LT-Z QUADSPORT Z

Type mach. QUAD
Année-> 2008
->Année 2013
Oil/Oel : SO 6979
Air/Luft : SA 12203

400 LTA F

Type mach. QUAD
Année-> 2000
Oil/Oel : SO 6999
Air/Luft : SA 12203

400 LTA F

Type mach. QUAD
Année-> 2007
Type carr. K7
Oil/Oel : SO 6999
Air/Luft : SA 12203

400 LTF

Type mach. QUAD
Oil/Oel : SO 6999
Air/Luft : SA 12203

400 LTF K7 EIGER 2WD

Type mach. QUAD
Année-> 2007
Oil/Oel : SO 6999

400 Z QUADSPORT

Type mach. QUAD
Année-> 2002
Oil/Oel : SO 6999
Air/Luft : SA 8975

450 LT-A X KING QUAD

Type mach. QUAD
Année-> 2007
Type carr. K7
Oil/Oel : SO 6999

450 LT-A X KING QUAD AXI

Type mach. QUAD
Année-> 2009
Type carr. K9

450 LT-A X KING QUAD AXI

Type mach. QUAD
Année-> 2013
Oil/Oel : SO 6999

450 LT-A XC KING QUAD AXI CAMO

Type mach. QUAD
Année-> 2009
Type carr. K9

450 LT-R QUADRACER

Type mach. QUAD
Année-> 2006
->Année 2007
Type carr. K6->K7
Oil/Oel : SO 6979
Air/Luft : SA 7803

50 LT

Type mach. QUAD

50 LTA

Type mach. QUAD

SUZUKI MOTO

500 LT-A F VINSON

Type mach. QUAD
Année-> 2003
->Année 2007
Type carr. K3/K4/K5/K6/K7
Oil/Oel : SO 6999

500 LT-A FB VINSON 4X4

Type mach. QUAD
Année-> 2004
->Année 2005
Type carr. K4/K5
Oil/Oel : SO 6999

500 LT-A FC VINSON 4X4

Type mach. QUAD
Année-> 2004
->Année 2006
Type carr. K4/K5/K6
Oil/Oel : SO 6999

500 LT-A KINGQUAD AXI

Type mach. QUAD
Année-> 2014
Oil/Oel : SO 6999
Air/Luft : HR 8956

500 LT-A XP KINGQUAD AXI PS/CAMO

Type mach. QUAD
Année-> 2009
->Année 2013
Oil/Oel : SO 6999
Air/Luft : HR 8956

500 LT-F F VINSON 4X4

Type mach. QUAD
Année-> 2002
->Année 2006
Type carr. K2/K3/K4/K5/K6
Oil/Oel : SO 6999
Air/Luft : SA 12337

500 LT-F F VINSON 4X4

Type mach. QUAD
Année-> 2007
Oil/Oel : SO 6999

500 LT-F FC-K5/K6 VINSON 4X4

Type mach. QUAD
Année-> 2005
->Année 2006
Oil/Oel : SO 6999

500 LT-F QUADRUNNER

Type mach. QUAD
Année-> 1998
->Année 2002
Oil/Oel : SO 6999
Air/Luft : SA 12337

500 LTA F QUADRUNNER

Type mach. QUAD
Année-> 1998
->Année 2002
Oil/Oel : SO 6999
Air/Luft : SA 12337

500 LTA XP KINGQUAD AXI PS

Type mach. QUAD
Année-> 2009
->Année 2013
Oil/Oel : SO 6999

SUZUKI MOTO

700 LTA X-K5/K6/K7 KING QUAD

Type mach. QUAD
Année-> 2005
->Année 2007
Oil/Oel : SO 6999

700 LTV TWIN PEAKS

Type mach. QUAD
Année-> 2003
Oil/Oel : SO 6955
Air/Luft : SA 8974

750 LT-A KINGQUAD AXI PS

Type mach. QUAD
Année-> 2014
Oil/Oel : SO 6999
Air/Luft : HR 8956

750 LT-A KINGQUAD AXI 4X4 CAMO

Type mach. QUAD
Année-> 2008
->Année 2013
Oil/Oel : SO 6999
Air/Luft : HR 8956

750 LT-A X KINGQUAD AXI 4X4

Type mach. QUAD
Année-> 2008
->Année 2014
Oil/Oel : SO 6999
Air/Luft : HR 8956

750 LTA X KING QUAD

Type mach. QUAD
Année-> 2008
Type carr. K8
Oil/Oel : SO 6999

750 LTA X KING QUAD AXI

Type mach. QUAD
Année-> 2009
Type carr. K9
Air/Luft : HR 8956

750 LTA XCK KING QUAD AXI CAMO

Type mach. QUAD
Année-> 2009
Type carr. K9
Air/Luft : HR 8956

750 LTA XK KING QUAD AXI CAMO

Type mach. QUAD
Année-> 2009
Type carr. K9
Air/Luft : HR 8956

80 LT

Type mach. QUAD
Air/Luft : SA 12336

90 LT-Z QUADSPORT K7

Type mach. QUAD
Année-> 2007
Oil/Oel : SO 6975

SYM

600 QUAD RAIDER

Type mach. QUAD
Oil/Oel : T 501

TGB	X ROADS	YAMAHA MOTO
1000 BLADE	150	250 YFB
Type mach. QUAD	Type mach. QUAD	Type mach. QUAD
Mot.type V-TWIN	Année-> 2004	Année-> 1994
Oil/Oel : SO 6923		->Année 1999
250 BLADE E/LE 4X2	250 PUMA	Type carr. TIMBERWOLF
Type mach. QUAD	Type mach. QUAD	Oil/Oel : SO 6989
Année-> 2006	Année-> 2004	
325 BLADE 4X2	YAMAHA MOTO	250 YFB
Type mach. QUAD	125 YFA BREEZE	Type mach. QUAD
Année-> 2006	Type mach. QUAD	Année-> 1992
Oil/Oel : T 8307	Année-> 1987	->Année 1995
Air/Luft : SA 7972	->Année 2004	Type carr. D/G
400 AVENGER 4X2	Air/Luft : SA 8969	Oil/Oel : SO 6989
Type mach. QUAD	125 YFM GRIZZLY	250 YFM BEAR TRACKER
Année-> 2006	Type mach. QUAD	Type mach. QUAD
Oil/Oel : T 8307	Année-> 2004	Année-> 1991
Air/Luft : SA 7972	Air/Luft : SA 8969	->Année 2004
425 LE 4X4	125 YFM GRIZZLY	Oil/Oel : SO 6989
Type mach. QUAD	Type mach. QUAD	Air/Luft : SA 8968
Année-> 2006	Année-> 2004	
Oil/Oel : T 8307	Air/Luft : SA 8969	250 YFM BIG BEAR
Air/Luft : SA 7972	125 YFM GRIZZLY	Type mach. QUAD
425 ORANGER 4X4	Type mach. QUAD	Année-> 2007
Type mach. QUAD	Année-> 2007	Oil/Oel : SO 6989
Année-> 2006	->Année 2008	
Oil/Oel : T 8307	Type carr. W->X	250 YFM BRUIN
Air/Luft : SA 7972	125 YFM GRIZZLY HUNTER	Type mach. QUAD
425 OUTBACK	Type mach. QUAD	Année-> 2006
Type mach. QUAD	Année-> 2007	Oil/Oel : SO 6989
Mot.make TGB	->Année 2008	Air/Luft : SA 8968
Oil/Oel : T 8307	Type carr. W->X	250 YFM ERW/ERA/D
Air/Luft : SA 7972	200 YFM DXS/DXW	Type mach. QUAD
425 TARGET	Type mach. QUAD	Année-> 1989
Type mach. QUAD	Année-> 1986	->Année 1993
Mot.make TGB	->Année 1987	Oil/Oel : SO 6989
Oil/Oel : T 8307	Oil/Oel : SO 6989	250 YFM R RAPTORE SE CUSTOM
Air/Luft : SA 7972	200 YFM N	Type mach. QUAD
425 4X4	Type mach. QUAD	Année-> 2008
Type mach. QUAD	Année-> 1985	Oil/Oel : SO 6978
Année-> 2006	->Année 1989	Air/Luft : SA 8969
Oil/Oel : T 8307	Oil/Oel : SO 6989	250 YFM W
Air/Luft : SA 7972	200 YFS BLASTER	Type mach. QUAD
500 BLADE	Type mach. QUAD	Année-> 1989
Type mach. QUAD	Année-> 1987	->Année 1992
Année-> 2010	->Année 2005	Oil/Oel : SO 6989
Mot.make TGB	Air/Luft : SA 8969	250 YFM-R RAPTOR
Oil/Oel : T 8307	200 YTM TRI-MOTO	Type mach. QUAD
Air/Luft : SA 7972	Type mach. QUAD	Année-> 2009
525 TARGET	Année-> 1983	Oil/Oel : SO 6978
Type mach. QUAD	->Année 1985	Air/Luft : SA 8969
Mot.make TGB	Oil/Oel : SO 6989	350 BIG BEAR YFM
Oil/Oel : T 8307	225 YFM S/T/U	Type mach. QUAD
Air/Luft : SA 7972	Type mach. QUAD	Année-> 1996
550 BLADE	Année-> 1986	Oil/Oel : SO 6989
Type mach. QUAD	->Année 1990	350 BIG BEAR YFM 4X4
Mot.make TGB	Oil/Oel : SO 6989	Type mach. QUAD
Oil/Oel : T 8307	225 YTM TRI-MOTO	->Année 1996
Air/Luft : SA 7972	Type mach. QUAD	Oil/Oel : SO 6989
800 BLADE	Année-> 1983	350 BW
Type mach. QUAD	->Année 1986	Type mach. QUAD
Mot.type V-TWIN	Oil/Oel : SO 6989	Oil/Oel : SO 6989
Oil/Oel : SO 6923	230 YFM BEAR TRACKER	
	Type mach. QUAD	
	Année-> 2003	
	->Année 2004	
	Oil/Oel : SO 6989	

YAMAHA MOTO		YAMAHA MOTO		YAMAHA MOTO	
350 FX WOLVERINE 4X4		350 YFM GRIZZLY AUTO 4X4 IRS		350 YFM-R RAPTOR	
Type mach.	QUAD	Type mach.	QUAD	Type mach.	QUAD
Année->	1996	Année->	2007	Année->	2009
->Année	2005	->Année	2012	Oil/Oel :	SO 6989
Oil/Oel :	SO 6989	Oil/Oel :	SO 6955	350 YFP TERRAPRO	
Air/Luft :	SA 2032	Air/Luft :	SA 8966	Type mach.	QUAD
350 YFM		350 YFM R-T/V RAPTOR		Année->	1988
Type mach.	QUAD	Type mach.	QUAD	Oil/Oel :	SO 6989
Année->	1987	Année->	2005	350 YFZ BANSHEE	
->Année	1988	->Année	2006	Type mach.	QUAD
Type carr.	ERT/ERU	Oil/Oel :	SO 6989	Année->	1987
Oil/Oel :	SO 6989	350 YFM R-W RAPTOR		->Année	2006
350 YFM BIGBEAR		Type mach.	QUAD	Air/Luft :	SA 8967
Type mach.	QUAD	Année->	2007	400 KODIAK AUTO 4X4	
Année->	1997	Oil/Oel :	SO 6989	Type mach.	QUAD
->Année	1999	350 YFM RAPTOR		Année->	2000
Type carr.	FWJ/UJ/FWBJ	Type mach.	QUAD	->Année	2003
Oil/Oel :	SO 6989	Année->	2004	Oil/Oel :	T 59
350 YFM BIGBEAR		Oil/Oel :	T 59	Air/Luft :	SA 8987
Type mach.	QUAD	Air/Luft :	SA 8965	400 KODIAK FW	
Année->	1987	350 YFM RSE-W RAPTOR SP.EDIT		Type mach.	QUAD
->Année	1992	Type mach.	QUAD	->Année	1999
Type carr.	FWT/FWU/FWW/FWF	Année->	2007	Oil/Oel :	T 59
Oil/Oel :	SO 6989	Oil/Oel :	SO 6989	Air/Luft :	SA 8987
350 YFM BRUIN		350 YFM RSE2-W RAPTOR SP.EDIT 2		400 YFM BIG BEAR	
Type mach.	QUAD	Type mach.	QUAD	Type mach.	QUAD
Année->	2004	Année->	2007	Année->	1993
Oil/Oel :	T 59	Oil/Oel :	SO 6989	->Année	2002
Air/Luft :	SA 8966	350 YFM UH		Oil/Oel :	SO 6989
350 YFM BRUIN AUTOMATIC 2X4		Type mach.	QUAD	400 YFM BIG BEAR FB IRS	
Type mach.	QUAD	Année->	1996	Type mach.	QUAD
Année->	2004	Oil/Oel :	SO 6989	Année->	2007
->Année	2006	350 YFM WARRIOR X		Oil/Oel :	SO 6989
Oil/Oel :	T 59	Type mach.	QUAD	400 YFM BIG BEAR FW 4X4	
Air/Luft :	SA 8966	Année->	1996	Type mach.	QUAD
350 YFM BRUIN AUTOMATIC 4X4		->Année	2004	Année->	2003
Type mach.	QUAD	Oil/Oel :	SO 6989	->Année	2006
Année->	2004	Air/Luft :	SA 2032	Oil/Oel :	SO 6989
->Année	2006	350 YFM WARRIOR XT/XU		400 YFM BIG BEAR HUNTER IRS FBH	
Oil/Oel :	T 59	Type mach.	QUAD	Type mach.	QUAD
Air/Luft :	SA 8966	Année->	1987	Année->	2007
350 YFM BRUIN AUTOMATIC 4X4 HUNTER		->Année	1988	Oil/Oel :	SO 6989
Type mach.	QUAD	Oil/Oel :	SO 6989	400 YFM BIG BEAR PRO 4X4	
Année->	2005	350 YFM WOLVERINE 2WD		Type mach.	QUAD
->Année	2006	Type mach.	QUAD	Année->	2000
Oil/Oel :	T 59	Année->	2006	->Année	2003
Air/Luft :	SA 8966	->Année	2008	Oil/Oel :	T 59
350 YFM FW-A/B/D/E/F/G		Type carr.	X/V/W/X	Air/Luft :	SA 8968
Type mach.	QUAD	Oil/Oel :	T 59	400 YFM BIG BEAR 2WD N/S	
Année->	1990	Air/Luft :	SA 8966	Type mach.	QUAD
->Année	1995	350 YFM X WARRIOR		Année->	2003
Oil/Oel :	SO 6989	Type mach.	QUAD	->Année	2004
350 YFM GRIZZLY AUTO 2X4		Année->	1989	Oil/Oel :	SO 6989
Type mach.	QUAD	->Année	1995	400 YFM GRIZZLY 4X4	
Année->	2007	Oil/Oel :	SO 6989	Type mach.	QUAD
->Année	2011	Air/Luft :	SA 2032	Année->	2007
Oil/Oel :	SO 6955	350 YFM X-WOLVERINE 2WD		->Année	2008
Air/Luft :	SA 8966	Type mach.	QUAD	Oil/Oel :	SO 6955
350 YFM GRIZZLY AUTO 4X4		Année->	2006		
Type mach.	QUAD	->Année	2009		
Année->	2007	Oil/Oel :	SO 6955		
->Année	2014	Air/Luft :	SA 8966		
Oil/Oel :	SO 6955				
Air/Luft :	SA 8966				



YAMAHA MOTO		YAMAHA MOTO		YAMAHA MOTO	
400 YFM KODIAK		450 YFM KODIAK AUTO 4X4		550 YFM F GRIZZLY FI AUTO 4X4	
Type mach.	QUAD	Type mach.	QUAD	Type mach.	QUAD
Année->	1994	Année->	2003	Année->	2009
->Année	1999			->Année	2014
Type carr.	FWF/FWG/FWH/FWK	Oil/Oel :	T 59	Oil/Oel :	T 59
Oil/Oel :	SO 6989	Air/Luft :	SA 8987		
400 YFM KODIAK AUTO 4X4		450 YFM KODIAK AUTO 4X4		550 YFM F GRIZZLY FI AUTO 4X4 EPS	
Type mach.	QUAD	Type mach.	QUAD	Type mach.	QUAD
Année->	2004	Année->	2004	Année->	2009
->Année	2006	->Année	2006	->Année	2014
Oil/Oel :	T 59	Oil/Oel :	T 59	Oil/Oel :	T 59
450 KODIAK		450 YFM WOLVERINE 4X4 AUTO		550 YFM F GRIZZLY FI AUTO 4X4 EPS SE	
Type mach.	QUAD	Type mach.	QUAD	Type mach.	QUAD
Année->	2001	Année->	2009	Année->	2009
Oil/Oel :	T 59	Air/Luft :	SA 8966	->Année	2014
Air/Luft :	SA 8966	450 YFZ		Oil/Oel :	T 59
450 KODIAK		Type mach.	QUAD	600 YFM GRIZZLY 4X4	
Type mach.	QUAD	Année->	2009	Type mach.	QUAD
Année->	2020	450 YFZ		Année->	1998
Air/Luft :	SA 8966	Type mach.	QUAD	->Année	2001
450 YFM FX WOLVERINE 4X4		Année->	2013	Oil/Oel :	SO 6990
Type mach.	QUAD	Oil/Oel :	SO 6978	Air/Luft :	SA 8966
Année->	2006	450 YFZ BILL BALLANCE EDITION		660 RHINO	
->Année	2008	Type mach.	QUAD	Type mach.	QUAD
Oil/Oel :	SO 6955	Année->	2006	Oil/Oel :	T 59
Air/Luft :	SA 8966	Oil/Oel :	SO 6978	Ess/Be :	RT 2
450 YFM FX WOLVERINE 4X4 AUTO		450 YFZ BILL BALLANCE EDITION		Air/Luft :	SA 7942
Type mach.	QUAD	Type mach.	QUAD	660 YFM F GRIZZLY HUNTER	
Année->	2009	Année->	2007	Type mach.	QUAD
->Année	2011	Oil/Oel :	SO 6978	Année->	2008
Oil/Oel :	SO 6955	450 YFZ R		Type carr.	X8
Air/Luft :	SA 8966	Type mach.	QUAD	Oil/Oel :	T 59
450 YFM GRIZZLY AUTO EPS		Année->	2009	Air/Luft :	SA 8966
Type mach.	QUAD	->Année	2014	660 YFM GRIZZLY	
Année->	2011	Oil/Oel :	SO 6978	Type mach.	QUAD
->Année	2013	450 YFZ RSE SPECIAL EDITION		Année->	2002
Oil/Oel :	SO 6955	Type mach.	QUAD	Oil/Oel :	T 59
Air/Luft :	SA 8966	Année->	2008	Air/Luft :	SA 8965
450 YFM GRIZZLY AUTO 4X4		->Année	2010	660 YFM GRIZZLY AUTO 4X4	
Type mach.	QUAD	Oil/Oel :	SO 6978	Type mach.	QUAD
Année->	2007	450 YFZ SE		Année->	2004
->Année	2011	Type mach.	QUAD	->Année	2008
Oil/Oel :	SO 6955	Année->	2007	Oil/Oel :	SO 6955
Air/Luft :	SA 8966	->Année	2008	Air/Luft :	SA 8966
450 YFM GRIZZLY AUTO 4X4 HUNTER		Oil/Oel :	SO 6978	660 YFM R	
Type mach.	QUAD	450 YFZ X		Type mach.	QUAD
Année->	2009	Type mach.	QUAD	Année->	2003
Oil/Oel :	SO 6955	Année->	2011	->Année	2004
Air/Luft :	SA 8966	Oil/Oel :	SO 6978	Oil/Oel :	SO 6969
450 YFM GRIZZLY EPS		450 YFZ X BILL BALANCE		Air/Luft :	SA 8963
Type mach.	QUAD	Type mach.	QUAD	660 YFM RAPTOR	
Année->	2013	Année->	2010	Type mach.	QUAD
->Année	2014	Oil/Oel :	SO 6978	Année->	2001
Oil/Oel :	SO 6955	450 YZF		->Année	2005
Air/Luft :	SA 8966	Type mach.	QUAD	Oil/Oel :	SO 6969
450 YFM GRIZZLY EPS HUNTER		Année->	2003	Air/Luft :	SA 8963
Type mach.	QUAD	Oil/Oel :	SO 6978	700 RHINO	
Année->	2013	Air/Luft :	SA 8964	Type mach.	QUAD
Oil/Oel :	SO 6955			Année->	2009
Air/Luft :	SA 8966			->Année	2014
				Oil/Oel :	T 59
				Air/Luft :	SA 7814

YAMAHA MOTO

700 YFM F GRIZZLY FI AUTO 4X4

Type mach. QUAD
Année-> 2007
->Année 2014

Oil/Oel : SO 6955

700 YFM F GRIZZLY 4X4 EPS

Type mach. QUAD
Année-> 2007
->Année 2014

Oil/Oel : T 59

700 YFM F GRIZZLY 4X4 EPS SE

Type mach. QUAD
Année-> 2009
->Année 2014

Oil/Oel : T 59

700 YFM FG-GRIZZLY

Type mach. QUAD
Année-> 2009

Oil/Oel : T 59

700 YFM FGPDU GRIZZLY DUE

Type mach. QUAD
Année-> 2009

Oil/Oel : T 59

700 YFM KODIAK 4WD

Type mach. QUAD
Année-> 2016

Oil/Oel : SO 6969

700 YFM R RAPTOR GYTR EDITION

Type mach. QUAD
Année-> 2007

Oil/Oel : SO 6990

Air/Luft : SA 8962

700 YFM R RAPTOR SPE.EDIT

Type mach. QUAD
Année-> 2007

Oil/Oel : SO 6990

700 YFM RAPTOR

Type mach. QUAD
Année-> 2006
->Année 2014

Oil/Oel : T 59

Air/Luft : SA 8962

700 YFM-R RAPTOR

Type mach. QUAD
Année-> 2006
->Année 2014

Oil/Oel : SO 6990

Air/Luft : SA 8962

700 YFM-R RAPTOR SE

Type mach. QUAD
Année-> 2007
->Année 2014

Oil/Oel : SO 6990

Air/Luft : SA 8962

750 GRIZZLI



















Type mach. QUAD
Oil/Oel : T 59

80 BADGER

















Type mach. QUAD



MOTONEIGES - QUADS | SNOWMOBILE - ATV | SCHNEEMOBIL - QUADS

<p>ADLY</p> <p>SA 8989 FILTRE A AIR AIR FILTER LUFTFILTER</p> <p>H : 124 / 106 mm Ø : 89 mm ø : 45 mm</p> 	<p>APRILIA</p> <p>SA 7801 FILTRE A AIR AIR FILTER LUFTFILTER</p> <p>H : 34 mm L : 177 mm l : 91 mm</p> 	<p>APRILIA</p> <p>SO 6961 FILTRE A HUILE OIL FILTER OELFILTER</p> <p>H : 49 / 47 mm Ø : 45 mm ø : 14 mm</p> 
<p>APRILIA</p> <p>SA 12922 FILTRE A AIR AIR FILTER LUFTFILTER</p> <p>H : 27 mm L : 154 mm l : 115 mm</p> 	<p>SA 7956 FILTRE A AIR AIR FILTER LUFTFILTER</p> <p>H : 78 / 73 mm Ø : 108 mm ø : 77.5 / 77.5 mm</p> 	<p>SO 6965 FILTRE A HUILE OIL FILTER OELFILTER</p> <p>H : 99 / 96 mm Ø : 57 mm ø : 25 mm</p> 
<p>SA 5163 FILTRE A AIR AIR FILTER LUFTFILTER</p> <p>H : 54 mm L : 126 mm l : 81 mm</p> 	<p>SA 7975 FILTRE A AIR AIR FILTER LUFTFILTER</p> <p>H : 24 / 15 mm L : 183 mm l : 128 mm</p> 	<p>SO 6982 FILTRE A HUILE OIL FILTER OELFILTER</p> <p>H : 42 / 32 mm Ø : 42 mm ø : 14 / 14 mm</p> 
<p>SA 7062 FILTRE A AIR AIR FILTER LUFTFILTER</p> <p>H : 20 mm L : 224 mm l : 151 mm</p> 	<p>SA 7976 FILTRE A AIR AIR FILTER LUFTFILTER</p> <p>H : 108 mm Ø : 130 mm ø : 98 / 98 mm</p> 	<p>SO 6986 FILTRE A HUILE OIL FILTER OELFILTER</p> <p>H : 74 / 70 mm Ø : 56 mm ø : 25 mm</p> 
<p>SA 7559 FILTRE A AIR AIR FILTER LUFTFILTER</p> <p>H : 31 mm L : 212 mm l : 141 mm</p> 	<p>SA 7982 FILTRE A AIR AIR FILTER LUFTFILTER</p> <p>H : 40 mm L : 152 mm l : 113 mm</p> 	<p>SO 7110 FILTRE A HUILE OIL FILTER OELFILTER</p> <p>H : 51 / 47 mm Ø : 56 mm ø : 25 mm</p> 
<p>SA 7796 FILTRE A AIR AIR FILTER LUFTFILTER</p> <p>H : 55 / 49 mm Ø : 81 mm ø : 51 / 51 mm</p> 	<p>SN 20759 FILTRE A GASOIL FUEL FILTER KRAFTSTOFF-FILTER</p> <p>H : 93 mm Ø : 51 / 50 mm ø : 8 / 8 mm</p> 	<p>ARCTIC CAT</p> <p>BE 215 FILTRE A ESSENCE PETROL FILTER BENZINFILTER</p> <p>H : 90 / 47 mm Ø : 37 / 32 mm ø : 8 / 8 mm</p> 

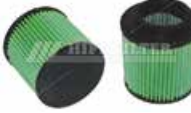
MOTONEIGES - QUADS | SNOWMOBILE - ATV | SCHNEEMOBIL - QUADS





ARCTIC CAT	ARCTIC CAT	ARCTIC CAT
<p>SA 7940 FILTRE A AIR AIR FILTER LUFTFILTER</p>  <p>H : 146 / 0 mm Ø : 86 / 64 mm ø : 60 / 0 mm</p>	<p>SO 6955 FILTRE A HUILE OIL FILTER OELFILTER</p>  <p>H : 66 / 64 mm Ø : 68 / 65 mm ø : M20X1,5</p>	<p>T 1636 FILTRE A HUILE OIL FILTER OELFILTER</p>  <p>H : 73 / 71 mm Ø : 69 / 65 mm ø : 3/4"-16UNF</p>
<p>SA 8138 FILTRE A AIR AIR FILTER LUFTFILTER</p>  <p>H : 52 mm L : 240 mm I : 221 mm</p>	<p>SO 6957 FILTRE A HUILE OIL FILTER OELFILTER</p>  <p>H : 87 / 85 mm Ø : 67,5 / 66 mm ø : M20X1</p>	<p>T 501 FILTRE A HUILE OIL FILTER OELFILTER</p>  <p>H : 68 / 67 mm Ø : 71 / 68 mm ø : 3/4"-16UNF</p>
<p>SA 8953 FILTRE A AIR AIR FILTER LUFTFILTER</p>  <p>H : 15 mm L : 248 mm I : 155 mm</p>	<p>SO 6969 FILTRE A HUILE OIL FILTER OELFILTER</p>  <p>H : 52 / 50 mm Ø : 72 / 68 mm ø : M20X1,5</p>	<p>AXR</p> <p>SA 8987 FILTRE A AIR AIR FILTER LUFTFILTER</p>  <p>H : 155 / 150 mm Ø : 89 mm ø : 58 mm</p>
<p>SA 8988 FILTRE A AIR AIR FILTER LUFTFILTER</p>  <p>H : 19 mm L : 327 mm I : 193 mm</p>	<p>SO 6979 FILTRE A HUILE OIL FILTER OELFILTER</p>  <p>H : 44 mm Ø : 44 mm ø : 13,5 mm</p>	<p>SA 8989 FILTRE A AIR AIR FILTER LUFTFILTER</p>  <p>H : 124 / 106 mm Ø : 89 mm ø : 45 mm</p>
<p>SA 8990 FILTRE A AIR AIR FILTER LUFTFILTER</p>  <p>H : 103 / 93 mm Ø : 93 / 83 mm ø : 49 mm</p>	<p>SO 6988 FILTRE A HUILE OIL FILTER OELFILTER</p>  <p>H : 55 mm Ø : 44 mm ø : 13,5 mm</p>	<p>BENELLI</p> <p>SA 10331 FILTRE A AIR AIR FILTER LUFTFILTER</p>  <p>H : 83 mm Ø : 110 mm ø : 76 / 76 mm</p>
<p>SA 8991 FILTRE A AIR AIR FILTER LUFTFILTER</p>  <p>H : 134 / 117 mm Ø : 120 mm ø : 73 mm</p>	<p>SO 6999 FILTRE A HUILE OIL FILTER OELFILTER</p>  <p>H : 66 / 65 mm Ø : 71 / 68 mm ø : M20X1</p>	<p>SA 12832 FILTRE A AIR AIR FILTER LUFTFILTER</p>  <p>H : 30 mm L : 190 mm I : 80 mm</p>



MOTONEIGES - QUADS | SNOWMOBILE - ATV | SCHNEEMOBIL - QUADS



















<p>BENELLI</p> <p>SA 218 FILTRE A AIR AIR FILTER LUFTFILTER</p> <p>H : 57 / 51 mm Ø : 173 mm ø : 128 / 128 mm</p> 	<p>BENELLI</p> <p>T 59 FILTRE A HUILE OIL FILTER OELFILTER</p> <p>H : 73 / 72 mm Ø : 68 / 65 mm ø : M20X1,5</p> 	<p>BIMOTA</p> <p>SO 7110 FILTRE A HUILE OIL FILTER OELFILTER</p> <p>H : 51 / 47 mm Ø : 56 mm ø : 25 mm</p> 	
<p>SO 4126 FILTRE A HUILE OIL FILTER OELFILTER</p> <p>H : 81 / 79 mm Ø : 71 mm ø : 21 / 21 mm</p> 	<p>BETAMOTOR</p> <p>SO 6985 FILTRE A HUILE OIL FILTER OELFILTER</p> <p>H : 52 / 49 mm Ø : 42 mm ø : 11.5 mm</p> 		<p>T 59 FILTRE A HUILE OIL FILTER OELFILTER</p> <p>H : 73 / 72 mm Ø : 68 / 65 mm ø : M20X1,5</p> 
<p>SO 6076 FILTRE A HUILE OIL FILTER OELFILTER</p> <p>H : 57 mm Ø : 76 mm ø : 20 / 20 mm</p> 	<p>SO 6998 FILTRE A HUILE OIL FILTER OELFILTER</p> <p>H : 34 mm Ø : 60 mm ø : 17 mm</p> 	<p>BMW</p> <p>SO 7053 FILTRE A HUILE OIL FILTER OELFILTER</p> <p>H : 128 / 119 mm Ø : 42 mm ø : 13.5 / 13.5 mm</p> 	
<p>SO 6963 FILTRE A HUILE OIL FILTER OELFILTER</p> <p>H : 67 / 65 mm Ø : 66 / 65 mm ø : M20X1,5</p> 	<p>SO 7095 FILTRE A HUILE OIL FILTER OELFILTER</p> <p>H : 70 / 68 mm Ø : 42 mm ø : 11.5 mm</p> 	<p>BMW MOTO</p> <p>SA 10175 FILTRE A AIR AIR FILTER LUFTFILTER</p> <p>H : 26 mm L : 219 mm I : 193 mm</p> 	
<p>SO 6967 FILTRE A HUILE OIL FILTER OELFILTER</p> <p>H : 67 / 65 mm Ø : 55 / 52 mm ø : M14X1,5</p> 	<p>BIMOTA</p> <p>SO 129 FILTRE A HUILE OIL FILTER OELFILTER</p> <p>H : 74 / 72 mm Ø : 79 / 76 mm ø : M16X1,5</p> 	<p>SA 11112 FILTRE A AIR AIR FILTER LUFTFILTER</p> <p>H : 70 mm Ø : 97.5 mm ø : 60 / 60 mm</p> 	
<p>SO 8003 FILTRE A HUILE OIL FILTER OELFILTER</p> <p>H : 61 / 59 mm Ø : 78 / 76 mm ø : M16X1,5</p> 	<p>SO 6999 FILTRE A HUILE OIL FILTER OELFILTER</p> <p>H : 66 / 65 mm Ø : 71 / 68 mm ø : M20X1</p> 	<p>SA 12035 FILTRE A AIR AIR FILTER LUFTFILTER</p> <p>H : 81 / 74 mm Ø : 106 mm ø : 60 / 60 mm</p> 	

MOTONEIGES - QUADS | SNOWMOBILE - ATV | SCHNEEMOBIL - QUADS

















BMW MOTO	BMW MOTO	BMW MOTO
<p>SA 5048 FILTRE A AIR AIR FILTER LUFTFILTER</p>  <p>H : 42.5 mm L : 211 mm I : 167 mm</p>	<p>SA 5163 FILTRE A AIR AIR FILTER LUFTFILTER</p>  <p>H : 54 mm L : 126 mm I : 81 mm</p>	<p>SO 6947 FILTRE A HUILE OIL FILTER OELFILTER</p>  <p>H : 63 / 61 mm Ø : 78 / 76 mm ø : 3/4"-16UNF</p>
<p>SA 5134 FILTRE A AIR AIR FILTER LUFTFILTER</p>  <p>H : 89 / 78 mm Ø : 150 mm ø : 75 / 75 mm</p>	<p>SA 5183 FILTRE A AIR AIR FILTER LUFTFILTER</p>  <p>H : 45 mm L : 122 mm I : 115 mm</p>	<p>SO 6962 FILTRE A HUILE OIL FILTER OELFILTER</p>  <p>H : 87 / 85 mm Ø : 42 mm ø : 12 mm</p>
<p>SA 5144 FILTRE A AIR AIR FILTER LUFTFILTER</p>  <p>H : 89 mm Ø : 128 mm ø : 84 / 84 mm</p>	<p>SA 5184 FILTRE A AIR AIR FILTER LUFTFILTER</p>  <p>H : 68 mm L : 153 mm I : 93 mm</p>	<p>SO 6973 FILTRE A HUILE OIL FILTER OELFILTER</p>  <p>H : 55 / 53 mm Ø : 78 / 76 mm ø : 3/4"-16UNF</p>
<p>SA 5159 FILTRE A AIR AIR FILTER LUFTFILTER</p>  <p>H : 57 mm L : 108 mm I : 72 mm</p>	<p>SA 6021 FILTRE A AIR AIR FILTER LUFTFILTER</p>  <p>H : 112 / 107 mm Ø : 127 mm ø : 77 / 77 mm</p>	<p>SO 6982 FILTRE A HUILE OIL FILTER OELFILTER</p>  <p>H : 42 / 32 mm Ø : 42 mm ø : 14 / 14 mm</p>
<p>SA 5161 FILTRE A AIR AIR FILTER LUFTFILTER</p>  <p>H : 48 / 43 mm L : 225 / 217 mm I : 103 / 97 mm</p>	<p>SA 7796 FILTRE A AIR AIR FILTER LUFTFILTER</p>  <p>H : 55 / 49 mm Ø : 81 mm ø : 51 / 51 mm</p>	<p>SO 7040 FILTRE A HUILE OIL FILTER OELFILTER</p>  <p>H : 129 / 119 mm Ø : 42 mm ø : 13.5 / 13.5 mm</p>
<p>SA 5162 FILTRE A AIR AIR FILTER LUFTFILTER</p>  <p>H : 80 / 70 mm Ø : 118 mm ø : 75 / 75 mm</p>	<p>SA 7930 FILTRE A AIR AIR FILTER LUFTFILTER</p>  <p>H : 64 mm L : 143 mm I : 112 mm</p>	<p>SO 7050 FILTRE A HUILE OIL FILTER OELFILTER</p>  <p>H : 139 / 134 mm Ø : 42 mm ø : 15 / 13 mm</p>



MOTONEIGES - QUADS | SNOWMOBILE - ATV | SCHNEEMOBIL - QUADS



















BMW MOTO	BOMBARDIER	BOMBARDIER
<p>SO 7053 FILTRE A HUILE OIL FILTER OELFILTER</p>  <p>H : 128 / 119 mm Ø : 42 mm ø : 13.5 / 13.5 mm</p>	<p>SA 7979 FILTRE AAIR AIR FILTER LUFTFILTER</p>  <p>H : 32 mm L : 275 mm l : 110 mm</p>	<p>SO 6965 FILTRE A HUILE OIL FILTER OELFILTER</p>  <p>H : 99 / 96 mm Ø : 57 mm ø : 25 mm</p>
<p>SO 7110 FILTRE A HUILE OIL FILTER OELFILTER</p>  <p>H : 51 / 47 mm Ø : 56 mm ø : 25 mm</p>	<p>SA 8984 FILTRE AAIR AIR FILTER LUFTFILTER</p>  <p>H : 131 / 115 mm Ø : 110 mm ø : 72 mm</p>	<p>SO 6977 FILTRE A HUILE OIL FILTER OELFILTER</p>  <p>H : 106 / 99 mm Ø : 56 mm ø : 25 / 25 mm</p>
<p>SO 9001 FILTRE A HUILE OIL FILTER OELFILTER</p>  <p>H : 78 / 77 mm Ø : 79 / 77 mm ø : 3/4"-16UNF</p>	<p>SA 8985 FILTRE AAIR AIR FILTER LUFTFILTER</p>  <p>H : 144 / 130 mm Ø : 101 / 75 mm ø : 50 mm</p>	<p>SO 6981 FILTRE A HUILE OIL FILTER OELFILTER</p>  <p>H : 37 / 32 mm Ø : 42 mm ø : 19 / 14 mm</p>
<p>T 1636 FILTRE A HUILE OIL FILTER OELFILTER</p>  <p>H : 73 / 71 mm Ø : 69 / 65 mm ø : 3/4"-16UNF</p>	<p>SA 8993 FILTRE AAIR AIR FILTER LUFTFILTER</p>  <p>H : 174 / 150 mm Ø : 126 / 98 mm ø : 96 mm</p>	<p>SO 6983 FILTRE A HUILE OIL FILTER OELFILTER</p>  <p>H : 74 / 73 mm Ø : 88 / 87 mm ø : 3/4"-16UNF</p>
BOMBARDIER		
<p>BE 215 FILTRE A ESSENCE PETROL FILTER BENZINFILTER</p>  <p>H : 90 / 47 mm Ø : 37 / 32 mm ø : 8 / 8 mm</p>	<p>SO 6935 FILTRE A HUILE OIL FILTER OELFILTER</p>  <p>H : 100 / 97 mm Ø : 57 mm ø : 25 mm</p>	<p>SO 6986 FILTRE A HUILE OIL FILTER OELFILTER</p>  <p>H : 74 / 70 mm Ø : 56 mm ø : 25 mm</p>
<p>SA 11723 FILTRE AAIR AIR FILTER LUFTFILTER</p>  <p>H : 40 mm L : 204 mm l : 133 mm</p>	<p>SO 6951 FILTRE A HUILE OIL FILTER OELFILTER</p>  <p>H : 49 / 44 mm Ø : 41 mm ø : 14 mm</p>	<p>SO 7110 FILTRE A HUILE OIL FILTER OELFILTER</p>  <p>H : 51 / 47 mm Ø : 56 mm ø : 25 mm</p>

MOTONEIGES - QUADS | SNOWMOBILE - ATV | SCHNEEMOBIL - QUADS









<p>BUELL</p> <p>SO 6964 FILTRE A HUILE OIL FILTER OELFILTER</p> <p>H : 87 / 85.5 mm Ø : 75 / 74 mm ø : 3/4"-16UNF</p> 	<p>CAGIVA MOTO</p> <p>SA 7063 FILTRE A AIR AIR FILTER LUFTFILTER</p> <p>H : 8 mm Ø : 110 mm</p> 	<p>CAGIVA MOTO</p> <p>SO 131 FILTRE A HUILE OIL FILTER OELFILTER</p> <p>H : 60 / 58 mm Ø : 78 / 75.5 mm ø : 3/4"-16UNF</p> 	
<p>SO 6965 FILTRE A HUILE OIL FILTER OELFILTER</p> <p>H : 99 / 96 mm Ø : 57 mm ø : 25 mm</p> 	<p>SA 7784 FILTRE A AIR AIR FILTER LUFTFILTER</p> <p>H : 87 / 84 mm Ø : 143 / 67 mm ø : 115 / 37 mm</p> 	<p>SO 25529 FILTRE A HUILE OIL FILTER OELFILTER</p> <p>H : 53 / 51 mm Ø : 55 mm ø : 18 mm</p> 	
<p>T 1636 FILTRE A HUILE OIL FILTER OELFILTER</p> <p>H : 73 / 71 mm Ø : 69 / 65 mm ø : 3/4"-16UNF</p> 	<p>SA 7989 FILTRE A AIR AIR FILTER LUFTFILTER</p> <p>H : 118 / 107 mm Ø : 90 mm ø : 64 / 64 mm</p> 	<p>SO 6961 FILTRE A HUILE OIL FILTER OELFILTER</p> <p>H : 49 / 47 mm Ø : 45 mm ø : 14 mm</p> 	
CAGIVA MOTO			
<p>SA 1452 FILTRE A AIR AIR FILTER LUFTFILTER</p> <p>H : 49 mm L : 222 mm I : 135 mm</p> 	<p>SN 20759 FILTRE A GASOIL FUEL FILTER KRAFTSTOFF-FILTER</p> <p>H : 93 mm Ø : 51 / 50 mm ø : 8 / 8 mm</p> 	<p>SO 6999 FILTRE A HUILE OIL FILTER OELFILTER</p> <p>H : 66 / 65 mm Ø : 71 / 68 mm ø : M20X1</p> 	
<p>SA 7057 FILTRE A AIR AIR FILTER LUFTFILTER</p> <p>H : 130 mm Ø : 130 / 118 / 80 mm ø : 68 mm</p> 	<p>SO 128 FILTRE A HUILE OIL FILTER OELFILTER</p> <p>H : 91 / 88.5 mm Ø : 79 / 76 mm ø : 3/4"-16UNF</p> 	CANNONDALE	
<p>SA 7060 FILTRE A AIR AIR FILTER LUFTFILTER</p> <p>H : 198 mm Ø : 76 mm ø : 56 / 56 mm</p> 	<p>SO 129 FILTRE A HUILE OIL FILTER OELFILTER</p> <p>H : 74 / 72 mm Ø : 79 / 76 mm ø : M16X1,5</p> 	CF MOTO	
		<p>SO 6986 FILTRE A HUILE OIL FILTER OELFILTER</p> <p>H : 74 / 70 mm Ø : 56 mm ø : 25 mm</p> 	



MOTONEIGES - QUADS | SNOWMOBILE - ATV | SCHNEEMOBIL - QUADS



















DAELIM	DINLI	DUCATI
<p>SA 7813 FILTRE A AIR AIR FILTER LUFTFILTER</p> <p>H : 132 mm Ø : 95 mm ø : 54 mm</p> 	<p>SA 8989 FILTRE A AIR AIR FILTER LUFTFILTER</p> <p>H : 124 / 106 mm Ø : 89 mm ø : 45 mm</p> 	<p>SA 7063 FILTRE A AIR AIR FILTER LUFTFILTER</p> <p>H : 8 mm Ø : 110 mm</p> 
<p>SO 6966 FILTRE A HUILE OIL FILTER OELFILTER</p> <p>H : 48 / 46 mm Ø : 47 / 41 mm ø : 10 mm</p> 	<p>T 501 FILTRE A HUILE OIL FILTER OELFILTER</p> <p>H : 68 / 67 mm Ø : 71 / 68 mm ø : 3/4"-16UNF</p> 	<p>SA 7828 FILTRE A AIR AIR FILTER LUFTFILTER</p> <p>H : 141 / 129 mm Ø : 92 mm ø : 56 / 56 mm</p> 
DELTA ALLIS		
<p>SO 6988 FILTRE A HUILE OIL FILTER OELFILTER</p> <p>H : 55 mm Ø : 44 mm ø : 13.5 mm</p> 	<p>T 59 FILTRE A HUILE OIL FILTER OELFILTER</p> <p>H : 73 / 72 mm Ø : 68 / 65 mm ø : M20X1,5</p> 	<p>SA 7974 FILTRE A AIR AIR FILTER LUFTFILTER</p> <p>H : 26 / 16 mm L : 285 mm l : 216 mm</p> 
<p>SO 6999 FILTRE A HUILE OIL FILTER OELFILTER</p> <p>H : 66 / 65 mm Ø : 71 / 68 mm ø : M20X1</p> 	DUCATI	
<p>SO 6999 FILTRE A HUILE OIL FILTER OELFILTER</p> <p>H : 66 / 65 mm Ø : 71 / 68 mm ø : M20X1</p> 	<p>RT 1 FILTRE A CARBURANT FUEL FILTER TREIBSTOFF-FILTER</p> <p>H : 121 / 60 mm Ø : 50 / 44 mm ø : 8 / 6 mm</p> 	<p>SA 7986 FILTRE A AIR AIR FILTER LUFTFILTER</p> <p>H : 62.5 / 61 mm Ø : 113 mm ø : 71 / 71 mm</p> 
DERBI		
<p>SO 6967 FILTRE A HUILE OIL FILTER OELFILTER</p> <p>H : 67 / 65 mm Ø : 55 / 52 mm ø : M14X1,5</p> 	<p>SA 1481 FILTRE A AIR AIR FILTER LUFTFILTER</p> <p>H : 32 mm L : 212 mm l : 212 mm</p> 	<p>SA 7989 FILTRE A AIR AIR FILTER LUFTFILTER</p> <p>H : 118 / 107 mm Ø : 90 mm ø : 64 / 64 mm</p> 
<p>SO 6990 FILTRE A HUILE OIL FILTER OELFILTER</p> <p>H : 61 / 51 mm Ø : 55 mm ø : 18 mm</p> 	<p>SA 7060 FILTRE A AIR AIR FILTER LUFTFILTER</p> <p>H : 198 mm Ø : 76 mm ø : 56 / 56 mm</p> 	<p>SN 20759 FILTRE A GASOIL FUEL FILTER KRAFTSTOFF-FILTER</p> <p>H : 93 mm Ø : 51 / 50 mm ø : 8 / 8 mm</p> 

MOTONEIGES - QUADS | SNOWMOBILE - ATV | SCHNEEMOBIL - QUADS

<p>DUCATI</p> <p>SO 129 FILTRE A HUILE OIL FILTER OELFILTER</p>  <p>H : 74 / 72 mm Ø : 79 / 76 mm ø : M16X1,5</p>	<p>FANTIC</p> <p>SA 4064 FILTRE A AIR AIR FILTER LUFTFILTER</p>  <p>H : 78 mm L : 240 mm l : 169 mm</p>	<p>GILERA</p> <p>SO 6967 FILTRE A HUILE OIL FILTER OELFILTER</p>  <p>H : 67 / 65 mm Ø : 55 / 52 mm ø : M14X1,5</p>
<p>SO 131 FILTRE A HUILE OIL FILTER OELFILTER</p>  <p>H : 60 / 58 mm Ø : 78 / 75.5 mm ø : 3/4"-16UNF</p>	<p>GAS GAS</p> <p>SO 6994 FILTRE A HUILE OIL FILTER OELFILTER</p>  <p>H : 38 / 36 mm Ø : 50 mm ø : 12.5 mm</p>	<p>GOES</p> <p>SA 8989 FILTRE A AIR AIR FILTER LUFTFILTER</p>  <p>H : 124 / 106 mm Ø : 89 mm ø : 45 mm</p>
<p>SO 6930 FILTRE A HUILE OIL FILTER OELFILTER</p>  <p>H : 130 / 128 mm Ø : 43 mm ø : 16 mm</p>	<p>GILERA</p> <p>SA 312 FILTRE A AIR AIR FILTER LUFTFILTER</p>  <p>H : 48 mm L : 199 mm l : 93 mm</p>	<p>HARLEY DAVIDSON</p> <p>SA 10793 FILTRE A AIR AIR FILTER LUFTFILTER</p>  <p>H : 50 / 50 mm Ø : 152 mm ø : 118 / 118 mm</p> <p>PREFILTER/VORFILTER: SA 20793</p>
<p>SO 8996 FILTRE A HUILE OIL FILTER OELFILTER</p>  <p>H : 58 / 51 mm Ø : 50 mm ø : 14 / 14 mm</p>	<p>SA 521 FILTRE A AIR AIR FILTER LUFTFILTER</p>  <p>H : 50 mm L : 176 mm l : 90 mm</p>	<p>SA 16165 FILTRE A AIR AIR FILTER LUFTFILTER</p>  <p>H : 93 / 83 mm Ø : 86 mm ø : 42 mm</p>
<p>FANTIC</p> <p>SA 10331 FILTRE A AIR AIR FILTER LUFTFILTER</p>  <p>H : 83 mm Ø : 110 mm ø : 76 / 76 mm</p>	<p>SO 129 FILTRE A HUILE OIL FILTER OELFILTER</p>  <p>H : 74 / 72 mm Ø : 79 / 76 mm ø : M16X1,5</p>	<p>SO 059 FILTRE A HUILE OIL FILTER OELFILTER</p>  <p>H : 80 / 77 mm Ø : 78 / 77 mm ø : 3/4"-16UNF</p>
<p>SA 12921 FILTRE A AIR AIR FILTER LUFTFILTER</p>  <p>H : 41 mm L : 142 mm l : 65 mm</p>	<p>SO 131 FILTRE A HUILE OIL FILTER OELFILTER</p>  <p>H : 60 / 58 mm Ø : 78 / 75.5 mm ø : 3/4"-16UNF</p>	<p>SO 11044 FILTRE A HUILE OIL FILTER OELFILTER</p>  <p>H : 123 / 121 mm Ø : 74 / 74 mm ø : 3/4"-16UNF</p>



MOTONEIGES - QUADS | SNOWMOBILE - ATV | SCHNEEMOBIL - QUADS















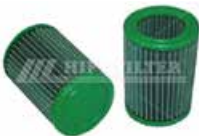

HARLEY DAVIDSON	HONDA MOTO	HONDA MOTO
<p>SO 3335 FILTRE A HUILE OIL FILTER OELFILTER</p> <p>H : 88 / 86 mm Ø : 78 / 76 mm ø : 3/4"-16UNF</p> 	<p>SA 7785 FILTRE A AIR AIR FILTER LUFTFILTER</p> <p>H : 120 mm Ø : 200 / 180 mm</p> 	<p>SA 7817 FILTRE A AIR AIR FILTER LUFTFILTER</p> <p>H : 73 / 57 mm Ø : 171 mm ø : 163 mm</p> 
<p>SO 6937 FILTRE A HUILE OIL FILTER OELFILTER</p> <p>H : 94 / 92 mm Ø : 76 / 76 mm ø : 3/4"-16UNF</p> 	<p>SA 7788 FILTRE A AIR AIR FILTER LUFTFILTER</p> <p>H : 57 / 25 mm L : 294 mm I : 150 mm</p> 	<p>SA 7819 FILTRE A AIR AIR FILTER LUFTFILTER</p> <p>H : 100 / 96 mm Ø : 130 mm ø : 90 mm</p> 
<p>SO 6949 FILTRE A HUILE OIL FILTER OELFILTER</p> <p>H : 87 / 85 mm Ø : 75 / 74 mm ø : 13/16"-16UN</p> 	<p>SA 7790 FILTRE A AIR AIR FILTER LUFTFILTER</p> <p>H : 142 / 132 mm Ø : 103 / 95 mm ø : 62 mm</p> 	<p>SA 7823 FILTRE A AIR AIR FILTER LUFTFILTER</p> <p>H : 154 / 131 mm Ø : 95 mm ø : 62 mm</p> 
<p>SO 6964 FILTRE A HUILE OIL FILTER OELFILTER</p> <p>H : 87 / 85.5 mm Ø : 75 / 74 mm ø : 3/4"-16UNF</p> 	<p>SA 7797 FILTRE A AIR AIR FILTER LUFTFILTER</p> <p>H : 90 mm Ø : 201 / 180 mm</p> 	<p>SA 7827 FILTRE A AIR AIR FILTER LUFTFILTER</p> <p>H : 98 / 95 mm Ø : 144 / 120 mm ø : 99 / 90 mm</p> 
<p>T 1636 FILTRE A HUILE OIL FILTER OELFILTER</p> <p>H : 73 / 71 mm Ø : 69 / 65 mm ø : 3/4"-16UNF</p> 	<p>SA 7800 FILTRE A AIR AIR FILTER LUFTFILTER</p> <p>H : 206 / 201 mm Ø : 128 / 68 mm ø : 43 / 34 mm</p> 	<p>SA 7829 FILTRE A AIR AIR FILTER LUFTFILTER</p> <p>H : 89 / 87 mm Ø : 92 / 61 mm ø : 51 / 25 mm</p> 
HONDA MOTO		
<p>BE 4051 FILTRE A CARBURANT FUEL FILTER TREIBSTOFF-FILTER</p> <p>H : 101 / 60 mm Ø : 34 / 28 mm ø : 10 / 10 mm</p> 	<p>SA 7806 FILTRE A AIR AIR FILTER LUFTFILTER</p> <p>H : 130 / 123 mm Ø : 102 mm ø : 68 mm</p> 	<p>SA 7889 FILTRE A AIR AIR FILTER LUFTFILTER</p> <p>H : 124 / 113 mm Ø : 173 / 121 mm ø : 126 / 74 mm</p> 

MOTONEIGES - QUADS | SNOWMOBILE - ATV | SCHNEEMOBIL - QUADS



















HONDA MOTO	HONDA MOTO	HONDA MOTO
<p>SA 7896 FILTRE A AIR AIR FILTER LUFTFILTER</p>  <p>H : 137 / 133 mm Ø : 102 mm ø : 68 mm</p>	<p>SA 7908 FILTRE A AIR AIR FILTER LUFTFILTER</p>  <p>H : 25 mm L : 281 / 254 mm l : 176 / 149 mm</p>	<p>SA 7918 FILTRE A AIR AIR FILTER LUFTFILTER</p>  <p>H : 115 mm Ø : 178 / 173 mm ø : 110 / 6 mm</p>
<p>SA 7903 FILTRE A AIR AIR FILTER LUFTFILTER</p>  <p>H : 85 / 78 mm Ø : 143 / 78 mm ø : 105 / 40 mm</p>	<p>SA 7909 FILTRE A AIR AIR FILTER LUFTFILTER</p>  <p>H : 33 / 26 mm L : 309 mm l : 218 mm</p>	<p>SA 7919 FILTRE A AIR AIR FILTER LUFTFILTER</p>  <p>H : 37 / 31 mm L : 343 mm l : 153 mm</p>
<p>SA 7904 FILTRE A AIR AIR FILTER LUFTFILTER</p>  <p>H : 32 mm L : 303 mm l : 208 mm</p>	<p>SA 7910 FILTRE A AIR AIR FILTER LUFTFILTER</p>  <p>H : 24 mm L : 308 mm l : 230 mm</p>	<p>SA 7920 FILTRE A AIR AIR FILTER LUFTFILTER</p>  <p>H : 101 / 99 mm Ø : 165 / 120 mm ø : 125 / 80 mm</p>
<p>SA 7905 FILTRE A AIR AIR FILTER LUFTFILTER</p>  <p>H : 132 / 121 mm Ø : 151 / 107 mm ø : 78 mm</p>	<p>SA 7912 FILTRE A AIR AIR FILTER LUFTFILTER</p>  <p>H : 33 mm L : 244 mm l : 228 mm</p>	<p>SA 7923 FILTRE A AIR AIR FILTER LUFTFILTER</p>  <p>H : 56 mm L : 328 mm l : 194 mm</p>
<p>SA 7906 FILTRE A AIR AIR FILTER LUFTFILTER</p>  <p>H : 71 / 65 mm Ø : 268 / 97 mm ø : 218 / 47 mm</p>	<p>SA 7915 FILTRE A AIR AIR FILTER LUFTFILTER</p>  <p>H : 120 / 114 mm Ø : 206 / 94 mm ø : 166 / 54 mm</p>	<p>SA 7924 FILTRE A AIR AIR FILTER LUFTFILTER</p>  <p>H : 71 mm Ø : 231 / 95 mm</p>
<p>SA 7907 FILTRE A AIR AIR FILTER LUFTFILTER</p>  <p>H : 24 mm L : 402 mm l : 212 mm</p>	<p>SA 7917 FILTRE A AIR AIR FILTER LUFTFILTER</p>  <p>H : 117 / 106 mm Ø : 113 mm ø : 98 mm</p>	<p>SA 7925 FILTRE A AIR AIR FILTER LUFTFILTER</p>  <p>H : 146 mm Ø : 98 mm ø : 66 mm</p>



MOTONEIGES - QUADS | SNOWMOBILE - ATV | SCHNEEMOBIL - QUADS













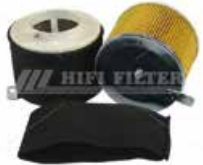





HONDA MOTO	HONDA MOTO	HONDA MOTO
<p>SA 7926</p> <p>FILTRE A AIR AIR FILTER LUFTFILTER</p> <p>H : 45 / 22 mm L : 214 / 190 mm I : 184 mm</p> 	<p>SA 7955</p> <p>FILTRE A AIR AIR FILTER LUFTFILTER</p> <p>H : 71 mm Ø : 268 mm ø : 225 / 225 mm</p> 	<p>SA 8978</p> <p>FILTRE A AIR AIR FILTER LUFTFILTER</p> <p>H : 157 / 142 mm Ø : 120 mm ø : 72 mm</p> 
<p>SA 7931</p> <p>FILTRE A AIR AIR FILTER LUFTFILTER</p> <p>H : 21 mm L : 330 mm I : 270 mm</p> 	<p>SA 7966</p> <p>FILTRE A AIR AIR FILTER LUFTFILTER</p> <p>H : 104 / 100 mm Ø : 133 / 71 mm ø : 7 mm</p> 	<p>SA 8979</p> <p>FILTRE A AIR AIR FILTER LUFTFILTER</p> <p>H : 175 / 160 mm Ø : 120 / 100 mm ø : 70 mm</p> 
<p>SA 7932</p> <p>FILTRE A AIR AIR FILTER LUFTFILTER</p> <p>H : 75 / 58 mm L : 277 mm I : 277 mm</p> 	<p>SA 7967</p> <p>FILTRE A AIR AIR FILTER LUFTFILTER</p> <p>H : 59 mm Ø : 161.5 / 111 mm ø : 121 / 70 mm</p> 	<p>SA 8981</p> <p>FILTRE A AIR AIR FILTER LUFTFILTER</p> <p>H : 164 / 148 mm Ø : 122 / 75 mm ø : 104 mm</p> 
<p>SA 7937</p> <p>FILTRE A AIR AIR FILTER LUFTFILTER</p> <p>H : 137 / 136 mm Ø : 98 / 95 mm ø : 63 mm</p> 	<p>SA 7968</p> <p>FILTRE A AIR AIR FILTER LUFTFILTER</p> <p>H : 79 mm Ø : 162 / 159 mm</p> 	<p>SA 8984</p> <p>FILTRE A AIR AIR FILTER LUFTFILTER</p> <p>H : 131 / 115 mm Ø : 110 mm ø : 72 mm</p> 
<p>SA 7953</p> <p>FILTRE A AIR AIR FILTER LUFTFILTER</p> <p>H : 57 / 25 mm L : 363 mm I : 240 mm</p> 	<p>SA 7969</p> <p>FILTRE A AIR AIR FILTER LUFTFILTER</p> <p>H : 88.5 / 85 mm Ø : 92 mm ø : 48 mm</p> 	<p>SA 8996</p> <p>FILTRE A AIR AIR FILTER LUFTFILTER</p> <p>H : 194 / 175 mm Ø : 135 / 130 mm ø : 80 mm</p> 
<p>SA 7954</p> <p>FILTRE A AIR AIR FILTER LUFTFILTER</p> <p>H : 55 / 34 mm L : 200 mm I : 200 mm</p> 	<p>SA 7970</p> <p>FILTRE A AIR AIR FILTER LUFTFILTER</p> <p>H : 77 / 75 mm Ø : 189 mm ø : 153 mm</p> 	<p>SA 8998</p> <p>FILTRE A AIR AIR FILTER LUFTFILTER</p> <p>H : 85 / 76 mm Ø : 120.5 mm ø : 86 / 86 mm</p> 

MOTONEIGES - QUADS | SNOWMOBILE - ATV | SCHNEEMOBIL - QUADS











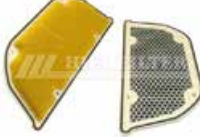

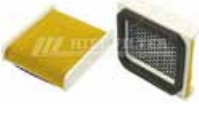

<p>HONDA MOTO</p> <p>SO 6076 FILTRE A HUILE OIL FILTER OELFILTER</p>  <p>H : 57 mm Ø : 76 mm ø : 20 / 20 mm</p>	<p>HONDA MOTO</p> <p>SO 6993 FILTRE A HUILE OIL FILTER OELFILTER</p>  <p>H : 45 mm Ø : 69 mm ø : 20 / 20 mm</p>	<p>HUSABERG</p> <p>SO 6959 FILTRE A HUILE OIL FILTER OELFILTER</p>  <p>H : 86.5 / 84 mm Ø : 33.5 mm ø : 12 mm</p>
<p>SO 6929 FILTRE A HUILE OIL FILTER OELFILTER</p>  <p>H : 46.5 / 45.5 mm Ø : 69 mm ø : 20 mm</p>	<p>SO 6994 FILTRE A HUILE OIL FILTER OELFILTER</p>  <p>H : 38 / 36 mm Ø : 50 mm ø : 12.5 mm</p>	<p>SO 7095 FILTRE A HUILE OIL FILTER OELFILTER</p>  <p>H : 70 / 68 mm Ø : 42 mm ø : 11.5 mm</p>
<p>SO 6955 FILTRE A HUILE OIL FILTER OELFILTER</p>  <p>H : 66 / 64 mm Ø : 68 / 65 mm ø : M20X1,5</p>	<p>T 59 FILTRE A HUILE OIL FILTER OELFILTER</p>  <p>H : 73 / 72 mm Ø : 68 / 65 mm ø : M20X1,5</p>	<p>HUSQVARNA</p> <p>SO 6962 FILTRE A HUILE OIL FILTER OELFILTER</p>  <p>H : 87 / 85 mm Ø : 42 mm ø : 12 mm</p>
<p>SO 6956 FILTRE A HUILE OIL FILTER OELFILTER</p>  <p>H : 38 / 36 mm Ø : 40 / 38 mm ø : 8 mm</p>	<p>T 8304 FILTRE A HUILE OIL FILTER OELFILTER</p>  <p>H : 83 / 81 mm Ø : 83 / 80 mm ø : M20X1,5</p>	<p>SO 6980 FILTRE A HUILE OIL FILTER OELFILTER</p>  <p>H : 35 / 33 mm Ø : 38 mm ø : 11 mm</p>
<p>SO 6966 FILTRE A HUILE OIL FILTER OELFILTER</p>  <p>H : 48 / 46 mm Ø : 47 / 41 mm ø : 10 mm</p>	<p>HSUN</p> <p>SO 6986 FILTRE A HUILE OIL FILTER OELFILTER</p>  <p>H : 74 / 70 mm Ø : 56 mm ø : 25 mm</p>	<p>HUSQVARNA MOTO</p> <p>SO 6948 FILTRE A HUILE OIL FILTER OELFILTER</p>  <p>H : 48 / 45 mm Ø : 45 mm ø : 17 mm</p>
<p>SO 6980 FILTRE A HUILE OIL FILTER OELFILTER</p>  <p>H : 35 / 33 mm Ø : 38 mm ø : 11 mm</p>	<p>HUSABERG</p> <p>SA 7808 FILTRE A AIR AIR FILTER LUFTFILTER</p>  <p>H : 84 mm Ø : 217 / 210 mm</p>	<p>HYOSUNG</p> <p>SO 6926 FILTRE A HUILE OIL FILTER OELFILTER</p>  <p>H : 60 mm Ø : 60 mm ø : 17 mm</p>



MOTONEIGES - QUADS | SNOWMOBILE - ATV | SCHNEEMOBIL - QUADS



















HYOSUNG	ITALJET	KAWASAKI MOTO
<p>SO 6975 FILTRE A HUILE OIL FILTER OELFILTER</p> <p>H : 40 mm Ø : 44 mm ø : 13.5 mm</p> 	<p>SA 7982 FILTRE A AIR AIR FILTER LUFTFILTER</p> <p>H : 40 mm L : 152 mm l : 113 mm</p> 	<p>SA 12317 FILTRE A AIR AIR FILTER LUFTFILTER</p> <p>H : 113 / 99 mm Ø : 128 mm ø : 72 mm</p> 
<p>T 501 FILTRE A HUILE OIL FILTER OELFILTER</p> <p>H : 68 / 67 mm Ø : 71 / 68 mm ø : 3/4"-16UNF</p> 	<p>SO 6967 FILTRE A HUILE OIL FILTER OELFILTER</p> <p>H : 67 / 65 mm Ø : 55 / 52 mm ø : M14X1,5</p> 	<p>SA 7781 FILTRE A AIR AIR FILTER LUFTFILTER</p> <p>H : 35 mm L : 276 mm l : 196 mm</p> 
HYTRACK		
<p>SA 28995 FILTRE A AIR AIR FILTER LUFTFILTER</p> <p>H : 210 mm Ø : 115 mm ø : 63 / 63 / 0 mm</p> 	<p>SO 6968 FILTRE A HUILE OIL FILTER OELFILTER</p> <p>H : 35 mm Ø : 33 mm ø : 20 mm</p> 	<p>SA 7783 FILTRE A AIR AIR FILTER LUFTFILTER</p> <p>H : 48 mm L : 275 mm l : 125 mm</p> 
<p>SO 6924 FILTRE A HUILE OIL FILTER OELFILTER</p> <p>H : 84 / 83 mm Ø : 67 / 60 mm ø : M18X1,5</p> 	<p>SO 6982 FILTRE A HUILE OIL FILTER OELFILTER</p> <p>H : 42 / 32 mm Ø : 42 mm ø : 14 / 14 mm</p> 	<p>SA 7834 FILTRE A AIR AIR FILTER LUFTFILTER</p> <p>H : 91 / 81 mm Ø : 130 / 120 / 110 mm ø : 90 / 80 mm</p> 
<p>T 501 FILTRE A HUILE OIL FILTER OELFILTER</p> <p>H : 68 / 67 mm Ø : 71 / 68 mm ø : 3/4"-16UNF</p> 	<p>SO 8996 FILTRE A HUILE OIL FILTER OELFILTER</p> <p>H : 58 / 51 mm Ø : 50 mm ø : 14 / 14 mm</p> 	<p>SA 7892 FILTRE A AIR AIR FILTER LUFTFILTER</p> <p>H : 90 mm Ø : 179 mm</p> 
ITALJET	JOHN DEERE	
<p>SA 7971 FILTRE A AIR AIR FILTER LUFTFILTER</p> <p>H : 15 mm L : 285 mm l : 170 mm</p> 	<p>SA 8984 FILTRE A AIR AIR FILTER LUFTFILTER</p> <p>H : 131 / 115 mm Ø : 110 mm ø : 72 mm</p> 	<p>SA 7895 FILTRE A AIR AIR FILTER LUFTFILTER</p> <p>H : 72 mm Ø : 306 / 72 mm</p> 

MOTONEIGES - QUADS | SNOWMOBILE - ATV | SCHNEEMOBIL - QUADS



















KAWASAKI MOTO	KAWASAKI MOTO	KAWASAKI MOTO
<p>SA 7898 FILTRE A AIR AIR FILTER LUFTFILTER</p>  <p>H : 28 / 18 mm L : 300 / 274 mm I : 152 / 140 mm</p>	<p>SA 7963 FILTRE A AIR AIR FILTER LUFTFILTER</p>  <p>H : 17 mm L : 312 mm I : 134 mm</p>	<p>SA 8976 FILTRE A AIR AIR FILTER LUFTFILTER</p>  <p>H : 138 / 137 mm Ø : 110 / 108 mm ø : 74 mm</p>
<p>SA 7899 FILTRE A AIR AIR FILTER LUFTFILTER</p>  <p>H : 78 / 70 mm Ø : 144 / 90 mm</p>	<p>SA 7964 FILTRE A AIR AIR FILTER LUFTFILTER</p>  <p>H : 22 / 16 mm L : 199 / 194 mm I : 154 mm</p>	<p>SO 6066 FILTRE A HUILE OIL FILTER OELFILTER</p>  <p>H : 82 mm Ø : 80 mm ø : 20 / 20 mm</p>
<p>SA 7900 FILTRE A AIR AIR FILTER LUFTFILTER</p>  <p>H : 39 / 29 mm Ø : 138 / 120 mm</p>	<p>SA 7965 FILTRE A AIR AIR FILTER LUFTFILTER</p>  <p>H : 81 / 71 mm Ø : 142 / 91 mm ø : 96.5 / 61.5 mm</p>	<p>SO 6076 FILTRE A HUILE OIL FILTER OELFILTER</p>  <p>H : 57 mm Ø : 76 mm ø : 20 / 20 mm</p>
<p>SA 7901 FILTRE A AIR AIR FILTER LUFTFILTER</p>  <p>H : 180 / 160 mm Ø : 101 / 90 mm ø : 60 / 60 mm</p>	<p>SA 7973 FILTRE A AIR AIR FILTER LUFTFILTER</p>  <p>H : 81 / 76 mm Ø : 135 / 103 mm ø : 123 / 91 mm</p>	<p>SO 6955 FILTRE A HUILE OIL FILTER OELFILTER</p>  <p>H : 66 / 64 mm Ø : 68 / 65 mm ø : M20X1,5</p>
<p>SA 7939 FILTRE A AIR AIR FILTER LUFTFILTER</p>  <p>H : 18 mm L : 299 mm I : 169 mm</p>	<p>SA 8973 FILTRE A AIR AIR FILTER LUFTFILTER</p>  <p>H : 100 mm Ø : 175 mm ø : 150 / 125 mm</p>	<p>SO 6974 FILTRE A HUILE OIL FILTER OELFILTER</p>  <p>H : 44 / 42 mm Ø : 38 mm ø : 10.5 mm</p>
<p>SA 7962 FILTRE A AIR AIR FILTER LUFTFILTER</p>  <p>H : 22 mm L : 344 / 317 mm I : 157 mm</p>	<p>SA 8974 FILTRE A AIR AIR FILTER LUFTFILTER</p>  <p>H : 98 / 90 mm Ø : 240 mm ø : 182 / 86 mm</p>	<p>SO 6976 FILTRE A HUILE OIL FILTER OELFILTER</p>  <p>H : 53 mm Ø : 55 mm ø : 17 / 17 mm</p>



MOTONEIGES - QUADS | SNOWMOBILE - ATV | SCHNEEMOBIL - QUADS

KAWASAKI MOTO	KAWASAKI MOTO	KTM
<p>SO 6979 FILTRE A HUILE OIL FILTER OELFILTER</p> <p>H : 44 mm Ø : 44 mm ø : 13.5 mm</p> 	<p>T 501 FILTRE A HUILE OIL FILTER OELFILTER</p> <p>H : 68 / 67 mm Ø : 71 / 68 mm ø : 3/4"-16UNF</p> 	<p>SA 7808 FILTRE A AIR AIR FILTER LUFTFILTER</p> <p>H : 84 mm Ø : 217 / 210 mm</p> 
<p>SO 6988 FILTRE A HUILE OIL FILTER OELFILTER</p> <p>H : 55 mm Ø : 44 mm ø : 13.5 mm</p> 	<p>T 59 FILTRE A HUILE OIL FILTER OELFILTER</p> <p>H : 73 / 72 mm Ø : 68 / 65 mm ø : M20X1,5</p> 	<p>SA 7938 FILTRE A AIR AIR FILTER LUFTFILTER</p> <p>H : 70 mm Ø : 161 / 137 mm ø : 115 / 77 mm</p> 
<p>SO 6994 FILTRE A HUILE OIL FILTER OELFILTER</p> <p>H : 38 / 36 mm Ø : 50 mm ø : 12.5 mm</p> 	<p>T 8304 FILTRE A HUILE OIL FILTER OELFILTER</p> <p>H : 83 / 81 mm Ø : 83 / 80 mm ø : M20X1,5</p> 	<p>SO 6941 FILTRE A HUILE OIL FILTER OELFILTER</p> <p>H : 53 / 49 mm Ø : 42 mm ø : 12 / 12 mm</p> 
<p>SO 6995 FILTRE A HUILE OIL FILTER OELFILTER</p> <p>H : 55 / 52 mm Ø : 55 mm ø : 14 / 14 mm</p> 	<p>KTM SA 5109 KIT KIT FILTRE A AIR AIR FILTER KIT LUFTFILTER-KIT</p> <p>H : 50 mm L : 185 mm l : 138 mm</p> 	<p>SO 6959 FILTRE A HUILE OIL FILTER OELFILTER</p> <p>H : 86.5 / 84 mm Ø : 33.5 mm ø : 12 mm</p> 
<p>SO 6999 FILTRE A HUILE OIL FILTER OELFILTER</p> <p>H : 66 / 65 mm Ø : 71 / 68 mm ø : M20X1</p> 	<p>SA 5138 FILTRE A AIR AIR FILTER LUFTFILTER</p> <p>H : 46 mm L : 365 mm l : 156.5 mm</p> 	<p>SO 6960 FILTRE A HUILE OIL FILTER OELFILTER</p> <p>H : 130 / 128 mm Ø : 41 mm ø : 12 mm</p> 
<p>T 1636 FILTRE A HUILE OIL FILTER OELFILTER</p> <p>H : 73 / 71 mm Ø : 69 / 65 mm ø : 3/4"-16UNF</p> 	<p>SA 7782 FILTRE A AIR AIR FILTER LUFTFILTER</p> <p>H : 41 mm L : 128 mm l : 108 mm</p> 	<p>SO 6972 FILTRE A HUILE OIL FILTER OELFILTER</p> <p>H : 77 / 76 mm Ø : 68 / 66 mm ø : M20X1,5</p> 

MOTONEIGES - QUADS | SNOWMOBILE - ATV | SCHNEEMOBIL - QUADS

KTM	KYMCO	LAVERDA MOTO
<p>SO 6985 FILTRE A HUILE OIL FILTER OELFILTER</p> <p>H : 52 / 49 mm Ø : 42 mm ø : 11.5 mm</p> 	<p>SO 6938 FILTRE A HUILE OIL FILTER OELFILTER</p> <p>H : 43 / 41 mm Ø : 44 mm ø : 12 mm</p> 	<p>SA 275 FILTRE A AIR AIR FILTER LUFTFILTER</p> <p>H : 41 / 39 mm Ø : 140 mm ø : 52 / 52 mm</p> 
<p>SO 7095 FILTRE A HUILE OIL FILTER OELFILTER</p> <p>H : 70 / 68 mm Ø : 42 mm ø : 11.5 mm</p> 	<p>SO 6969 FILTRE A HUILE OIL FILTER OELFILTER</p> <p>H : 52 / 50 mm Ø : 72 / 68 mm ø : M20X1,5</p> 	<p>LINHAI</p> <p>SA 8971 FILTRE A AIR AIR FILTER LUFTFILTER</p> <p>H : 210 mm Ø : 100 mm ø : 75 mm</p> 
<p>SO 7110 FILTRE A HUILE OIL FILTER OELFILTER</p> <p>H : 51 / 47 mm Ø : 56 mm ø : 25 mm</p> 	<p>SO 6971 FILTRE A HUILE OIL FILTER OELFILTER</p> <p>H : 77 / 73 mm Ø : 42 mm ø : 13 mm</p> 	<p>MALAGUTI</p> <p>SA 312 FILTRE A AIR AIR FILTER LUFTFILTER</p> <p>H : 48 mm L : 199 mm l : 93 mm</p> 
<p>KYMCO</p> <p>SA 7551 FILTRE A AIR AIR FILTER LUFTFILTER</p> <p>H : 32 / 18 mm L : 186 / 156 mm l : 83 / 69 mm</p> 	<p>SO 6999 FILTRE A HUILE OIL FILTER OELFILTER</p> <p>H : 66 / 65 mm Ø : 71 / 68 mm ø : M20X1</p> 	<p>SO 131 FILTRE A HUILE OIL FILTER OELFILTER</p> <p>H : 60 / 58 mm Ø : 78 / 75.5 mm ø : 3/4"-16UNF</p> 
<p>SA 7940 FILTRE A AIR AIR FILTER LUFTFILTER</p> <p>H : 146 / 0 mm Ø : 86 / 64 mm ø : 60 / 0 mm</p> 	<p>LAVERDA</p> <p>SA 11112 FILTRE A AIR AIR FILTER LUFTFILTER</p> <p>H : 70 mm Ø : 97.5 mm ø : 60 / 60 mm</p> 	<p>SO 6967 FILTRE A HUILE OIL FILTER OELFILTER</p> <p>H : 67 / 65 mm Ø : 55 / 52 mm ø : M14X1,5</p> 
<p>SA 8972 FILTRE A AIR AIR FILTER LUFTFILTER</p> <p>H : 137 / 120 mm Ø : 89 / 73 mm ø : 45 mm</p> 	<p>SO 131 FILTRE A HUILE OIL FILTER OELFILTER</p> <p>H : 60 / 58 mm Ø : 78 / 75.5 mm ø : 3/4"-16UNF</p> 	<p>MASSEY FERGUSON</p> <p>SA 10793 FILTRE A AIR AIR FILTER LUFTFILTER</p> <p>H : 50 / 50 mm Ø : 152 mm ø : 118 / 118 mm</p> <p>PREFILTER/VORFILTER: SA 20793</p> 



MOTONEIGES - QUADS | SNOWMOBILE - ATV | SCHNEEMOBIL - QUADS





















<p>MASSEY FERGUSON</p> <p>SA 8991 FILTRE A AIR AIR FILTER LUFTFILTER</p>  <p>H : 134 / 117 mm Ø : 120 mm ø : 73 mm</p>	<p>MORINI</p> <p>SO 6953 FILTRE A HUILE OIL FILTER OELFILTER</p>  <p>H : 58 mm Ø : 50 mm ø : 18 mm</p>	<p>MOTO GUZZI</p> <p>SA 218 FILTRE A AIR AIR FILTER LUFTFILTER</p>  <p>H : 57 / 51 mm Ø : 173 mm ø : 128 / 128 mm</p>
<p>MBK</p> <p>SA 7977 FILTRE A AIR AIR FILTER LUFTFILTER</p>  <p>H : 93 / 83 mm Ø : 102 mm ø : 52 / 52 mm</p>	<p>MOTO GUZZI</p> <p>BE 5 FILTRE A ESSENCE PETROL FILTER BENZINFILTER</p>  <p>H : 133 / 108 mm Ø : 62 mm ø : M14X1,5 / M12X1,5</p>	<p>SA 5163 FILTRE A AIR AIR FILTER LUFTFILTER</p>  <p>H : 54 mm L : 126 mm l : 81 mm</p>
<p>SO 6989 FILTRE A HUILE OIL FILTER OELFILTER</p>  <p>H : 48 / 44 mm Ø : 38 mm ø : 12.5 mm</p>	<p>SA 10331 FILTRE A AIR AIR FILTER LUFTFILTER</p>  <p>H : 83 mm Ø : 110 mm ø : 76 / 76 mm</p>	<p>SA 7011 FILTRE A AIR AIR FILTER LUFTFILTER</p>  <p>H : 193 mm Ø : 75 / 57 mm ø : 55 / 21 mm</p>
<p>MINICO</p> <p>SA 8971 FILTRE A AIR AIR FILTER LUFTFILTER</p>  <p>H : 210 mm Ø : 100 mm ø : 75 mm</p>	<p>SA 12832 FILTRE A AIR AIR FILTER LUFTFILTER</p>  <p>H : 30 mm L : 190 mm l : 80 mm</p>	<p>SA 7056 FILTRE A AIR AIR FILTER LUFTFILTER</p>  <p>H : 36 mm L : 226 mm l : 135 mm</p>
<p>MORINI</p> <p>SA 7984 FILTRE A AIR AIR FILTER LUFTFILTER</p>  <p>H : 50 mm Ø : 85 mm ø : 60 / 60 mm</p>	<p>SA 12922 FILTRE A AIR AIR FILTER LUFTFILTER</p>  <p>H : 27 mm L : 154 mm l : 115 mm</p>	<p>SA 7076 FILTRE A AIR AIR FILTER LUFTFILTER</p>  <p>H : 58 mm L : 276 mm l : 97 mm</p>
<p>SA 7985 FILTRE A AIR AIR FILTER LUFTFILTER</p>  <p>H : 135 mm Ø : 86 mm ø : 60 / 60 mm</p>	<p>SA 1452 FILTRE A AIR AIR FILTER LUFTFILTER</p>  <p>H : 49 mm L : 222 mm l : 135 mm</p>	<p>SA 7975 FILTRE A AIR AIR FILTER LUFTFILTER</p>  <p>H : 24 / 15 mm L : 183 mm l : 128 mm</p>

MOTONEIGES - QUADS | SNOWMOBILE - ATV | SCHNEEMOBIL - QUADS

















MOTO GUZZI	MOTO GUZZI	MV AGUSTA
<p>SA 7976 FILTRE A AIR AIR FILTER LUFTFILTER</p> <p>H : 108 mm Ø : 130 mm ø : 98 / 98 mm</p> 	<p>SO 4126 FILTRE A HUILE OIL FILTER OELFILTER</p> <p>H : 81 / 79 mm Ø : 71 mm ø : 21 / 21 mm</p> 	<p>SO 6944 FILTRE A HUILE OIL FILTER OELFILTER</p> <p>H : 67 / 65 mm Ø : 67 / 65 mm ø : M20X1,5</p> 
<p>SA 7982 FILTRE A AIR AIR FILTER LUFTFILTER</p> <p>H : 40 mm L : 152 mm I : 113 mm</p> 	<p>SO 6076 FILTRE A HUILE OIL FILTER OELFILTER</p> <p>H : 57 mm Ø : 76 mm ø : 20 / 20 mm</p> 	<p>SO 6955 FILTRE A HUILE OIL FILTER OELFILTER</p> <p>H : 66 / 64 mm Ø : 68 / 65 mm ø : M20X1,5</p> 
<p>SA 807 FILTRE A AIR AIR FILTER LUFTFILTER</p> <p>H : 142 / 129 mm Ø : 76 mm ø : 42 mm</p> 	<p>SO 8003 FILTRE A HUILE OIL FILTER OELFILTER</p> <p>H : 61 / 59 mm Ø : 78 / 76 mm ø : M16X1,5</p> 	<p>MZ</p> <p>SA 7881 FILTRE A AIR AIR FILTER LUFTFILTER</p> <p>H : 37 / 27 mm L : 142 mm I : 130 mm</p> 
<p>SN 20759 FILTRE A GASOIL FUEL FILTER KRAFTSTOFF-FILTER</p> <p>H : 93 mm Ø : 51 / 50 mm ø : 8 / 8 mm</p> 	<p>SO 8023 FILTRE A HUILE OIL FILTER OELFILTER</p> <p>H : 122 / 102 mm Ø : 45 mm ø : 17 / 8 mm</p> 	<p>SO 6990 FILTRE A HUILE OIL FILTER OELFILTER</p> <p>H : 61 / 51 mm Ø : 55 mm ø : 18 mm</p> 
<p>SO 131 FILTRE A HUILE OIL FILTER OELFILTER</p> <p>H : 60 / 58 mm Ø : 78 / 75.5 mm ø : 3/4"-16UNF</p> 	<p>MUZ</p> <p>SO 7110 FILTRE A HUILE OIL FILTER OELFILTER</p> <p>H : 51 / 47 mm Ø : 56 mm ø : 25 mm</p> 	<p>SO 7110 FILTRE A HUILE OIL FILTER OELFILTER</p> <p>H : 51 / 47 mm Ø : 56 mm ø : 25 mm</p> 
<p>SO 3335 FILTRE A HUILE OIL FILTER OELFILTER</p> <p>H : 88 / 86 mm Ø : 78 / 76 mm ø : 3/4"-16UNF</p> 	<p>MV AGUSTA</p> <p>SO 6928 FILTRE A HUILE OIL FILTER OELFILTER</p> <p>H : 52 / 47 mm Ø : 57 mm ø : 17 mm</p> 	<p>SO 9001 FILTRE A HUILE OIL FILTER OELFILTER</p> <p>H : 78 / 77 mm Ø : 79 / 77 mm ø : 3/4"-16UNF</p> 

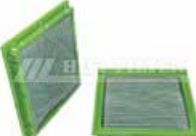

MOTONEIGES - QUADS | SNOWMOBILE - ATV | SCHNEEMOBIL - QUADS

















<p>NORTON MOTO</p> <p>HR 6097 FILTRE A AIR AIR FILTER LUFTFILTER</p>  <p>H : 72.5 mm Ø : 212 mm ø : 176 / 167 mm</p> <p>NORTON MOTO</p>	<p>PIAGGIO</p> <p>SA 7795 FILTRE AAIR AIR FILTER LUFTFILTER</p>  <p>H : 20 mm L : 208 mm I : 185 mm</p>	<p>PIAGGIO</p> <p>T 501 FILTRE A HUILE OIL FILTER OELFILTER</p>  <p>H : 68 / 67 mm Ø : 71 / 68 mm ø : 3/4"-16UNF</p>	
<p>SO 129 FILTRE A HUILE OIL FILTER OELFILTER</p>  <p>H : 74 / 72 mm Ø : 79 / 76 mm ø : M16X1,5</p>	<p>SA 7971 FILTRE AAIR AIR FILTER LUFTFILTER</p>  <p>H : 15 mm L : 285 mm I : 170 mm</p>	<p>POLARIS</p> <p>SA 12068 FILTRE A AIR AIR FILTER LUFTFILTER</p>  <p>H : 120 mm Ø : 111 mm ø : 77 / 77 mm</p>	
<p>PEUGEOT MOTOCYCLES</p>			<p>SA 12156 FILTRE A AIR AIR FILTER LUFTFILTER</p>  <p>H : 72.5 mm Ø : 142 / 98 mm ø : 94 / 50 / 8 mm</p> <p>PREFILTER/VORFILTER: SA 22157</p>
<p>SA 4019 FILTRE A AIR AIR FILTER LUFTFILTER</p>  <p>H : 40 mm L : 205 mm I : 169 mm</p>	<p>SO 131 FILTRE A HUILE OIL FILTER OELFILTER</p>  <p>H : 60 / 58 mm Ø : 78 / 75.5 mm ø : 3/4"-16UNF</p>	<p>SA 16074 FILTRE A AIR AIR FILTER LUFTFILTER</p>  <p>H : 274 / 267 mm Ø : 105 mm ø : 62.5 mm</p>	
<p>SO 6955 FILTRE A HUILE OIL FILTER OELFILTER</p>  <p>H : 66 / 64 mm Ø : 68 / 65 mm ø : M20X1,5</p>	<p>SO 6961 FILTRE A HUILE OIL FILTER OELFILTER</p>  <p>H : 49 / 47 mm Ø : 45 mm ø : 14 mm</p>	<p>SA 28995 FILTRE A AIR AIR FILTER LUFTFILTER</p>  <p>H : 210 mm Ø : 115 mm ø : 63 / 63 / 0 mm</p>	
<p>PGO</p>			<p>SA 7555 FILTRE A AIR AIR FILTER LUFTFILTER</p>  <p>H : 46 mm L : 285 mm I : 208 mm</p>
<p>SO 6967 FILTRE A HUILE OIL FILTER OELFILTER</p>  <p>H : 67 / 65 mm Ø : 55 / 52 mm ø : M14X1,5</p>	<p>SO 6967 FILTRE A HUILE OIL FILTER OELFILTER</p>  <p>H : 67 / 65 mm Ø : 55 / 52 mm ø : M14X1,5</p>	<p>PIAGGIO</p> <p>SA 4019 FILTRE A AIR AIR FILTER LUFTFILTER</p>  <p>H : 40 mm L : 205 mm I : 169 mm</p>	
<p>SA 4019 FILTRE A AIR AIR FILTER LUFTFILTER</p>  <p>H : 40 mm L : 205 mm I : 169 mm</p>	<p>SO 6968 FILTRE A HUILE OIL FILTER OELFILTER</p>  <p>H : 35 mm Ø : 33 mm ø : 20 mm</p>	<p>SA 7555 FILTRE A AIR AIR FILTER LUFTFILTER</p>  <p>H : 46 mm L : 285 mm I : 208 mm</p>	

MOTONEIGES - QUADS | SNOWMOBILE - ATV | SCHNEEMOBIL - QUADS



















POLARIS	POLARIS	POLARIS
<p>SA 7812 FILTRE A AIR AIR FILTER LUFTFILTER</p> <p>H : 275 / 265 mm Ø : 105 mm ø : 65 / 60 mm</p> 	<p>SN 20106 FILTRE A GASOIL FUEL FILTER KRAFTSTOFF-FILTER</p> <p>H : 54 / 25 mm Ø : 22 mm ø : 6.5 / 6.5 mm</p> <p>75µ</p> 	<p>SO 6943 FILTRE A HUILE OIL FILTER OELFILTER</p> <p>H : 87 / 85 mm Ø : 68 / 65 mm ø : M20X1,5</p> 
<p>SA 8955 FILTRE A AIR AIR FILTER LUFTFILTER</p> <p>H : 210 / 178 mm Ø : 140 mm ø : 63 mm</p> 	<p>SN 21581 FILTRE A GASOIL FUEL FILTER KRAFTSTOFF-FILTER</p> <p>H : 50.5 / 47.5 mm Ø : 35 mm ø : 11.2 mm</p> 	<p>SO 6967 FILTRE A HUILE OIL FILTER OELFILTER</p> <p>H : 67 / 65 mm Ø : 55 / 52 mm ø : M14X1,5</p> 
<p>SA 8970 FILTRE A AIR AIR FILTER LUFTFILTER</p> <p>H : 144 / 131 mm Ø : 99 mm ø : 49 mm</p> 	<p>SN 24632 FILTRE A GASOIL FUEL FILTER KRAFTSTOFF-FILTER</p> <p>H : 105 / 58 mm Ø : 59 / 49 mm ø : 6.5 / 0 mm</p> 	<p>SO 6973 FILTRE A HUILE OIL FILTER OELFILTER</p> <p>H : 55 / 53 mm Ø : 78 / 76 mm ø : 3/4"-16UNF</p> 
<p>SA 8992 FILTRE A AIR AIR FILTER LUFTFILTER</p> <p>H : 24 mm L : 213 mm I : 212 mm</p> 	<p>SN 25027 FILTRE A GASOIL FUEL FILTER KRAFTSTOFF-FILTER</p> <p>H : 82 / 81 mm Ø : 93 / 90 mm ø : M20X1,5</p> 	<p>SO 6980 FILTRE A HUILE OIL FILTER OELFILTER</p> <p>H : 35 / 33 mm Ø : 38 mm ø : 11 mm</p> 
<p>SA 8994 FILTRE A AIR AIR FILTER LUFTFILTER</p> <p>H : 133 / 119 mm Ø : 116 / 103 mm ø : 64 mm</p> 	<p>SN 40772 FILTRE A GASOIL SEPARATEUR D'EAU FUEL WATER SEPARATOR FILTER ABSCHIEDER DIESELFILTER</p> <p>H : 103 mm Ø : 77 / 77 mm ø : M18X1,5</p> 	<p>SO 6985 FILTRE A HUILE OIL FILTER OELFILTER</p> <p>H : 52 / 49 mm Ø : 42 mm ø : 11.5 mm</p> 
<p>SA 8995 FILTRE A AIR AIR FILTER LUFTFILTER</p> <p>H : 210 / 181 mm Ø : 103 mm ø : 63 mm</p> 	<p>SO 6942 FILTRE A HUILE OIL FILTER OELFILTER</p> <p>H : 70 mm Ø : 46 mm ø : 17 / 16 mm</p> 	<p>SO 6994 FILTRE A HUILE OIL FILTER OELFILTER</p> <p>H : 38 / 36 mm Ø : 50 mm ø : 12.5 mm</p> 



MOTONEIGES - QUADS | SNOWMOBILE - ATV | SCHNEEMOBIL - QUADS

<p>POLARIS</p> <p>SO 7095 FILTRE A HUILE OIL FILTER OELFILTER</p> <p>H : 70 / 68 mm Ø : 42 mm ø : 11.5 mm</p> 	<p>ROTAX</p> <p>SO 6983 FILTRE A HUILE OIL FILTER OELFILTER</p> <p>H : 74 / 73 mm Ø : 88 / 87 mm ø : 3/4"-16UNF</p> 	<p>SUZUKI MOTO</p> <p>SA 12268 FILTRE A AIR AIR FILTER LUFTFILTER</p> <p>H : 115 mm Ø : 101 mm ø : 40 / 2 mm</p> 
<p>T 59 FILTRE A HUILE OIL FILTER OELFILTER</p> <p>H : 73 / 72 mm Ø : 68 / 65 mm ø : M20X1,5</p> 	<p>SACHS</p> <p>SO 6990 FILTRE A HUILE OIL FILTER OELFILTER</p> <p>H : 61 / 51 mm Ø : 55 mm ø : 18 mm</p> 	<p>SA 12336 FILTRE A AIR AIR FILTER LUFTFILTER</p> <p>H : 88 mm Ø : 98 mm ø : 37 / 7 mm</p> 
<p>T 600 FILTRE A HUILE OIL FILTER OELFILTER</p> <p>H : 67 / 65 mm Ø : 71 / 68 mm ø : M20X1,5</p> 	<p>SEA DOO</p> <p>SO 6977 FILTRE A HUILE OIL FILTER OELFILTER</p> <p>H : 106 / 99 mm Ø : 56 mm ø : 25 / 25 mm</p> 	<p>SA 12337 FILTRE A AIR AIR FILTER LUFTFILTER</p> <p>H : 88 mm Ø : 148 mm ø : 78 / 6 mm</p> 
<p>ROTAX</p> <p>SO 131 FILTRE A HUILE OIL FILTER OELFILTER</p> <p>H : 60 / 58 mm Ø : 78 / 75.5 mm ø : 3/4"-16UNF</p> 	<p>SHERCO</p> <p>SO 6962 FILTRE A HUILE OIL FILTER OELFILTER</p> <p>H : 87 / 85 mm Ø : 42 mm ø : 12 mm</p> 	<p>SA 2089 FILTRE A AIR AIR FILTER LUFTFILTER</p> <p>H : 19 mm L : 247 mm I : 234 mm</p> 
<p>SO 6935 FILTRE A HUILE OIL FILTER OELFILTER</p> <p>H : 100 / 97 mm Ø : 57 mm ø : 25 mm</p> 	<p>SUMICO</p> <p>SA 8987 FILTRE A AIR AIR FILTER LUFTFILTER</p> <p>H : 155 / 150 mm Ø : 89 mm ø : 58 mm</p> 	<p>SA 2095 FILTRE A AIR AIR FILTER LUFTFILTER</p> <p>H : 18 mm L : 289 mm I : 178 mm</p> 
<p>SO 6977 FILTRE A HUILE OIL FILTER OELFILTER</p> <p>H : 106 / 99 mm Ø : 56 mm ø : 25 / 25 mm</p> 	<p>SUZUKI MOTO</p> <p>SA 12203 FILTRE A AIR AIR FILTER LUFTFILTER</p> <p>H : 130 mm Ø : 120 mm ø : 60 / 2 mm</p> 	<p>SA 7799 FILTRE A AIR AIR FILTER LUFTFILTER</p> <p>H : 27 / 19 mm L : 192 mm I : 171 mm</p> 

MOTONEIGES - QUADS | SNOWMOBILE - ATV | SCHNEEMOBIL - QUADS



















SUZUKI MOTO	SUZUKI MOTO	SUZUKI MOTO
<p>SA 7803</p> <p>FILTRE A AIR AIR FILTER LUFTFILTER</p>  <p>H : 125 mm Ø : 147 / 123 mm ø : 80 / 55 mm</p>	<p>SA 7928</p> <p>FILTRE A AIR AIR FILTER LUFTFILTER</p>  <p>H : 108 / 102 mm Ø : 170 / 112 mm ø : 157 / 98 mm</p>	<p>SO 6974</p> <p>FILTRE A HUILE OIL FILTER OELFILTER</p>  <p>H : 44 / 42 mm Ø : 38 mm ø : 10.5 mm</p>
<p>SA 7844</p> <p>FILTRE A AIR AIR FILTER LUFTFILTER</p>  <p>H : 48 / 41 mm Ø : 218.5 / 191 / 86 mm</p>	<p>SA 7935</p> <p>FILTRE A AIR AIR FILTER LUFTFILTER</p>  <p>H : 20 mm L : 269 mm I : 173 mm</p>	<p>SO 6975</p> <p>FILTRE A HUILE OIL FILTER OELFILTER</p>  <p>H : 40 mm Ø : 44 mm ø : 13.5 mm</p>
<p>SA 7850</p> <p>FILTRE A AIR AIR FILTER LUFTFILTER</p>  <p>H : 125 / 103 mm Ø : 153 / 152 mm ø : 45 mm</p>	<p>SA 7960</p> <p>FILTRE A AIR AIR FILTER LUFTFILTER</p>  <p>H : 24 mm L : 210 mm I : 191.5 mm</p>	<p>SO 6979</p> <p>FILTRE A HUILE OIL FILTER OELFILTER</p>  <p>H : 44 mm Ø : 44 mm ø : 13.5 mm</p>
<p>SA 7854</p> <p>FILTRE A AIR AIR FILTER LUFTFILTER</p>  <p>H : 177 / 138 mm Ø : 151 / 135 mm ø : 55 mm</p>	<p>SA 7961</p> <p>FILTRE A AIR AIR FILTER LUFTFILTER</p>  <p>H : 142 / 130 mm Ø : 126 / 112 / 84 mm ø : 48 mm</p>	<p>SO 6988</p> <p>FILTRE A HUILE OIL FILTER OELFILTER</p>  <p>H : 55 mm Ø : 44 mm ø : 13.5 mm</p>
<p>SA 7857</p> <p>FILTRE A AIR AIR FILTER LUFTFILTER</p>  <p>H : 110 / 91 mm Ø : 144 / 88 mm ø : 69 mm</p>	<p>SA 8975</p> <p>FILTRE A AIR AIR FILTER LUFTFILTER</p>  <p>H : 133 / 111 mm Ø : 120 mm ø : 76 mm</p>	<p>SO 6994</p> <p>FILTRE A HUILE OIL FILTER OELFILTER</p>  <p>H : 38 / 36 mm Ø : 50 mm ø : 12.5 mm</p>
<p>SA 7879</p> <p>FILTRE A AIR AIR FILTER LUFTFILTER</p>  <p>H : 89 mm Ø : 243 / 182 mm</p>	<p>SO 6925</p> <p>FILTRE A HUILE OIL FILTER OELFILTER</p>  <p>H : 43 / 40 mm Ø : 38 mm ø : 12 mm</p>	<p>SO 6996</p> <p>FILTRE A HUILE OIL FILTER OELFILTER</p>  <p>H : 65 mm Ø : 72 mm ø : 20 mm</p>



MOTONEIGES - QUADS | SNOWMOBILE - ATV | SCHNEEMOBIL - QUADS



















<p>SUZUKI MOTO</p> <p>SO 6997 FILTRE A HUILE OIL FILTER OELFILTER</p>  <p>H : 36 mm Ø : 60 mm ø : 17 mm</p>	<p>TRIUMPH</p> <p>SN 20759 FILTRE A GASOIL FUEL FILTER KRAFTSTOFF-FILTER</p>  <p>H : 93 mm Ø : 51 / 50 mm ø : 8 / 8 mm</p>	<p>VOXAN</p> <p>SO 6986 FILTRE A HUILE OIL FILTER OELFILTER</p>  <p>H : 74 / 70 mm Ø : 56 mm ø : 25 mm</p>
<p>SO 6998 FILTRE A HUILE OIL FILTER OELFILTER</p>  <p>H : 34 mm Ø : 60 mm ø : 17 mm</p>	<p>TRIUMPH MOTO</p> <p>SA 7941 FILTRE A AIR AIR FILTER LUFTFILTER</p>  <p>H : 50 mm L : 234 mm I : 100 mm</p>	<p>YAMAHA MOTO</p> <p>BE 4051 FILTRE A CARBURANT FUEL FILTER TREIBSTOFF-FILTER</p>  <p>H : 101 / 60 mm Ø : 34 / 28 mm ø : 10 / 10 mm</p>
<p>SO 6999 FILTRE A HUILE OIL FILTER OELFILTER</p>  <p>H : 66 / 65 mm Ø : 71 / 68 mm ø : M20X1</p>	<p>SO 6076 FILTRE A HUILE OIL FILTER OELFILTER</p>  <p>H : 57 mm Ø : 76 mm ø : 20 / 20 mm</p>	<p>RT 2 FILTRE A CARBURANT FUEL FILTER TREIBSTOFF-FILTER</p>  <p>H : 100 / 45 mm Ø : 36 / 31 mm ø : 8 / 6 mm</p>
<p>T 9337 FILTRE A HUILE OIL FILTER OELFILTER</p>  <p>H : 76 / 75 mm Ø : 83 / 80 mm ø : 3/4"-16UNF</p>	<p>SO 6955 FILTRE A HUILE OIL FILTER OELFILTER</p>  <p>H : 66 / 64 mm Ø : 68 / 65 mm ø : M20X1,5</p>	<p>SA 2032 FILTRE A AIR AIR FILTER LUFTFILTER</p>  <p>H : 229 mm Ø : 100 / 90 mm ø : 62 mm</p>
<p>TGB</p> <p>SA 7972 FILTRE A AIR AIR FILTER LUFTFILTER</p>  <p>H : 171 / 128 mm Ø : 88 / 52 mm ø : 50 / 0 mm</p>	<p>URAL</p> <p>SO 6939 FILTRE A HUILE OIL FILTER OELFILTER</p>  <p>H : 123 mm Ø : 52 mm ø : 15 mm</p>	<p>SA 2100 FILTRE A AIR AIR FILTER LUFTFILTER</p>  <p>H : 35 / 27 mm L : 317 mm I : 172 mm</p>
<p>TM RACING</p> <p>SO 6978 FILTRE A HUILE OIL FILTER OELFILTER</p>  <p>H : 45 / 40 mm Ø : 38 mm ø : 14 mm</p>	<p>VESRAH</p> <p>SO 6955 FILTRE A HUILE OIL FILTER OELFILTER</p>  <p>H : 66 / 64 mm Ø : 68 / 65 mm ø : M20X1,5</p>	<p>SA 7553 FILTRE A AIR AIR FILTER LUFTFILTER</p>  <p>H : 59 mm Ø : 177 / 148 mm</p>

MOTONEIGES - QUADS | SNOWMOBILE - ATV | SCHNEEMOBIL - QUADS

YAMAHA MOTO	YAMAHA MOTO	YAMAHA MOTO
<p>SA 7554 FILTRE A AIR AIR FILTER LUFTFILTER</p> <p>H : 206 mm Ø : 116 / 84 mm</p> 	<p>SA 7816 FILTRE A AIR AIR FILTER LUFTFILTER</p> <p>H : 135 / 128 mm Ø : 117 / 109 mm ø : 47 mm</p> 	<p>SA 7876 FILTRE A AIR AIR FILTER LUFTFILTER</p> <p>H : 110 / 101 mm Ø : 154 / 122 mm ø : 96 / 64 mm</p> 
<p>SA 7793 FILTRE A AIR AIR FILTER LUFTFILTER</p> <p>H : 15 mm L : 212 mm I : 196 mm</p> 	<p>SA 7818 FILTRE A AIR AIR FILTER LUFTFILTER</p> <p>H : 83 / 73 mm Ø : 154 / 123 mm ø : 68 mm</p> 	<p>SA 7883 FILTRE A AIR AIR FILTER LUFTFILTER</p> <p>H : 48 / 41 mm Ø : 195 mm ø : 144 mm</p> 
<p>SA 7804 FILTRE A AIR AIR FILTER LUFTFILTER</p> <p>H : 170 / 157 mm Ø : 113 / 106 mm ø : 78 / 56 mm</p> 	<p>SA 7859 FILTRE A AIR AIR FILTER LUFTFILTER</p> <p>H : 100 mm Ø : 158 mm ø : 112 mm</p> 	<p>SA 7886 FILTRE A AIR AIR FILTER LUFTFILTER</p> <p>H : 34 mm L : 331 mm I : 115 mm</p> 
<p>SA 7809 FILTRE A AIR AIR FILTER LUFTFILTER</p> <p>H : 86 / 79 mm Ø : 177.5 / 156 mm ø : 164 / 142 mm</p> 	<p>SA 7860 FILTRE A AIR AIR FILTER LUFTFILTER</p> <p>H : 144 mm L : 120 mm I : 112 mm</p> 	<p>SA 7887 FILTRE A AIR AIR FILTER LUFTFILTER</p> <p>H : 38 mm L : 363 mm I : 173 mm</p> 
<p>SA 7810 FILTRE A AIR AIR FILTER LUFTFILTER</p> <p>H : 25 mm L : 266 / 207 mm I : 148 / 109 mm</p> 	<p>SA 7861 FILTRE A AIR AIR FILTER LUFTFILTER</p> <p>H : 130 / 111 mm Ø : 84 / 60 mm ø : 52 mm</p> 	<p>SA 7888 FILTRE A AIR AIR FILTER LUFTFILTER</p> <p>H : 30 mm L : 280 mm I : 126 mm</p> 
<p>SA 7814 FILTRE A AIR AIR FILTER LUFTFILTER</p> <p>H : 235 mm Ø : 160 / 105 mm ø : 118 / 65 mm</p> 	<p>SA 7875 FILTRE A AIR AIR FILTER LUFTFILTER</p> <p>H : 30 mm L : 317 mm I : 138 mm</p> 	<p>SA 7902 FILTRE A AIR AIR FILTER LUFTFILTER</p> <p>H : 102 mm Ø : 183 / 175 mm ø : 8 mm</p> 



MOTONEIGES - QUADS | SNOWMOBILE - ATV | SCHNEEMOBIL - QUADS

YAMAHA MOTO	YAMAHA MOTO	YAMAHA MOTO
<p>SA 7936 FILTRE A AIR AIR FILTER LUFTFILTER</p>  <p>H : 38 / 28 mm L : 161 mm I : 100 mm</p>	<p>SA 8962 FILTRE A AIR AIR FILTER LUFTFILTER</p>  <p>H : 187 / 179 mm Ø : 102 mm ø : 70 / 7 mm</p>	<p>SO 6936 FILTRE A HUILE OIL FILTER OELFILTER</p>  <p>H : 37 mm Ø : 49 mm</p>
<p>SA 7942 FILTRE A AIR AIR FILTER LUFTFILTER</p>  <p>H : 208 mm Ø : 95 / 65 mm</p>	<p>SA 8966 FILTRE A AIR AIR FILTER LUFTFILTER</p>  <p>H : 220 mm Ø : 91 mm ø : 67 mm</p>	<p>SO 6955 FILTRE A HUILE OIL FILTER OELFILTER</p>  <p>H : 66 / 64 mm Ø : 68 / 65 mm ø : M20X1,5</p>
<p>SA 7957 FILTRE A AIR AIR FILTER LUFTFILTER</p>  <p>H : 34 mm L : 157 mm I : 93.5 mm</p>	<p>SA 8967 FILTRE A AIR AIR FILTER LUFTFILTER</p> 	<p>SO 6969 FILTRE A HUILE OIL FILTER OELFILTER</p>  <p>H : 52 / 50 mm Ø : 72 / 68 mm ø : M20X1,5</p>
<p>SA 7958 FILTRE A AIR AIR FILTER LUFTFILTER</p>  <p>H : 122 / 118 mm Ø : 121 / 110 mm ø : 65 / 65 mm</p>	<p>SA 8987 FILTRE A AIR AIR FILTER LUFTFILTER</p>  <p>H : 155 / 150 mm Ø : 89 mm ø : 58 mm</p>	<p>SO 6978 FILTRE A HUILE OIL FILTER OELFILTER</p>  <p>H : 45 / 40 mm Ø : 38 mm ø : 14 mm</p>
<p>SA 7959 FILTRE A AIR AIR FILTER LUFTFILTER</p>  <p>H : 104 / 98 mm Ø : 128 / 92 mm ø : 88 / 55 mm</p>	<p>SA 8999 FILTRE A AIR AIR FILTER LUFTFILTER</p>  <p>H : 55 mm L : 149 mm I : 121 / 116 mm</p>	<p>SO 6988 FILTRE A HUILE OIL FILTER OELFILTER</p>  <p>H : 55 mm Ø : 44 mm ø : 13.5 mm</p>
<p>SA 7977 FILTRE A AIR AIR FILTER LUFTFILTER</p>  <p>H : 93 / 83 mm Ø : 102 mm ø : 52 / 52 mm</p>	<p>SO 6076 FILTRE A HUILE OIL FILTER OELFILTER</p>  <p>H : 57 mm Ø : 76 mm ø : 20 / 20 mm</p>	<p>SO 6989 FILTRE A HUILE OIL FILTER OELFILTER</p>  <p>H : 48 / 44 mm Ø : 38 mm ø : 12.5 mm</p>

YAMAHA MOTO**SO 6990**FILTRE A HUILE
OIL FILTER
OELFILTER

H : 61 / 51 mm

Ø : 55 mm

ø : 18 mm

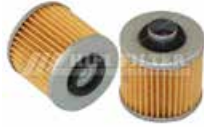
**SO 6991**FILTRE A HUILE
OIL FILTER
OELFILTER

H : 38 mm

Ø : 101 mm

ø : 20 / 20 mm

**SO 6992**FILTRE A HUILE
OIL FILTER
OELFILTER

H : 38 / 37 mm

Ø : 76 mm

ø : 20 / 20 mm

**T 59**FILTRE A HUILE
OIL FILTER
OELFILTER

H : 73 / 72 mm

Ø : 68 / 65 mm

ø : M20X1,5

**T 8307**FILTRE A HUILE
OIL FILTER
OELFILTER

H : 88 / 86 mm

Ø : 71.5 / 68 mm

ø : M20X1,5





**ENNEIGEMENT ARTIFICIEL
ARTIFICIAL SNOW
KUNSTSCHNEE**



CANONS À NEIGE SNOW CANNONS SCHNEEKANONEN

CANONS À NEIGE (APPLICATIONS)

SNOW CANNONS (APPLICATIONS)
SCHNEEKANONEN (ANWENDUNGEN)

102

FILTRES POUR CANONS À NEIGE

FILTERS FOR SNOW CANNONS
FILTER FÜR SCHNEEKANONEN

104

CANONS À NEIGE | SNOW CANNONS | SCHNEEKANONEN

BORER

830 A

Type mach. CANON A NEIGE
 Mot.make ATLAS COPCO
 Air/Luft : SA 10015

DEMAG

CANON A NEIGE

Type mach. CANON A NEIGE
 Air/Luft : SA 19146

JOHNSON CONTROLS NEIGE

VOIR/SEE/SIEHE YORK

Type mach. .

LATEMAR

BABY

Type mach. CANON A NEIGE
 Mot.make MATTEI
 Mot.type 22
 Air1/Luft: SA 19149
 Separat. : OA 1067

BABY AT

Type mach. CANON A NEIGE
 Air/Luft : SA 19149
 Eau/Water: EZ 20270

M 20

Type mach. CANON A NEIGE
 Eau/Water: EZ 20270

M 90

Type mach. CANON A NEIGE
 Mot.make HYDROVANNE
 Mot.type 33
 Air1/Luft: SA 19131
 Separat. : OA 3415

LENKO

2000 FA

Type mach. CANON A NEIGE

2690

Type mach. CANON A NEIGE
 Eau/Water: EZ 50000

300

Type mach. CANON A NEIGE

880

Type mach. CANON A NEIGE
 Eau/Water: EZ 30021

950

Type mach. CANON A NEIGE
 Mot.make ATLAS COPCO
 Air/Luft : SA 10015

SMI

CANON A NEIGE

Type mach. CANON A NEIGE
 Air/Luft : SA 19197

STRATUS

Type mach. CANON A NEIGE
 Mot.make HYDROVANNE
 Mot.type 025
 Separat. : OA 1086

SNOW STAR

CANON A NEIGE

Type mach. CANON A NEIGE
 Air1/Luft: SA 19146
 Eau/Water: EZ 45000

PIC

Type mach. CANON A NEIGE
 Eau/Water: EZ 20000

STAR NEIGE

ARAMIS 500

Type mach. CANON A NEIGE
 Mot.make ATLAS COPCO
 Air/Luft : SA 10015
 Eau/Water: EZ 30021

D 2000

Type mach. CANON A NEIGE
 Mot.make ATLAS COPCO
 Air/Luft : SA 10015
 Eau/Water: EZ 30021

SUFAG

SUPER SILENT

Type mach. CANON A NEIGE
 Eau/Water: EZ 27100

TECHNO ALPIN

A 30

Type mach. CANON A NEIGE
 Mot.make KAESER
 Mot.type KC 1500
 Air/Luft : SA 17224 X2

BABY

Type mach. CANON A NEIGE
 Eau/Water: EZ 20070 COMPLET/HOUSING
 Eau/Water: EZ 16070 CARTE/INS

BABY AT

Type mach. CANON A NEIGE
 Eau/Water: EZ 20270

M 12

Type mach. CANON A NEIGE
 Air/Luft : SA 19382 X2
 Eau/Water: EZ 27070

TECHNO ALPIN

M 20

Type mach. CANON A NEIGE
 Eau/Water: EZ 27070

M 90

Type mach. CANON A NEIGE
 Eau/Water: EZ 20470

T 40

Type mach. CANON A NEIGE
 Air/Luft : SA 19382 X2
 Eau/Water: EZ 41070 COMPLET/HOUSING
 Eau/Water: EZ 37070 CART/EINS

T 60

Type mach. CANON A NEIGE
 Air/Luft : SA 19382 X2
 Eau/Water: EZ 41070 COMPLET/HOUSING
 Eau/Water: EZ 37070 CART/EINS

TF 10

Type mach. CANON A NEIGE
 Air/Luft : SA 19382 X2

V 3

Type mach. CANON A NEIGE
 Eau/Water: EZ 03009 X3

WIZZARD

CANON A NEIGE

Type mach. CANON A NEIGE
 Eau/Water: EZ 51000

YORK

NOUVEAU MODELE

Type mach. CANON A NEIGE
 Mot.make ATLAS COPCO
 Mot.type GA 200
 Air1/Luft: SA 10939 X2
 Hydraulic: SH 62250 X3
 Separat. : OT 2014

220

Type mach. CANON A NEIGE
 Mot.make TAMROCK
 Air1/Luft: SA 17094 300x300MM OU/ODER
 Air1/Luft: SA 14503 O:180MM
 Air2/Luft: SA 14504
 Hydraulic: SH 56191 +
 Hydraulic: SH 64033 X2 +
 Hydraulic: SH 56230
 Separat. : OD 4000 X6

220 D



















Type mach. CANON A NEIGE
 Mot.make MERCEDES
 Mot.type OM 441 LA
 Oil/Oel : SO 3327
 Gasoil : SN 70160 PREF/VORF PPE
 Gasoil : SN 1147 PRIM
 Gasoil : SN 066 X2 SECON
 Air1/Luft: SA 14010 X4
 Air2/Luft: SA 11793 X4
 Hydraulic: SH 56255 X3
 Separat. : OT 2049

YORK**440**



















Type mach.	CANON A NEIGE	
Air1/Luft:	NN 4414 GSGP	X2
Hydraulic:	SH 56361	
Hydraulic:	SH 70041	DRAIN
Separat. :	OA 1105	X3



CANONS À NEIGE | SNOW CANNONS | SCHNEEKANONEN











<p>BORER</p> <p>SA 10015 FILTRE A AIR AIR FILTER LUFTFILTER</p> <p>H : 48 / 43 mm Ø : 130 mm ø : 87 / 87 mm</p> 	<p>DEMAG</p> <p>SA 11551 FILTRE A AIR AIR FILTER LUFTFILTER</p> <p>H : 373 / 366 mm Ø : 250 / 198 mm ø : 104 / 8 mm</p> 	<p>DEMAG</p> <p>SA 14017 FILTRE A AIR AIR FILTER LUFTFILTER</p> <p>H : 296 / 285 mm Ø : 126 mm ø : 64 / 8.5 mm</p> 
<p>CICLONE</p> <p>EZ 45000 FILTRE POUR LIQUIDE LIQUID FILTER WASSERFILTER</p> <p>H : 453 mm Ø : 72 mm ø : 62 / 62 mm</p> <p>CICLONE / SNOW STAR (180µ) 32004003</p> 	<p>SA 11752 FILTRE A AIR AIR FILTER LUFTFILTER</p> <p>H : 475 / 461 mm Ø : 302 mm ø : 190 / 12 mm</p> 	<p>SA 14019 FILTRE A AIR AIR FILTER LUFTFILTER</p> <p>H : 382 / 370 mm Ø : 226 mm ø : 117 / 10 mm</p> 
<p>DEMAG</p> <p>SA 10300 K FILTRE A AIR AIR FILTER LUFTFILTER</p> <p>H : 269 / 259 mm Ø : 248 / 198 mm ø : 90 / 12 mm</p> 	<p>SA 11793 FILTRE A AIR AIR FILTER LUFTFILTER</p> <p>H : 475 mm Ø : 137 / 128 mm ø : 116 / 17 mm</p> 	<p>SA 14085 FILTRE A AIR AIR FILTER LUFTFILTER</p> <p>H : 336 / 322 mm Ø : 150 mm ø : 71 / 9 mm</p> 
<p>SA 10384 K FILTRE A AIR AIR FILTER LUFTFILTER</p> <p>H : 419 / 409 mm Ø : 258 / 201 mm ø : 135 / 17 mm</p> 	<p>SA 13990 FILTRE A AIR AIR FILTER LUFTFILTER</p> <p>H : 376 / 366 mm Ø : 198 mm ø : 103 / 8.5 mm</p> 	<p>SA 14472 FILTRE A AIR AIR FILTER LUFTFILTER</p> <p>H : 327 mm Ø : 79 / 70 mm ø : 63 / 16.5 mm</p> 
<p>SA 10920 FILTRE A AIR AIR FILTER LUFTFILTER</p> <p>H : 495 / 483 mm Ø : 308 / 242 mm ø : 131 / 10 mm</p> 	<p>SA 14008 FILTRE A AIR AIR FILTER LUFTFILTER</p> <p>H : 351 / 339 mm Ø : 164 mm ø : 86 / 8.5 mm</p> 	<p>SA 19146 FILTRE A AIR AIR FILTER LUFTFILTER</p> <p>H : 96 mm Ø : 230 mm ø : 185 / 185 mm</p> 
<p>SA 10939 FILTRE A AIR AIR FILTER LUFTFILTER</p> <p>H : 360 / 350 mm Ø : 350 mm ø : 240 / 14 mm</p> 	<p>SA 14010 FILTRE A AIR AIR FILTER LUFTFILTER</p> <p>H : 495 / 485 mm Ø : 242 mm ø : 132 / 10.5 mm</p> 	<p>LATEMAR</p> <p>EZ 27070 FILTRE POUR LIQUIDE LIQUID FILTER WASSERFILTER</p> <p>H : 270 mm Ø : 70 mm ø : 58 / 44 mm</p> 

CANONS À NEIGE | SNOW CANNONS | SCHNEEKANONEN















LATEMAR	LENKO	SNOW STAR
<p>OA 1067 SEPARATEUR AIR/HUILE AIR/OIL SEPARATOR LUFT/ÖL ABSCHIEDER</p> <p>H : 205 / 202 mm Ø : 70 mm ø : 38 / 38 mm</p> 	<p>SA 10015 FILTRE A AIR AIR FILTER LUFTFILTER</p> <p>H : 48 / 43 mm Ø : 130 mm ø : 87 / 87 mm</p> 	<p>EZ 50000 FILTRE POUR LIQUIDE LIQUID FILTER WASSERFILTER</p> <p>H : 500 / 424 mm Ø : 95 mm</p> 
<p>OA 3415 SEPARATEUR AIR/HUILE AIR/OIL SEPARATOR LUFT/ÖL ABSCHIEDER</p> <p>H : 203 / 199 mm Ø : 70 mm ø : 40 / 40 mm</p> 	<p>SMI EZ 30021 FILTRE POUR LIQUIDE LIQUID FILTER WASSERFILTER</p> <p>H : 377 / 301 mm Ø : 95 mm</p> <p>250µ</p> 	<p>SA 19146 FILTRE A AIR AIR FILTER LUFTFILTER</p> <p>H : 96 mm Ø : 230 mm ø : 185 / 185 mm</p> 
<p>SA 19131 FILTRE A AIR AIR FILTER LUFTFILTER</p> <p>H : 59 mm Ø : 203 mm ø : 146 / 146 mm</p> 	<p>OA 1086 SEPARATEUR AIR/HUILE AIR/OIL SEPARATOR LUFT/ÖL ABSCHIEDER</p> <p>H : 85.5 / 75 mm Ø : 70 mm ø : 27 mm</p> 	<p>STAR NEIGE EZ 30021 FILTRE POUR LIQUIDE LIQUID FILTER WASSERFILTER</p> <p>H : 377 / 301 mm Ø : 95 mm</p> <p>250µ</p> 
<p>SA 19149 FILTRE A AIR AIR FILTER LUFTFILTER</p> <p>H : 83 mm Ø : 196 mm ø : 160 / 160 mm</p> 	<p>SA 19197 FILTRE A AIR AIR FILTER LUFTFILTER</p> <p>H : 80 mm Ø : 260 mm ø : 220 / 220 mm</p> 	<p>SA 10015 FILTRE A AIR AIR FILTER LUFTFILTER</p> <p>H : 48 / 43 mm Ø : 130 mm ø : 87 / 87 mm</p> 
<p>LENKO EZ 30021 FILTRE POUR LIQUIDE LIQUID FILTER WASSERFILTER</p> <p>H : 377 / 301 mm Ø : 95 mm</p> <p>250µ</p> 	<p>SNOW STAR EZ 20000 FILTRE POUR LIQUIDE LIQUID FILTER WASSERFILTER</p> <p>H : 202 mm Ø : 58 mm ø : 53 mm</p> <p>200µ</p> 	<p>SUFAG EZ 27100 FILTRE POUR LIQUIDE LIQUID FILTER WASSERFILTER</p> <p>H : 269 mm Ø : 92 mm ø : 89 mm</p> 
<p>EZ 50000 FILTRE POUR LIQUIDE LIQUID FILTER WASSERFILTER</p> <p>H : 500 / 424 mm Ø : 95 mm</p> 	<p>EZ 45000 FILTRE POUR LIQUIDE LIQUID FILTER WASSERFILTER</p> <p>H : 453 mm Ø : 72 mm ø : 62 / 62 mm</p> <p>CICLONE / SNOW STAR (180µ) 32004003</p> 	<p>TAMROCK OA 1105 SEPARATEUR AIR/HUILE AIR/OIL SEPARATOR LUFT/ÖL ABSCHIEDER</p> <p>H : 1100 / 996 mm Ø : 153 mm ø : 90 mm</p> 



CANONS À NEIGE | SNOW CANNONS | SCHNEEKANONEN

TAMROCK	TECHNO ALPIN	TECHNO ALPIN
<p>OD 4000 SEPARATEUR AIR/HUILE AIR/OIL SEPARATOR LUFT/ÖL ABSCHIEDER</p> <p>H : 413 / 401 mm Ø : 100 mm ø : 54 / 16 mm</p> 	<p>EZ 16070 FILTRE POUR LIQUIDE LIQUID FILTER WASSERFILTER</p> <p>H : 162 mm Ø : 69 mm ø : 65 / 65 mm</p> <p>1000µ</p> 	<p>EZ 41070 FILTRE POUR LIQUIDE LIQUID FILTER WASSERFILTER</p> <p>H : 412.5 mm Ø : 71.5 mm ø : 69 / 67 mm</p> <p>1000µ</p> 
<p>SA 10939 FILTRE A AIR AIR FILTER LUFTFILTER</p> <p>H : 360 / 350 mm Ø : 350 mm ø : 240 / 14 mm</p> 	<p>EZ 20070 FILTRE POUR LIQUIDE LIQUID FILTER WASSERFILTER</p> <p>H : 200 mm Ø : 71.5 mm ø : 69 / 67 mm</p> <p>1000µ</p> 	<p>NN 4414 GSGP FILTRE A AIR AIR FILTER LUFTFILTER</p> <p>H : 97 mm L : 492 mm l : 492 mm</p> 
<p>SA 11551 FILTRE A AIR AIR FILTER LUFTFILTER</p> <p>H : 373 / 366 mm Ø : 250 / 198 mm ø : 104 / 8 mm</p> 	<p>EZ 20270 FILTRE POUR LIQUIDE LIQUID FILTER WASSERFILTER</p> <p>H : 201 mm Ø : 70 mm ø : 58 / 44 mm</p> 	<p>SA 17224 FILTRE A AIR AIR FILTER LUFTFILTER</p> <p>H : 80 mm Ø : 98 mm ø : 68 / 68 mm</p> 
<p>SA 13990 FILTRE A AIR AIR FILTER LUFTFILTER</p> <p>H : 376 / 366 mm Ø : 198 mm ø : 103 / 8.5 mm</p> 	<p>EZ 20470 FILTRE POUR LIQUIDE LIQUID FILTER WASSERFILTER</p> <p>H : 203 mm Ø : 70 mm ø : 58 mm</p> 	<p>SA 19382 FILTRE A AIR AIR FILTER LUFTFILTER</p> <p>H : 70 mm Ø : 60 mm ø : 35.8 / 35.8 mm</p> 
<p>SA 14008 FILTRE A AIR AIR FILTER LUFTFILTER</p> <p>H : 351 / 339 mm Ø : 164 mm ø : 86 / 8.5 mm</p> 	<p>EZ 27070 FILTRE POUR LIQUIDE LIQUID FILTER WASSERFILTER</p> <p>H : 270 mm Ø : 70 mm ø : 58 / 44 mm</p> 	<p>SH 56230 FILTRE HYDRAULIQUE HYDRAULIC FILTER HYDRAULIKFILTER</p> <p>H : 260 mm Ø : 106 mm ø : 72 / 9 mm</p> 
<p>SA 17094 FILTRE A AIR AIR FILTER LUFTFILTER</p> <p>H : 265 / 255 mm Ø : 301 / 301 mm ø : 127 mm</p> 	<p>EZ 37070 FILTRE POUR LIQUIDE LIQUID FILTER WASSERFILTER</p> <p>H : 374 mm Ø : 69 mm ø : 64 / 64 mm</p> <p>1000µ</p> 	<p>SH 56361 FILTRE HYDRAULIQUE HYDRAULIC FILTER HYDRAULIKFILTER</p> <p>H : 480 mm Ø : 126 mm ø : 92 / 9 mm</p> 

CANONS À NEIGE | SNOW CANNONS | SCHNEEKANONEN

<p>YORK</p> <p>NN 4414 GSGP</p> <p>FILTRE A AIR AIR FILTER LUFTFILTER</p> <p>H : 97 mm L : 492 mm l : 492 mm</p> 	<p>YORK</p> <p>SA 11793</p> <p>FILTRE A AIR AIR FILTER LUFTFILTER</p> <p>H : 475 mm Ø : 137 / 128 mm ø : 116 / 17 mm</p> 	<p>YORK</p> <p>SH 56361</p> <p>FILTRE HYDRAULIQUE HYDRAULIC FILTER HYDRAULIKFILTER</p> <p>H : 480 mm Ø : 126 mm ø : 92 / 9 mm</p> 
<p>OA 1105</p> <p>SEPARATEUR AIR/HUILE AIR/OIL SEPARATOR LUFT/ÖL ABSCHIEDER</p> <p>H : 1100 / 996 mm Ø : 153 mm ø : 90 mm</p> 	<p>SA 14010</p> <p>FILTRE A AIR AIR FILTER LUFTFILTER</p> <p>H : 495 / 485 mm Ø : 242 mm ø : 132 / 10.5 mm</p> 	<p>SH 64033</p> <p>FILTRE HYDRAULIQUE HYDRAULIC FILTER HYDRAULIKFILTER</p> <p>H : 238 / 236 mm Ø : 137 / 137 mm ø : 1"1/2-16UNF</p> 
<p>OD 4000</p> <p>SEPARATEUR AIR/HUILE AIR/OIL SEPARATOR LUFT/ÖL ABSCHIEDER</p> <p>H : 413 / 401 mm Ø : 100 mm ø : 54 / 16 mm</p> 	<p>SA 17094</p> <p>FILTRE A AIR AIR FILTER LUFTFILTER</p> <p>H : 265 / 255 mm Ø : 301 / 301 mm ø : 127 mm</p> 	<p>SN 066</p> <p>FILTRE A GASOIL FUEL FILTER KRAFTSTOFF-FILTER</p> <p>H : 144 / 130 mm Ø : 83 mm ø : 11 / 11 mm</p> 
<p>OT 2014</p> <p>SEPARATEUR AIR/HUILE AIR/OIL SEPARATOR LUFT/ÖL ABSCHIEDER</p> <p>H : 550 mm Ø : 596 / 555 / 348 mm ø : 263 mm</p> 	<p>SH 56191</p> <p>FILTRE HYDRAULIQUE HYDRAULIC FILTER HYDRAULIKFILTER</p> <p>H : 210 / 208 mm Ø : 94 / 94 mm ø : 1"-12UNF</p> 	<p>SN 1147</p> <p>FILTRE A GASOIL FUEL FILTER KRAFTSTOFF-FILTER</p> <p>H : 145 / 131 mm Ø : 85 mm ø : 13.5 / 13.5 mm</p> 
<p>OT 2049</p> <p>SEPARATEUR AIR/HUILE AIR/OIL SEPARATOR LUFT/ÖL ABSCHIEDER</p> <p>H : 559 / 547 mm Ø : 400 / 354 / 263 mm ø : 164 mm</p> 	<p>SH 56230</p> <p>FILTRE HYDRAULIQUE HYDRAULIC FILTER HYDRAULIKFILTER</p> <p>H : 260 mm Ø : 106 mm ø : 72 / 9 mm</p> 	<p>SN 70160</p> <p>FILTRE A GASOIL FUEL FILTER KRAFTSTOFF-FILTER</p> <p>H : 41 / 38 mm Ø : 50 / 47 mm ø : 40.5 / 27.5 mm</p> 
<p>SA 10939</p> <p>FILTRE A AIR AIR FILTER LUFTFILTER</p> <p>H : 360 / 350 mm Ø : 350 mm ø : 240 / 14 mm</p> 	<p>SH 56255</p> <p>FILTRE HYDRAULIQUE HYDRAULIC FILTER HYDRAULIKFILTER</p> <p>H : 209 / 207 mm Ø : 98 / 95.5 mm ø : 1"-12UNF</p> 	<p>SO 3327</p> <p>FILTRE A HUILE OIL FILTER OELFILTER</p> <p>H : 270 / 243 mm Ø : 120 mm ø : 56 / 14 mm</p> 





AIR COMPRIMÉ COMPRESSED AIR DRUCKLUFT

COMPRESSEURS ET KIT DE MAINTENANCE

COMPRESSORS AND MAINTENANCE KIT
KOMPRESSOREN UND WARTUNGSKIT

110

KITS DE RECHANGE POUR SÉPARATEURS DE CONDENSATS

SPARE KIT FOR SEPARATOR OF CONDENSATE
ERSATZKIT FÜR KONDENSATABSCHEIDER

112

SÉPARATEURS AIR / HUILE

AIR / OIL SEPARATOR
LUFT / ÖL - ABSCHIEDER

123



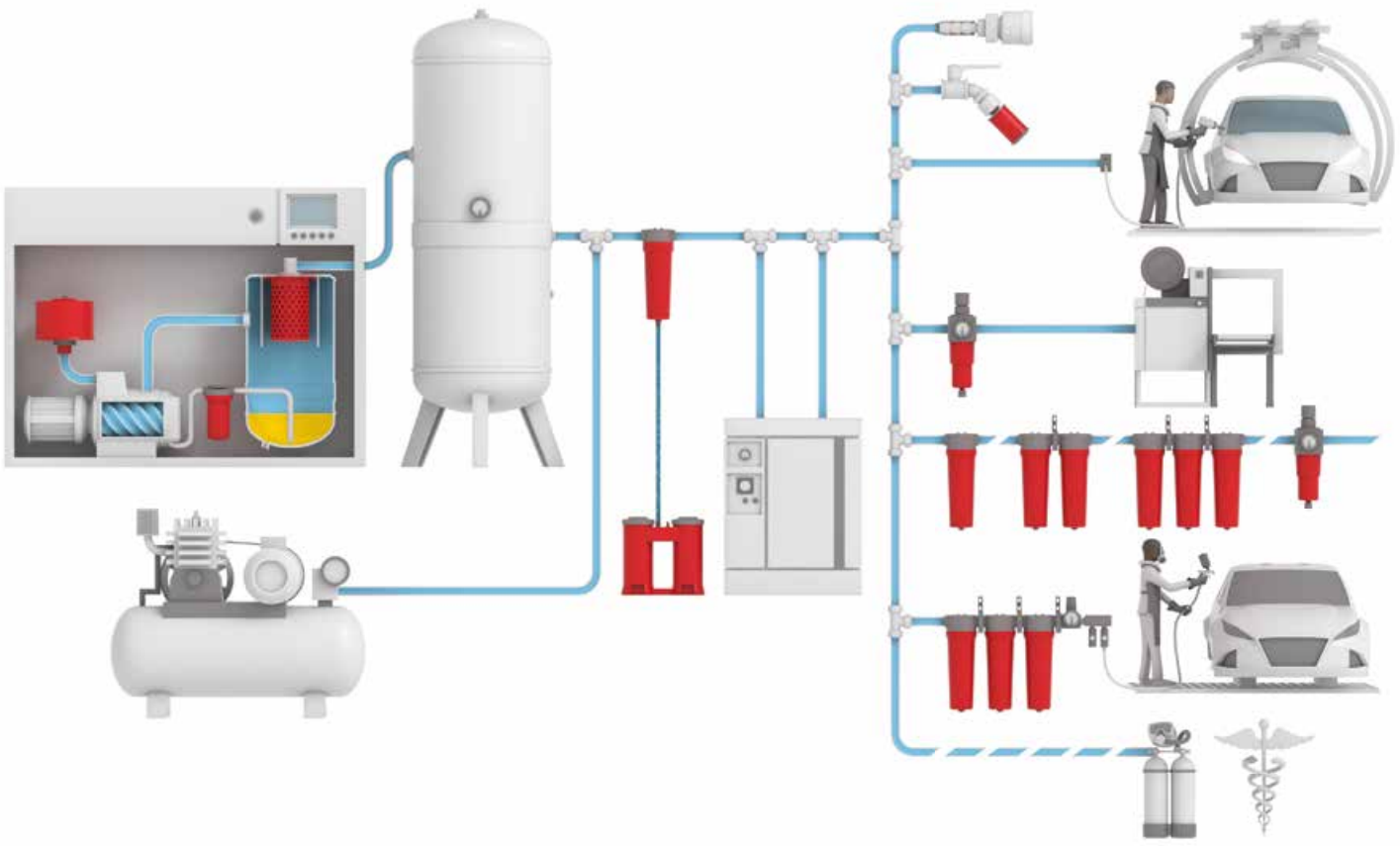

i

KITS DE RECHANGE POUR SÉPARATEURS DE CONDENSATS SPARE KIT FOR SEPARATOR OF CONDENSATE ERSATZKIT FÜR KONDENSATABSCHIEDER

POURQUOI TRAITER LES CONDENSATS ?

Le condensat produit par les compresseurs lubrifiés par huile contient, selon les saisons, une quantité d'huile comprise entre 200 et 1000 mg/l. C'est-à-dire que le condensat se compose environ de 99% d'eau et de 1% d'huile seulement. La loi considère cependant ce condensat comme une eau usée contenant de l'huile. En tant que telle, il est interdit de l'évacuer dans les égouts. La loi sur le régime des eaux fixe les exigences appliquées en matière de propreté des eaux résiduelles. Elle prescrit que la teneur en substances nuisibles contenues dans les eaux usées soit maintenue au seuil aussi bas que les "règles techniques généralement reconnues" le permettent. Ces règles ont été définies par les autorités dans le cadre des règlements généraux administratifs.

Cela signifie que le condensat doit être éliminé ou traité de manière appropriée.

Le procédé peut être assuré d'une manière fiable et économique par certains systèmes de traitement de condensat. Ils permettent de traiter efficacement les condensats et de réduire leur teneur en matières polluantes aux valeurs maximales admissibles (pour les hydrocarbures par exemple 10 à 20 mg/l maxi).

TRAITEMENT SUR SITE DES CONDENSATS ISSUS DE L'AIR COMPRIMÉ

En raison du pourcentage d'eau élevé présent dans le condensat huileux, il est toujours préférable de le traiter sur site. L'eau ainsi traitée peut être évacuée dans les égouts. L'huile séparée est éliminée en même temps que l'huile usagée.

Les séparateurs de liquides légers et les séparateurs centrifuge simples ne permettent pas d'obtenir les valeurs limites prescrites par le législateur.

Les séparateurs huile-eau sont des appareils parfaitement adaptés pour effectuer un traitement conforme à la législation.

NORME

L'application de la norme ISO 14000 sur l'environnement implique la mise en place d'un traitement des condensats.

AVANTAGES

S'équiper d'un système permet à l'utilisateur de compresseurs de traiter lui-même les condensats retenus dans l'air comprimé et de réduire la quantité de condensat à éliminer à un strict minimum. Comparé à un traitement de la quantité totale de condensat par une société spécialisée, un système permet de réduire les coûts d'élimination de près de 90 %. Le coût d'investissement dans l'achat d'un appareil de traitement est très vite amorti.

WHY TREAT CONDENSATE ?

The condensate produced by compressors that are lubricated with oil contains between 200 and 1000 mg/l of oil depending on the season. This means that condensate is composed of about 99% water and only 1% oil. The law considers this condensate as used water that contains oil. As such, it cannot be evacuated through the sewers. The law on water sets the requirements that have to be applied in terms of the cleanliness of residual water. It requires that the harmful substances contained in used water be maintained as low as allowed by the "technical regulations that are generally recognized". These regulations were defined by the authorities within the framework of the general administrative regulations.

This means that condensate must be eliminated or treated in an appropriate manner.

This process can be ensured by certain condensate treatment systems in a reliable and economical manner. They make it possible to efficiently treat condensate and to reduce their level of pollution to the maximal values allowed (e.g., 10 to 20 mg/l max for hydrocarbons).

TREATING THE CONDENSATE FORMED BY COMPRESSED AIR ON SITE

In view of the elevated percentage of water present within oily condensate, it is always preferable to treat it on site. Treated water can then be evacuated through the sewers. The oil that was separated from the water can be eliminated with the used oil.

Light liquid and simple centrifugal separators do not make it possible to reach the limited values prescribed by the legislator.

The oil-water separators are devices that are perfectly suitable to treat condensate as required by law.

REGULATION

The application of the ISO 14000 regulation concerning the environment implies the implementation of condensate treatments.

ADVANTAGES

Making use of a system allows a compressor user to treat the condensate contained within compressed air and to reduce the amount of condensate that must be eliminated to a strict minimum. When compared to a treatment for the total amount of condensate carried out by a specialized company, a system makes it possible to reduce the elimination costs by almost 90%. The cost of investing in a treatment device is quickly recovered.

VORTEILE DER KONDENSATAUFBEREITUNG

Kondensat aus ölgeschmierten Druckluftkompressoren enthält, je nach Jahreszeit, Ölanteile zwischen 200 und 1.000 mg/l. Dies bedeutet, dass das Kondensat zu etwa 99 % aus Wasser und nur zu 1 % aus Öl besteht. Trotzdem gilt dieses Kondensat laut Gesetz als ölhaltiges Abwasser. Als solches darf es nicht in die öffentliche Kanalisation gelangen. Die Anforderungen an die Sauberkeit des Abwassers sind im Wasserhaushaltsgesetz (WHG) geregelt. Es schreibt vor, dass die Schädlichkeit des Abwassers so gering zu halten ist, wie dies bei Einhaltung der jeweils in Betracht kommenden „Verfahren nach dem Stand der Technik“ möglich ist. Diese Verfahren werden von der Bundesregierung im Rahmen von allgemeinen Verwaltungsvorschriften festgelegt.

Dies bedeutet, dass das Kondensat fachgerecht entsorgt oder aufbereitet werden muss.

Dies lässt sich auf zuverlässige und wirtschaftliche Art und Weise durch Kondensataufbereitungssysteme erreichen. Mit ihnen kann Kondensat effektiv aufbereitet und die Schadstofffracht auf die anwendbaren Grenzwerte (für Kohlenwasserstoffe beispielsweise höchstens 10-20 mg/l) reduziert werden.

AUFBEREITUNG VON DRUCKLUFTKONDENSAT VOR ORT

Aufgrund des hohen Wasseranteils lohnt es sich immer, das ölhaltige Kondensat vor Ort aufzubereiten. So aufbereitetes Wasser kann der Kanalisation zugeführt werden. Das abgeschiedene Öl ist mit dem Altöl zu entsorgen.

Mit einfachen Leichtflüssigkeits- und Schwerkraftabscheidern lassen sich die vom Gesetzgeber vorgeschriebenen Grenzwerte nicht erreichen. Für die gesetzeskonforme Aufbereitung eignen sich jedoch Öl-Wasser-Trenner perfekt.

NORM

Gemäß der Umweltmanagementnorm ISO 14000 ist ein Kondensataufbereitungssystem vorzusehen.

VORTEILE

Die Ausstattung mit einem solchen System ermöglicht es den Benutzern von Kompressoren, das in der Druckluft enthaltene Kondensat selbst aufzufangen und die Kondensatmenge auf ein absolutes Minimum zu reduzieren. Im Vergleich zur Aufbereitung der gesamten Kondensatmenge durch ein spezialisiertes Unternehmen können die Entsorgungskosten so um fast 90 % gesenkt werden. Die Investitionskosten für den Kauf eines Kondensataufbereitungssystems sind also sehr schnell abgeschrieben.

FR
EN
DE

KITS DE RECHANGE POUR SÉPARATEURS DE CONDENSATS SPARE KIT FOR SEPARATOR OF CONDENSATE ERSATZKIT FÜR KONDENSATABSCHIEDER



1	Chambre de détente Expansion chamber Druckentlastungskammer
2	Réservoir de pré-séparation Pre-separation tank Trennbehälter
3	Collecteur amovible Removable collector Herausnehmbarer Schmutzauffangbehälter
4	Réservoir collecteur d'huile Oil collector tank Ölauffangbehälter
5	Préfiltre Pre-filter Vorfilter
6	Cartouche de filtre Filter cartridge Filterpatrone
7	Sortie d'eau Water outlet Ablaufstutzen
8	Évacuation pour test de turbidité Evacuation for the turbidity test Probeentnahme für die Trübungsmessung





FR Le condensat huileux est conduit sous pression dans la chambre de détente (1) où il se décomprime puis pénètre dans le réservoir de séparation (2) suivant sans turbulence. La plus grande partie des impuretés entraînées avec le condensat est retenue dans un collecteur amovible (3). L'huile séparée dans le réservoir par la force centrifuge se dépose à la surface pour être amenée dans le réservoir collecteur d'huile (4) équipé d'une sécurité de trop-plein. Le condensat préalablement épuré passe alors par les filtres. Il traverse le préfiltre (5) qui retient les gouttelettes d'huile. Les dernières particules d'huile sont éliminées efficacement dans la cartouche du filtre principal (6). Le condensat ainsi traité quitte l'appareillage par la sortie d'eau (7).

EN The oily condensate is conducted under pressure within the expansion chamber (1) where it decompresses before entering the following separation tank (2) without turbulence. Most of the impurities contained in the condensate are retained in a removable collector (3). The oil that was separated into the tank through centrifugal force is settling on the surface to be driven into the oil collector tank (4), which is equipped with an over-full safety device. The condensate that was previously purified then moves through the filters. It goes through the pre-filter (5), which retains the oil droplets. The last oil particles are efficiently eliminated within the main filter cartridge (6). The treated condensate is therefore released from the device through the water outlet (7).

DE Das unter Hochdruck stehende ölhaltige Kondensat wird in die Druckentlastungskammer (1) geleitet. Dort baut sich der Überdruck ab und das Kondensat gelangt ohne Verwirbelungen in den Trennbehälter (2). Der größte Teil der vom Kondensat mitgeführten Verunreinigungen sammelt sich dabei im herausnehmbaren Schmutzauffangbehälter (3). Das aufgrund seiner geringeren Dichte leichtere Öl setzt sich an der Oberfläche ab und wird in den Ölauffangbehälter (4) geleitet, der mit einem Überlauf ausgestattet ist. Das so vorgereinigte Kondensat kann nun die Filter passieren. Im Vorfilter (5) werden die Öltröpfchen ausgefiltert. Die letzten Ölpartikel werden dann in der Hauptfilterpatrone (6) entfernt. Das aufbereitete Kondensat verlässt das Gerät über den Ablaufstutzen (7).





FR
 EN
 DE

KITS DE RECHANGE POUR SÉPARATEURS DE CONDENSATS
SPARE KIT FOR SEPARATOR OF CONDENSATE
ERSATZKIT FÜR KONDENSATABSCHIEDER

Désignation Description Beschreibung	N° OEM	N° Hifi	
ABAC			
Gamme WS WS range Serie WS	WS 13 KIT A	SIR 4130	
	WS 13 KIT B	SIR 4129	
	WS 13 KIT C/D	SIR 4114	
	WS 13 Absorbent bag only	SIR 4030	
	WS 13 Active carbon bag only	SIR 4031	
	WS 13 Active carbon and absorbent bags only	SIR 4014	
	WS 13 Active carbon bag (x1) and absorbent bags (x2) only	SIR 4048	
	WS 34 KIT A	SIR 4146	
	WS 34 KIT B	SIR 4149	
	WS 34 KIT C/D	SIR 4113	
	WS 34 Absorbent bag only	SIR 4046	
	WS 34 Active carbon bag only	SIR 4047	
	WS 34 Active carbon and absorbent bags only	SIR 4013	
	WS 34 Active carbon bag (x1) and absorbent bags (x2) only	SIR 4049	
	WS 52 KIT A	SIR 4150	
	WS 52 KIT B	SIR 4152	
	WS 52 KIT C/D	SIR 4115	
	WS 52 Absorbent bag only	SIR 4050	
	WS 52 Active carbon bag only	SIR 4051	
	WS 52 Active carbon and absorbent bags only	SIR 4015	
	WS 52 Active carbon bag (x1) and absorbent bags (x2) only	SIR 4052	
	WS 128 KIT A	SIR 4153	
	WS 128 KIT B	SIR 4155	
	WS 128 KIT C/D	SIR 4116	
	WS 128 Absorbent bag only	SIR 4053	
	WS 128 Active carbon bag only	SIR 4054	
	WS 128 Active carbon and absorbent bags only	SIR 4016	
	WS 128 Active carbon bag (x2) and absorbent bags (x4) only	SIR 4055	
	WS 218 KIT A	SIR 4156	
	WS 218 KIT B	SIR 4158	
	WS 218 KIT C/D	SIR 4117	
	WS 218 Absorbent bag only	SIR 4056	
	WS 218 Active carbon bag only	SIR 4057	
	WS 218 Active carbon and absorbent bags only	SIR 4017	
	WS 218 Active carbon bag (x2) and absorbent bags (x4) only	SIR 4058	
		Kit element WS 13/34/52	SA 190460
		Kit element WS 13/34/52	SA 190461
		Kit element WS 128/218	SA 190464
		Kit element WS 128/218	SFE 0002
		S 001	SIR 8000
	S 002	SIR 8002	
	S 003	SIR 8003	
	S 004	SIR 8004	
	S 005	SIR 8001	
	S 006	SIR 8005	

FR
 EN
 DE

KITS DE RECHANGE POUR SÉPARATEURS DE CONDENSATS
SPARE KIT FOR SEPARATOR OF CONDENSATE
ERSATZKIT FÜR KONDENSATABSCHIEDER

Désignation Description Beschreibung	N° OEM	N° Hifi
ATLAS COPCO		
	OSC 35 KIT A	SIR 4130
	OSC 35 KIT B	SIR 4129
	OSC 35 KIT C/D	SIR 4114
	OSC 35 Absorbent bag only	SIR 4030
	OSC 35 Active carbon bag only	SIR 4031
	OSC 35 Active carbon and absorbent bags only	SIR 4014
	OSC 35 Active carbon bag (x1) and absorbent bags (x2) only	SIR 4048
	OSC 95 KIT A	SIR 4146
	OSC 95 KIT B	SIR 4149
	OSC 95 KIT C/D	SIR 4113
	OSC 95 Absorbent bag only	SIR 4046
	OSC 95 Active carbon bag only	SIR 4047
	OSC 95 Active carbon and absorbent bags only	SIR 4013
	OSC 95 Active carbon bag (x1) and absorbent bags (x2) only	SIR 4049
	OSC 145 KIT A	SIR 4150
	OSC 145 KIT B	SIR 4152
	OSC 145 KIT C/D	SIR 4115
	OSC 145 Absorbent bag only	SIR 4050
	OSC 145 Active carbon bag only	SIR 4051
	OSC 145 Active carbon and absorbent bags only	SIR 4015
	OSC 145 Active carbon bag (x1) and absorbent bags (x2) only	SIR 4052
	OSC 355 KIT A	SIR 4153
	OSC 355 KIT B	SIR 4155
	OSC 355 KIT C/D	SIR 4116
	OSC 355 Absorbent bag only	SIR 4053
	OSC 355 Active carbon bag only	SIR 4054
	OSC 355 Active carbon and absorbent bags only	SIR 4016
	OSC 355 Active carbon bag (x2) and absorbent bags (x4) only	SIR 4055
	OSC 600 KIT A	SIR 4156
	OSC 600 KIT B	SIR 4158
	OSC 600 KIT C/D	SIR 4117
	OSC 600 Absorbent bag only	SIR 4056
	OSC 600 Active carbon bag only	SIR 4057
	OSC 600 Active carbon and absorbent bags only	SIR 4017
	OSC 600 Active carbon bag (x2) and absorbent bags (x4) only	SIR 4058
	 Kit element OSC 35/95/145	SA 190460
	 Kit element OSC 35/95/145	SA 190461
	 Kit element OSC 355/600	SA 190464
	 Kit element OSC 355/600	SFE 0002
	OSC 825	SIR 4018
	OSC 1200	SIR 4019
	OSC 2400	SIR 4020

 Gamme OSC
 OSC range
 Serie OSC





FR
 EN
 DE

KITS DE RECHANGE POUR SÉPARATEURS DE CONDENSATS
SPARE KIT FOR SEPARATOR OF CONDENSATE
ERSATZKIT FÜR KONDENSATABSCHIEDER





Désignation Description Beschreibung	N° OEM	N° Hifi
BEA		
Ancienne gamme OIL VIP Previous range OIL VIP Vorherige Serie OIL VIP	OIL VIP 100	SIR 8200
	OIL VIP 200	SIR 8201
	OIL VIP 400	SIR 8202
Gamme actuelle OIL VIP Present range OIL VIP Aktuelle Serie OIL VIP	OIL VIP 4	SIR 8203
	OIL VIP 5	SIR 8204
	OIL VIP 6	SIR 8205
BEKO		
Ancienne gamme ÖWAMAT Previous range ÖWAMAT Vorherige Serie ÖWAMAT	OWAMAT 3	SIR 4004
	OWAMAT 5	SIR 4001
	OWAMAT 20	SIR 4009
Gamme actuelle ÖWAMAT Present range ÖWAMAT Aktuelle Serie ÖWAMAT	OWAMAT 1	SIR 4002
	OWAMAT 2	SIR 4003
	OWAMAT 4	SIR 4005
	OWAMAT 5R	SIR 4011
	OWAMAT 6	SIR 4007
	OWAMAT 8	SIR 4008
CECCATO		
Gamme CECCATO EF (année 2000) CECCATO EF range (year 2000) Serie CECCATO (Jahr 2000)	EF 1000	SIR 3004
	EF 2000	SIR 3004
	EF 5000	SIR 3004
	EF 8000	SIR 3003
	EF 15000	SIR 3006
	EF 30000	SIR 3007
	EF 60000	SIR 3005
Gamme FOD OSC range Serie OSC	FOD 21 KIT A	SIR 4130
	FOD 21 KIT B	SIR 4129
	FOD 21 KIT C/D	SIR 4114
	FOD 21 Absorbent bag only	SIR 4030
	FOD 21 Active carbon bag only	SIR 4031
	FOD 21 Active carbon and absorbent bags only	SIR 4014
	FOD 21 Active carbon bag (x1) and absorbent bags (x2) only	SIR 4048
	FOD 57 KIT A	SIR 4146
	FOD 57 KIT B	SIR 4149
	FOD 57 KIT C/D	SIR 4113
	FOD 57 Absorbent bag only	SIR 4046
	FOD 57 Active carbon bag only	SIR 4047
	FOD 57 Active carbon and absorbent bags only	SIR 4013
	FOD 57 Active carbon bag (x1) and absorbent bags (x2) only	SIR 4049
	FOD 87 KIT A	SIR 4150
	FOD 87 KIT B	SIR 4152
	FOD 87 KIT C/D	SIR 4115
	FOD 87 Absorbent bag only	SIR 4050
	FOD 87 Active carbon bag only	SIR 4051
	FOD 87 Active carbon and absorbent bags only	SIR 4015
	FOD 87 Active carbon bag (x1) and absorbent bags (x2) only	SIR 4052
	FOD 213 KIT A	SIR 4153
	FOD 213 KIT B	SIR 4155
	FOD 213 KIT C/D	SIR 4116
	FOD 213 Absorbent bag only	SIR 4053
	FOD 213 Active carbon bag only	SIR 4054
	FOD 213 Active carbon and absorbent bags only	SIR 4016
	FOD 213 Active carbon bags (x2) and absorbent bags (x4) only	SIR 4055

FR
 EN
 DE

KITS DE RECHANGE POUR SÉPARATEURS DE CONDENSATS
SPARE KIT FOR SEPARATOR OF CONDENSATE
ERSATZKIT FÜR KONDENSATABSCHIEDER

Désignation Description Beschreibung	N° OEM	N° Hifi
Gamme FOD OSC range Serie OSC	FOD 360 KIT A	SIR 4156
	FOD 360 KIT B	SIR 4158
	FOD 360 KIT C/D	SIR 4117
	FOD 360 Absorbent bag only	SIR 4056
	FOD 360 Active carbon bag only	SIR 4057
	FOD 360 Active carbon and absorbent bags only	SIR 4017
	FOD 360 Active carbon bag (x2) and absorbent bags (x4) only	SIR 4058
	 Kit element FOD 21/57/87	SA 190460
	 Kit element FOD 21/57/87	SA 190461
	 Kit element FOD 213/360	SA 190464
	 Kit element FOD 213/360	SFE 0002
	FOD 495	SIR 4018
	FOD 720	SIR 4019
	FOD 1440	SIR 4020
	DOMNICK HUNTER	
Gamme H2OIL-X H2OIL-X range Serie H2OIL-X	KME 1010 / 2010	SIR 3000
	KME 1015 / 2015	SIR 3001
	KME 1030 / 2030	SIR 3002
Gamme actuelle (année 2000) Present range (year 2000) Aktuelle Serie (Jahr 2000)	2100 - ESMK 1	SIR 3004
	2150 - ESMK 1	SIR 3004
	2200 - ESMK 1	SIR 3004
	2300 - ESMK 2	SIR 3003
	2400 - ESMK 2	SIR 3006
	2500 - ESMK 3	SIR 3007
2600 - ESMK 3	SIR 3005	

FR
EN
DE
KITS DE RECHANGE POUR SÉPARATEURS DE CONDENSATS
SPARE KIT FOR SEPARATOR OF CONDENSATE
ERSATZKIT FÜR KONDENSATABSCHIEDER

Désignation Description Beschreibung	N° OEM	N° Hifi
FRIULAIR		
	OSC 35 KIT A	SIR 4130
	OSC 35 KIT B	SIR 4129
	OSC 35 KIT C/D	SIR 4114
	OSC 35 Absorbent bag only	SIR 4030
	OSC 35 Active carbon bag only	SIR 4031
	OSC 35 Active carbon and absorbent bags only	SIR 4014
	OSC 35 Active carbon bag (x1) and absorbent bags (x2) only	SIR 4048
	OSC 95 KIT A	SIR 4146
	OSC 95 KIT B	SIR 4149
	OSC 95 KIT C/D	SIR 4113
	OSC 95 Absorbent bag only	SIR 4046
	OSC 95 Active carbon bag only	SIR 4047
	OSC 95 Active carbon and absorbent bags only	SIR 4013
	OSC 95 Active carbon bag (x1) and absorbent bags (x2) only	SIR 4049
	OSC 145 KIT A	SIR 4150
	OSC 145 KIT B	SIR 4152
	OSC 145 KIT C/D	SIR 4115
	OSC 145 Absorbent bag only	SIR 4050
	OSC 145 Active carbon bag only	SIR 4051
	OSC 145 Active carbon and absorbent bags only	SIR 4015
	OSC 145 Active carbon bag (x1) and absorbent bags (x2) only	SIR 4052
	OSC 355 KIT A	SIR 4153
	OSC 355 KIT B	SIR 4155
	OSC 355 KIT C/D	SIR 4116
	OSC 355 Absorbent bag only	SIR 4053
	OSC 355 Active carbon bag only	SIR 4054
	OSC 355 Active carbon and absorbent bags only	SIR 4016
	OSC 355 Active carbon bags (x2) and absorbent bags (x4) only	SIR 4055
	OSC 600 KIT A	SIR 4156
	OSC 600 KIT B	SIR 4158
	OSC 600 KIT C/D	SIR 4117
	OSC 600 Absorbent bag only	SIR 4056
	OSC 600 Active carbon bag only	SIR 4057
	OSC 600 Active carbon and absorbent bags only	SIR 4017
	OSC 600 Active carbon bag (x2) and absorbent bags (x4) only	SIR 4058
	 Kit element OSC 35/95/145	SA 190460
	 Kit element OSC 35/95/145	SA 190461
	 Kit element OSC 355/600	SA 190464
	 Kit element OSC 355/600	SFE 0002
	OSC 825	SIR 4018
	OSC 1200	SIR 4019
	OSC 2400	SIR 4020

Gamme OSC
OSC range
Serie OSC





FR
 EN
 DE

KITS DE RECHANGE POUR SÉPARATEURS DE CONDENSATS
SPARE KIT FOR SEPARATOR OF CONDENSATE
ERSATZKIT FÜR KONDENSATABSCHIEDER

Désignation Description Beschreibung	N° OEM	N° Hifi
HIROSS		
Première gamme SOL (forme ronde) First range SOL (round shape) Erste Serie SOL (runde Form)	SOL 003	SIR 4004
	SOL 005	SIR 4001
Deuxième gamme SOL (forme carrée) Second range SOL (square shape) Zweite Serie SOL (quadratische Form)	SOL 1	SIR 2002
	SOL 3	SIR 2003
Gamme OWS (année 2000) OWS range (year 2000) Serie OWS (Jahr 2000)	OWS001	SIR 3004
	OWS060	SIR 3004
	OWS075	SIR 3004
	OWS125	SIR 3003
	OWS185	SIR 3006
	OWS355	SIR 3007
	OWS485	SIR 3005
HITEMA		
Gamme HD HD range Serie HD	MINI	SIR 2007
	HD 1	SIR 2007
	HD 2	SIR 2002
	HD 5	SIR 2002
	HD 8	SIR 2002
	HD 15	SIR 2002
	HD 30	SIR 2003
	HD 60	SIR 2006
JORC		
Gammes ENVIRO - PURO ENVIRO - PURO ranges Serie ENVIRO - PURO	ENVIRO CARBON	SIR 4304
	ENVIRO H2O	SIR 4305
	PURO MINI CARBON	SIR 4308
	PURO MINI H2O	SIR 4309
	PURO CARBON	SIR 4302
	PURO H2O	SIR 4303
	PURO GRAND CARBON	SIR 4300
	PURO GRAND H2O	SIR 4306
	PURO GRAND + XTENDER CARBON	SIR 4307
	PURO GRAND + XTENDER H2O	SIR 4306
	PURO ELITE 10	SIR 4310
PURO ELITE 20	SIR 4313	
PURO ELITE 30	SIR 4311	
KAESER		
Première gamme WO First range WO Erste Serie WO	WAT 2	SIR 2002
	WAT 3	SIR 2003
Deuxième gamme KWO Second range KWO Zweite Serie KWO	KWO 1/2	SIR 2002
	KWO 3/4	SIR 2003
Troisième gamme KWO Third range KWO Dritte Serie KWO	KWO 1	SIR 2002
	KWO 2	SIR 2002
	KWO 3	SIR 2003
	KWO 4	SIR 2006
KLÜBER LIBRICATION		
Gamme CONDEPHASE CONDEPHASE range Serie CONDEPHASE	CONDEPHASE 15 - CPF 003	SIR 5005
	CONDEPHASE 30 - CPF 005	SIR 5006
	CONDEPHASE 80 - CPF 016	SIR 5007
	CONDEPHASE 160 - CPF 030	SIR 5008

FR
 EN
 DE

KITS DE RECHANGE POUR SÉPARATEURS DE CONDENSATS
SPARE KIT FOR SEPARATOR OF CONDENSATE
ERSATZKIT FÜR KONDENSATABSCHIEDER

Désignation Description Beschreibung	N° OEM	N° Hifi
MAUGUIERE		
	FOD 21 KIT A	SIR 4130
	FOD 21 KIT B	SIR 4129
	FOD 21 KIT C/D	SIR 4114
	FOD 21 Absorbent bag only	SIR 4030
	FOD 21 Active carbon bag only	SIR 4031
	FOD 21 Active carbon and absorbent bags only	SIR 4014
	FOD 21 Active carbon bag (x1) and absorbent bags (x2) only	SIR 4048
	FOD 57 KIT A	SIR 4146
	FOD 57 KIT B	SIR 4149
	FOD 57 KIT C/D	SIR 4113
	FOD 57 Absorbent bag only	SIR 4046
	FOD 57 Active carbon bag only	SIR 4047
	FOD 57 Active carbon and absorbent bags only	SIR 4013
	FOD 57 Active carbon bag (x1) and absorbent bags (x2) only	SIR 4049
	FOD 87 KIT A	SIR 4150
	FOD 87 KIT B	SIR 4152
	FOD 87 KIT C/D	SIR 4115
	FOD 87 Absorbent bag only	SIR 4050
	FOD 87 Active carbon bag only	SIR 4051
	FOD 87 Active carbon and absorbent bags only	SIR 4015
	FOD 87 Active carbon bag (x1) and absorbent bags (x2) only	SIR 4052
	FOD 213 KIT A	SIR 4153
	FOD 213 KIT B	SIR 4155
	FOD 213 KIT C/D	SIR 4116
	FOD 213 Absorbent bag only	SIR 4053
	FOD 213 Active carbon bag only	SIR 4054
	FOD 213 Active carbon and absorbent bags only	SIR 4016
	FOD 213 Active carbon bags (x2) and absorbent bags (x4) only	SIR 4055
	FOD 360 KIT A	SIR 4156
	FOD 360 KIT B	SIR 4158
	FOD 360 KIT C/D	SIR 4117
	FOD 360 Absorbent bag only	SIR 4056
	FOD 360 Active carbon bag only	SIR 4057
	FOD 360 Active carbon and absorbent bags only	SIR 4017
	FOD 360 Active carbon bags (x2) and absorbent bags (x4) only	SIR 4058
	 Kit element FOD 21/57/87	SA 190460
	 Kit element FOD 21/57/87	SA 190461
	 Kit element FOD 213/360	SA 190464
	 Kit element FOD 213/360	SFE 0002
	FOD 495	SIR 4018
	FOD 720	SIR 4019
	FOD 1440	SIR 4020

 Gamme FOD
 OSC range
 Serie OSC

FR
 EN
 DE

KITS DE RECHANGE POUR SÉPARATEURS DE CONDENSATS
SPARE KIT FOR SEPARATOR OF CONDENSATE
ERSATZKIT FÜR KONDENSATABSCHIEDER

Désignation Description Beschreibung	N° OEM	N° Hifi
MTA		
Ancienne gamme SAO Previous range SAO Vorherige Serie SAO	SAO 1	SIR 3000
	SAO 2	SIR 3001
	SAO 3	SIR 3002
Gamme actuelle SAO Present range SAO Aktuelle Serie SAO	SAO 16	SIR 4002
	SAO 33	SIR 4003
	SAO 100	SIR 4005
	SAO 190	SIR 4011
	SAO 340	SIR 4007
	SAO 1020	SIR 4008
O.M.I		
-	KA 001	SIR 8000
	KA 002	SIR 8002
	KA 003	SIR 8003
	KA 004	SIR 8004
	KA 005	SIR 8001
	KA 006	SIR 8005
	KTRON 25	SIR 8007
	KTRON 50	SIR 8008
	KTRON 90	SIR 8006
	KTRON 180	SIR 8009
	KTRON 300	SIR 8011
	KTRON 600	SIR 8010
SEPURA		
-	SEP 120 ST	SIR 2014
	SEP 360 ST	SIR 2015
	SEP 900 ST	SIR 2016
	SEP 1250 ST	SIR 2022
	SEP 2500 ST	SIR 2022 (x2)
ULTRAFILTER		
Ancienne gamme ULTRASEP Previous range ULTRASEP Vorherige Serie ULTRASEP	UFS 3	SIR 4004
	UFS 5	SIR 4001
Ancienne gamme ULTRASEP-PLUS Previous range ULTRASEP-PLUS Vorherige Serie ULTRASEP-PLUS	UFS P + 7.5	SIR 1000
	UFS P + 15	SIR 1001
	UFS P + 30	SIR 1002
	UFS P + 60	SIR 1003
	UFS P + 120	SIR 1004
Gamme actuelle ULTRASEP-SUPERPLUS Present range ULTRASEP-SUPERPLUS Aktuelle Serie ULTRASEP-SUPERPLUS	UFS P + 240	SIR 1005
	UFS SP 5	SIR 1014
	UFS SP 7.5 / 10	SIR 1006
	UFS SP 15	SIR 1007
	UFS SP 30	SIR 1008
	UFS SP 60	SIR 1009
	UFS SP 120	SIR 1016
	UFS SP 240	SIR 1011

FR
 EN
 DE

KITS DE RECHANGE POUR SÉPARATEURS DE CONDENSATS
SPARE KIT FOR SEPARATOR OF CONDENSATE
ERSATZKIT FÜR KONDENSATABSCHEIDER

Désignation Description Beschreibung	N° OEM	N° Hifi
WORTHINGTON		
Première gamme ÖWAMAT First range ÖWAMAT Erste Serie ÖWAMAT	OWAMAT 3	SIR 4004
	OWAMAT 5	SIR 4001
Deuxième gamme OIL-VIP Second range OIL-VIP Zweite Serie OIL-VIP	OIL VIP 100	SIR 8000
	OIL VIP 200	SIR 8201
WORTMANN		
Ancienne gamme Previous range Vorherige Serie	WT 5	SIR 2009
	WT 10	SIR 2010
	WT 20	SIR 2011
	WT 30	SIR 2005
	WO I	SIR 2002
	WO II	SIR 2002
	WO III	SIR 2003
Gamme actuelle DRUKOMAT Present range DRUKOMAT Aktuelle Serie DRUKOMAT	DRUKOMAT MINI	SIR 2007
	DRUKOMAT 1	SIR 2007
	DRUKOMAT 2	SIR 2002
	DRUKOMAT 4 / 5	SIR 2002
	DRUKOMAT 8	SIR 2002
	DRUKOMAT 15	SIR 2002
	DRUKOMAT 30	SIR 2003
	DRUKOMAT 61	SIR 2006
Gamme actuelle DRUKOSEP Present range DRUKOSEP Aktuelle Serie DRUKOSEP	DRUKOSEP 1	SIR 2013
	DRUKOSEP 2	SIR 2021
	DRUKOSEP 3	SIR 2018
	DRUKOSEP 6	SIR 2019
	DRUKOSEP 8	SIR 2012
	DRUKOSEP 10	SIR 2020
ZANDER		
Première gamme ECOSEP WO First range ECOSEP WO Erste Serie ECOSEP WO	WAT 2	SIR 2002
	WAT 3	SIR 2003
Deuxième gamme WT Second range WT Zweite Serie WT	WT 1	SIR 2002
	WT 2	SIR 2003
Troisième gamme WT Third range WT Dritte Serie WT	WT 5	SIR 2009
	WT 10	SIR 2010
	WT 20	SIR 2011
	WT 30	SIR 2005
Quatrième gamme ECOSEP S Fourth range ECOSEP S Vierte Serie ECOSEP S	S1	SIR 2007
	S2	SIR 2002
	S4	SIR 2002
	S5	SIR 2002
	S8	SIR 2002
	S15	SIR 2002
	S30	SIR 2003
	S60	SIR 2006
Cinquième gamme ECOSEP SL Fifth range ECOSEP SL Fünfte Serie ECOSEP SL	SL 1	SIR 3004
	SL 2	SIR 3004
	SL 4	SIR 3004
	SL 5	SIR 3004
	SL 8	SIR 3003
	SL 15	SIR 3006
	SL 30	SIR 3007
	SL 60	SIR 3005

FR
EN
DE

SÉPARATEURS AIR / HUILE
AIR / OIL SEPARATOR
LUFT / ÖL - ABSCHIEDER

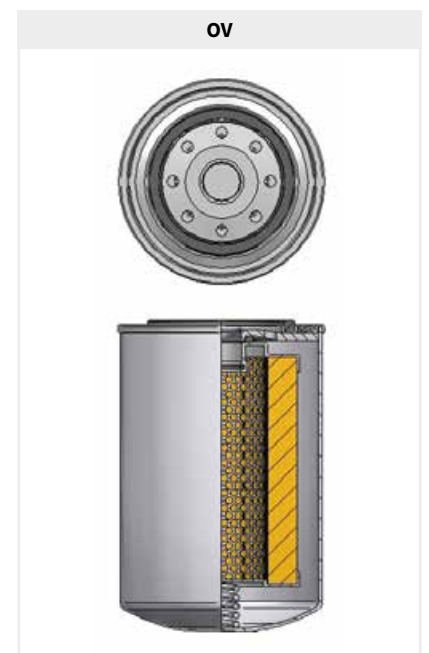
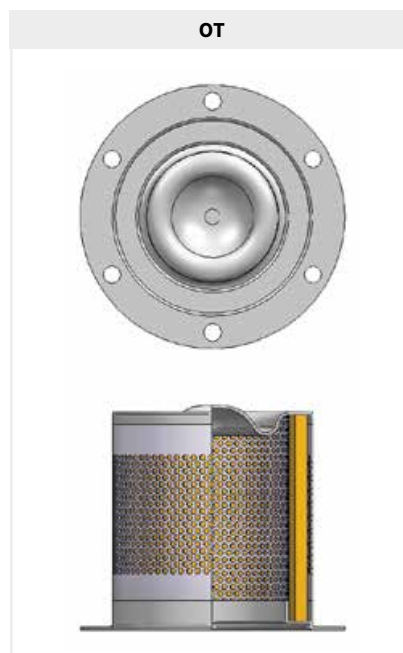
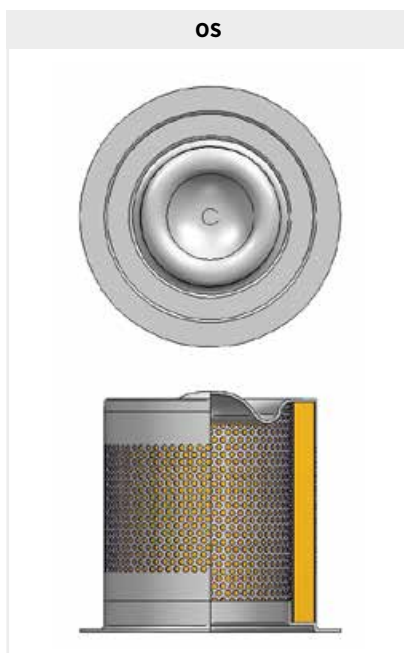
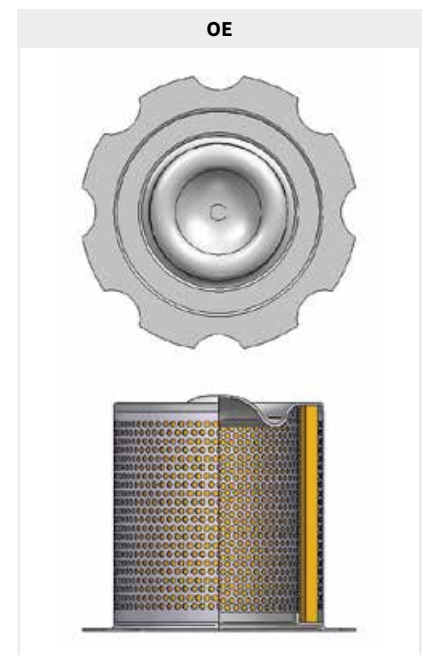

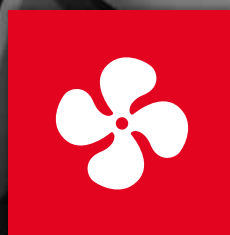

AÉRAULIQUE HVAC KLIMA UND BELÜFTUNG

NATTES FILTRANTES POLYESTER - SYNTHÉTIQUE

FILTER MATS POLYESTER - SYNTHETIC
FILTERMATTEN SYNTHETISCH - POLYESTER

126

FILTRES MOUSSE PPI

PPI FILTRATION FOAMS
PPI SCHAUMSTOFFFILTER

127

GAMME : AÉRAULIQUE

RANGE : HVAC RANGE
SORTIMENT : KLIMA UND BELÜFTUNG

128

FR
EN
DE
NATTES FILTRANTES POLYESTER - SYNTHÉTIQUE
FILTER MATS POLYESTER - SYNTHETIC
FILTERMATTEN SYNTHETISCH - POLYESTER



Découpe sur mesure possible
Custom cuts on demand
möglichen Zuschneiden nach Maß

N° Hifi	Classe filtration Filtration class Filterklassen		Efficacité gravimétrique Gravimetry efficiency Gravimetrie Effizienz <i>Am</i>	Dimensions Abmessungen		Weight <i>gr/m²</i>
	<i>eCoarse %</i> <i>ISO 16890</i>	<i>EN 779 : 2012</i>		Long. x Larg. Lenght x Width Breite x Länge <i>m</i>	Épaisseur Thickness Dicke <i>mm</i>	
N 40M02000 SA	30	G2	79 %	40 x 2	7	100
N 20M02000 SB	40	G3	85 %	20 x 2	10	150
N 20M02000 SL¹	50		87 %	20 X 2	20 ± 2	200
N 20M02000 SD	60	G4	89 %	20 x 2	22 ± 2	200
N 20M02000 SN¹	70		90 %	20 x 2	22 ± 2	220
N 20M02000 SE	75		91 %	20 x 2	17 ± 2	250
N 20M02000 SV	80		93 %	20 x 2	35 ± 2	350
N 20M02000 SQ	93		94 %	20 x 2	50 ± 2	400

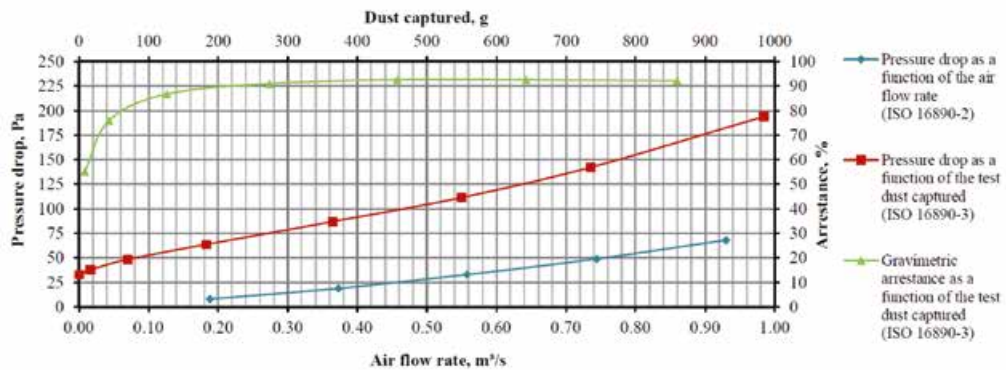
SL ▶

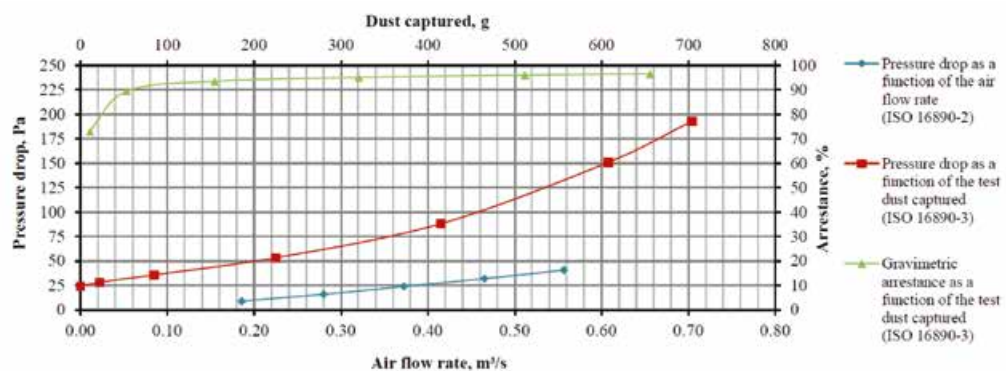

SN ▶



Autres modèles et découpes sur demande / Other models and cuts on request / Andere Modelle und Zuschnitt auf Anfrage.

1. *Média progressif bleu → blanc / Progressiv media blue → white / Progressive Medien blau → weiß*

FR
EN
DE
FILTRES MOUSSE PPI
PPI FILTRATION FOAMS
PPI SCHAUMSTOFFFILTER
POLYESTER

FR

Non traitées, ces mousses sont employées pour filtrer les liquides et les gaz. Sous une forme plus travaillée, on les utilise en tant que support.

Température de fonctionnement : -40 → +100°C

- Densité, pouvoir d'expansion et résistance aux déchirements élevés
- Bonne résistance à la plupart des solvants organiques
- Savon, huile, lubrifiant

EN

They are used untreated as liquid and gas filters, or in further refined form as filtration or carrier media.

Working temperature : -40 → +100°C

- Density, high expansion capacity and tear resistance
- Good resistance to most organic solvents
- Soap, oil, lubricant

DE

Sie werden unbehandelt als Flüssigkeits- und Gasfilter oder in einer edleren Form, als Filter oder Trägermedium eingesetzt.

Betriebstemperatur : -40 → +100°C

- Dichtheit, Ausdehnfähigkeit und hohe Rissfestigkeit
- Hohe Beständigkeit gegen einen Grossteil der organischen Lösungsmittel
- Seife, Öl, Schmiermittel

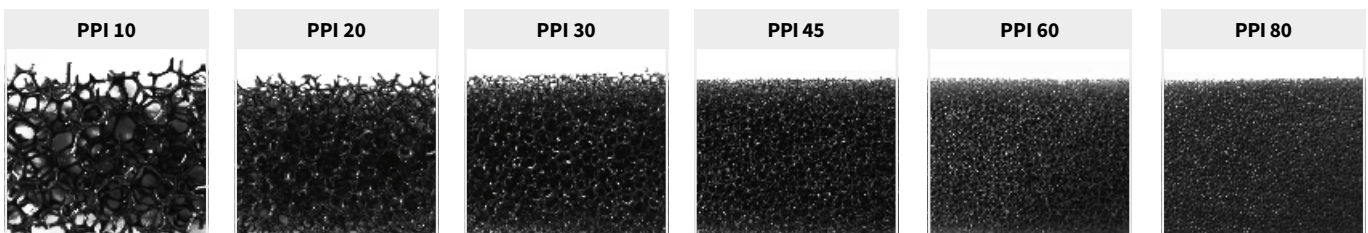





N° Hifi	Dimensions / Abmessungen <i>mm</i>		Grade Rank Reihe	PPI (pores / inch)	Résistance à la traction Tensile strength Zugfestigkeit <i>kPa</i>	Perméabilité Permeability Durchlässigkeit <i>L / (m² x s)</i>
	Épaisseur Thickness Dicke	L x l				
N 20001000 PA	5	2000 x 1000	10	8 → 13	100	7500
N 20001000 PB	10					
N 20001000 PC	20					
N 20001000 PE	5	2000 x 1000	20	16 → 23	120	5300
N 20001000 PF	10					
N 20001000 PG	20					
N 20001000 PI	5	2000 x 1000	30	27 → 34	150	3850
N 20001000 PJ	10					
N 20001000 PK	20					
N 20001000 PM	5	2000 x 1000	45	41 → 49	180	2850
N 20001000 PN	10					
N 20001000 PO	20					
N 20001000 PQ	5	2000 x 1000	60	57 → 70	200	1850
N 20001000 PR	10					
N 20001000 PS	20					
N 20001000 PU	5	2000 x 1000	80	75 → 90	250	1217
N 20001000 PV	10					
N 20001000 PW	20					

 *Autres dimensions et traitements spécifiques sur demande.*
Other dimensions and specific treatments on request.
Andere Dimensionen und spezifische Behandlung auf Anfrage.

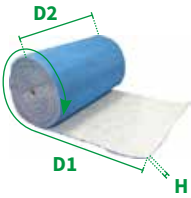
FR
 EN
 DE

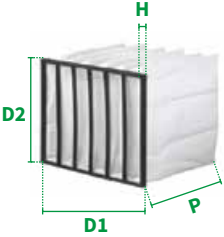
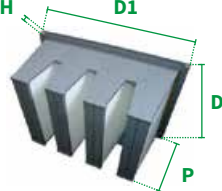
GAMME: AÉRAULIQUE
RANGE : HVAC RANGE
SORTIMENT : KLIMA UND BELÜFTUNG

Média Media Media	Panneau Panel Zellenfilter	Poche souple Soft pocket Taschenfilter	Poche rigide Rigid pocket Kompaktfilter	Cylindre Cylinder Zylinder
				
Efficacité Efficiency Leistung	Efficacité Efficiency Leistung	Efficacité Efficiency Leistung	Efficacité Efficiency Leistung	Efficacité Efficiency Leistung
Dimensions (Longueur, largeur, épaisseur...) Dimensions (Thickness, width, length...) Abmessungen (Dicke, Breite, Länge...)	Dimensions (Longueur, largeur, épaisseur...) Dimensions (Thickness, width, length...) Abmessungen (Dicke, Breite, Länge...)	Dimensions (Longueur, largeur, épaisseur...) Dimensions (Thickness, width, length...) Abmessungen (Dicke, Breite, Länge...)	Dimensions (Longueur, largeur, épaisseur...) Dimensions (Thickness, width, length...) Abmessungen (Dicke, Breite, Länge...)	Dimensions (Diamètre, hauteur...) Dimensions (Diameter, height...) Abmessungen (Durchmesser, Höhe ...)
Quantité Quantity Menge	Matière cadre Frame material Rahmenmaterial Quantité Quantity Menge	Matière cadre Frame material Rahmenmaterial Nombre de poches Pockets number Taschenzahl	Matière cadre Frame material Rahmenmaterial Nombre de poches Pockets number Taschenzahl	Quantité Quantity Menge
		Quantité Quantity Menge	Quantité Quantity Menge	

FR

Compatibles toutes marques.
 Divers médias de filtrations disponibles.
 Demandez notre offre détaillée en nous indiquant les dimensions, l'efficacité et les quantités souhaitées.

EN

Compatible to all brands.
 Various filter media available.
 Ask for further details indicating the dimensions, efficiency and quantities desired.

DE

Kompatibel an alle Marken.
 Verschiedene Filtermedien erhältlich
 Fragen Sie nach weiteren Details unter Angabe der gewünschten Abmessungen, Effizienz und Mengen.



A detailed black and white photograph of an engine compartment. The image shows various mechanical components including a large cooling fan on the left, a belt drive system with pulleys in the center, and an alternator on the right. The engine block and various hoses and wires are visible throughout the scene.

MOTEUR & ENVIRONNEMENT MATÉRIEL
ENGINE & EQUIPMENT ENVIRONMENT
MOTOR UND ZUSATZPRODUKTE

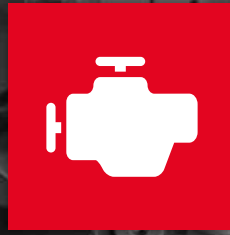

MOTEUR ENGINE MOTOR

AIR AIR LUFT	134
CARBURANT FUEL KRAFTSTOFF	136
HUILE OIL ÖL	138
AÉRATION MOTEUR ENGINE BREATHER MOTORENTLÜFTUNG	140
LIQUIDE DE REFROIDISSEMENT COOLANT KÜHLMITTEL	142
URÉE UREA HARNSTOFF	144



AIR



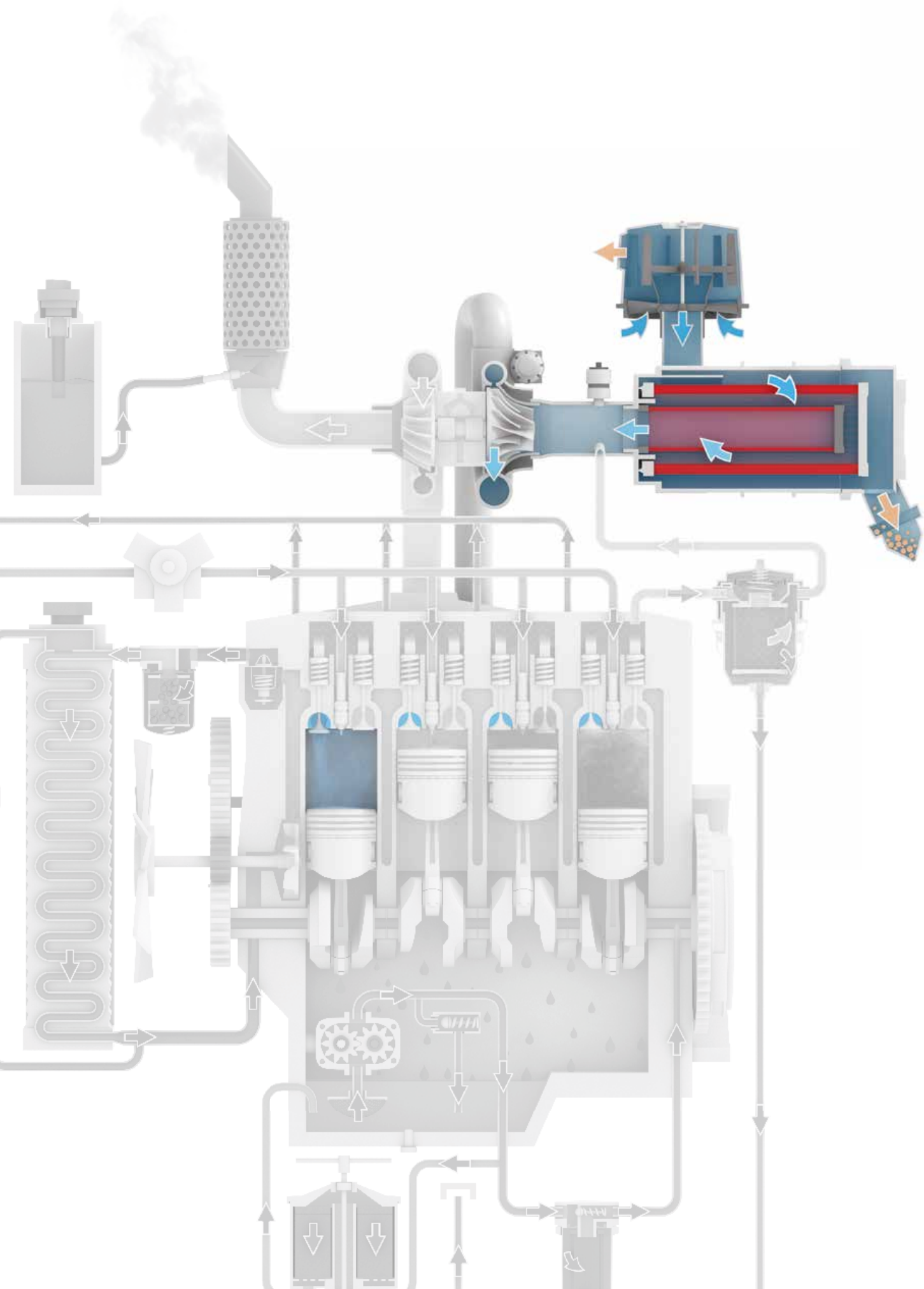



FUEL



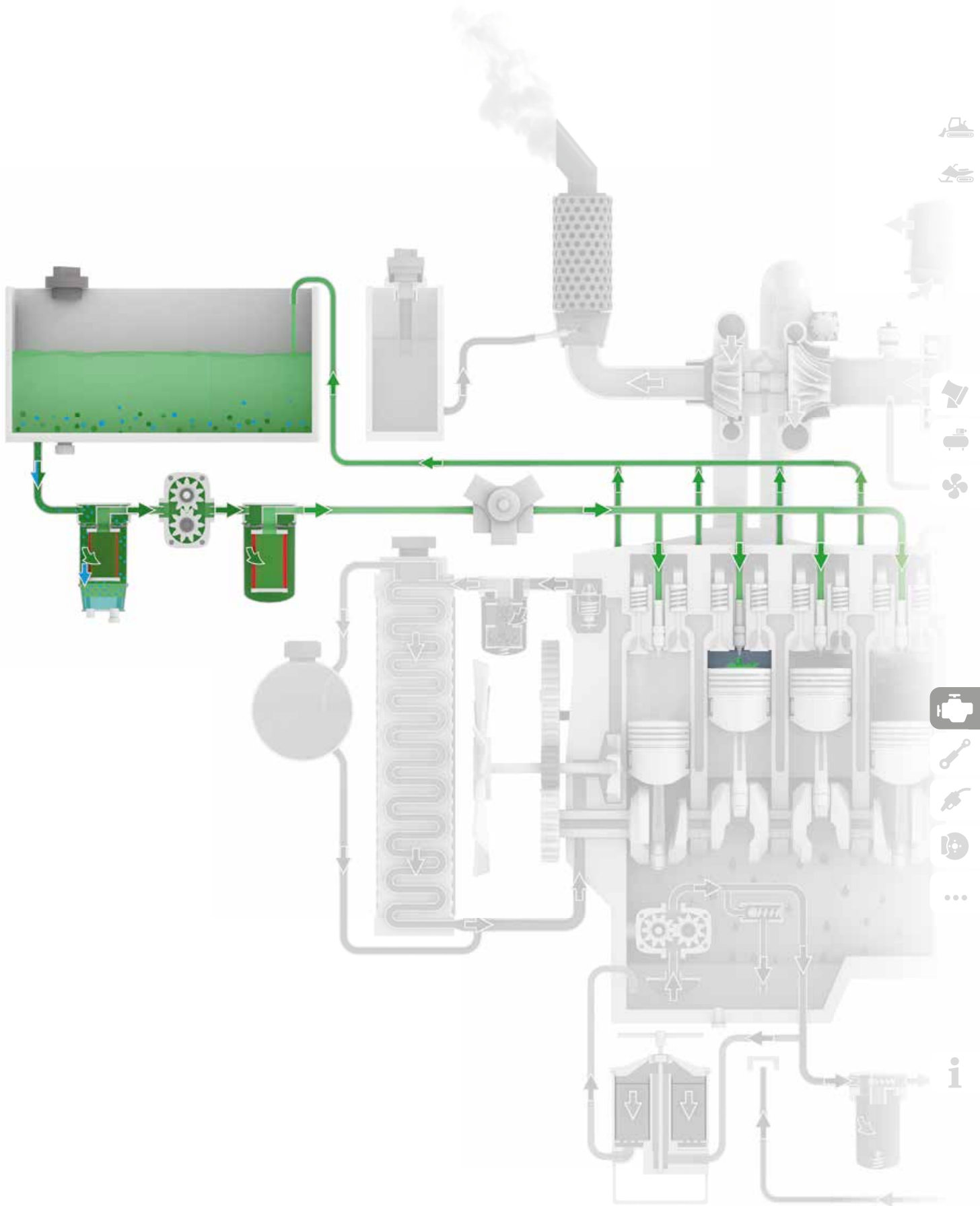



OIL



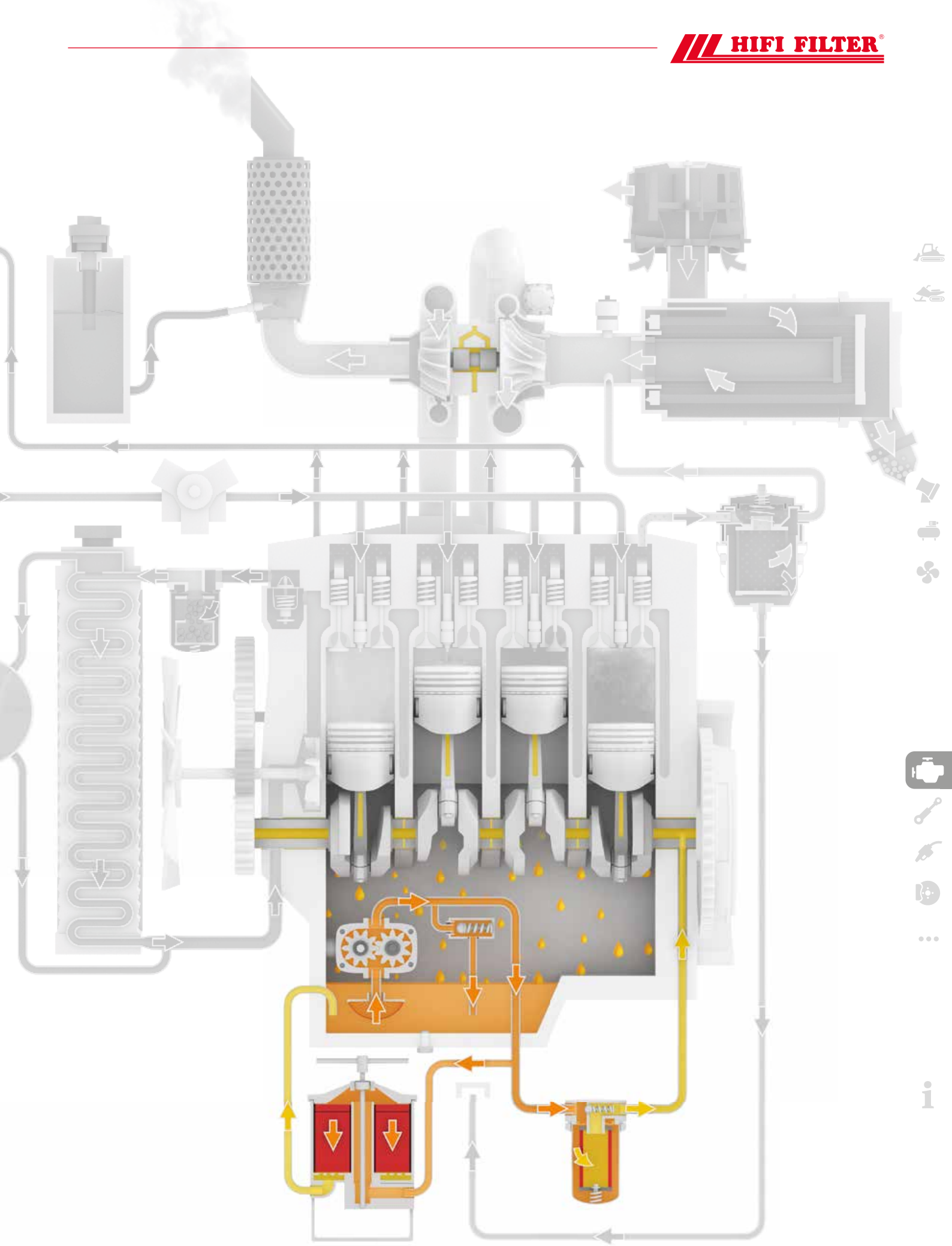



ENGINE BREATHER



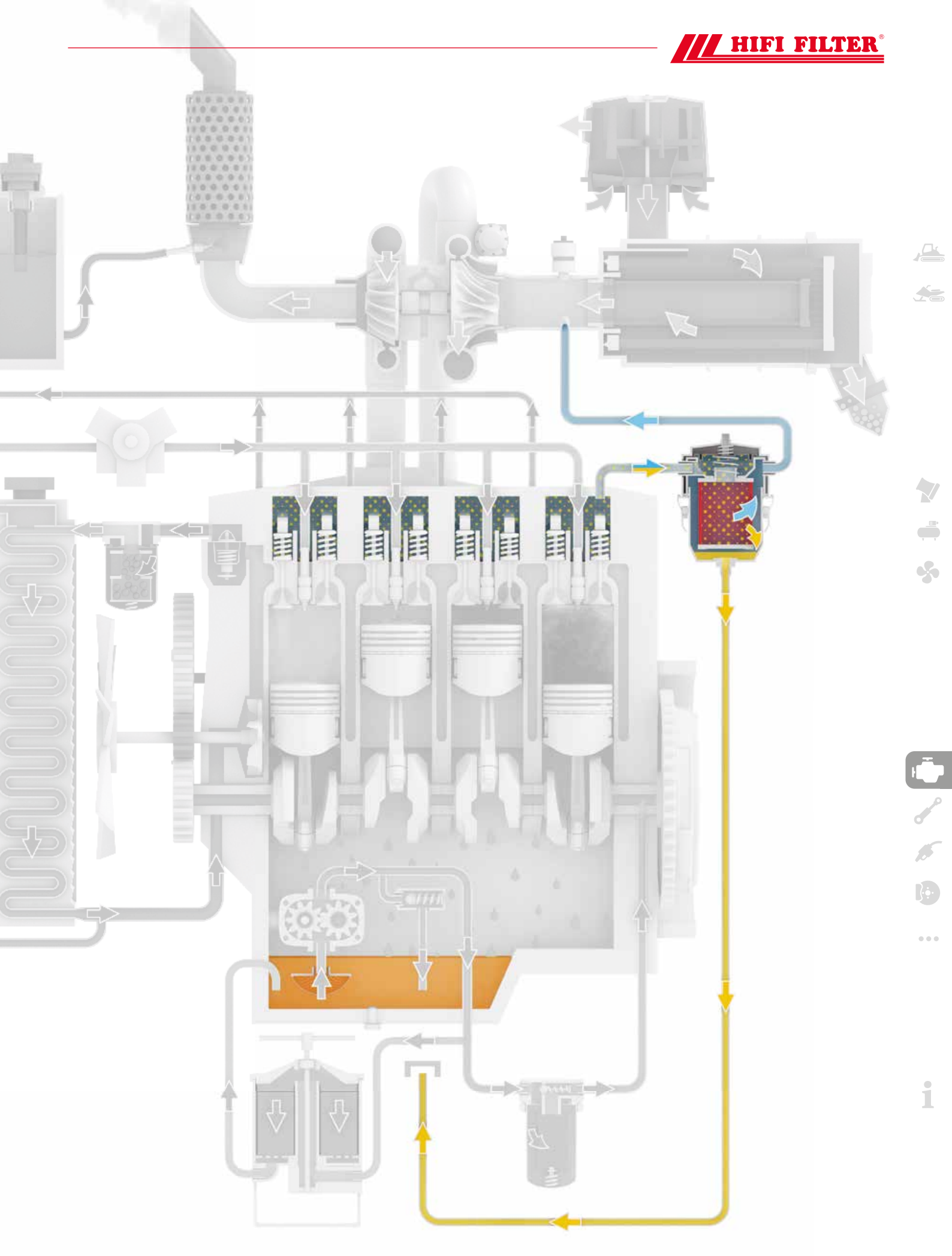



COOLANT



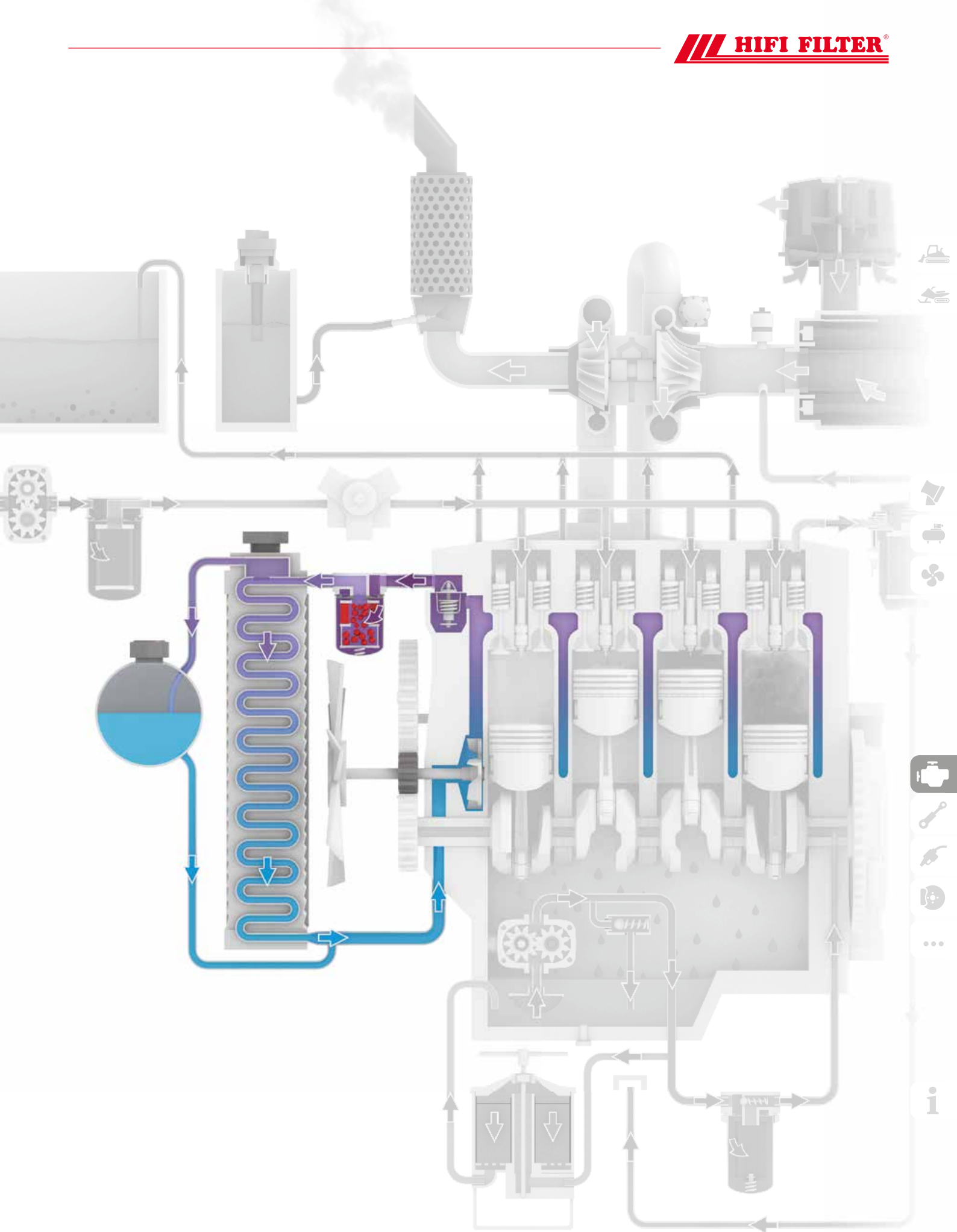



UREA



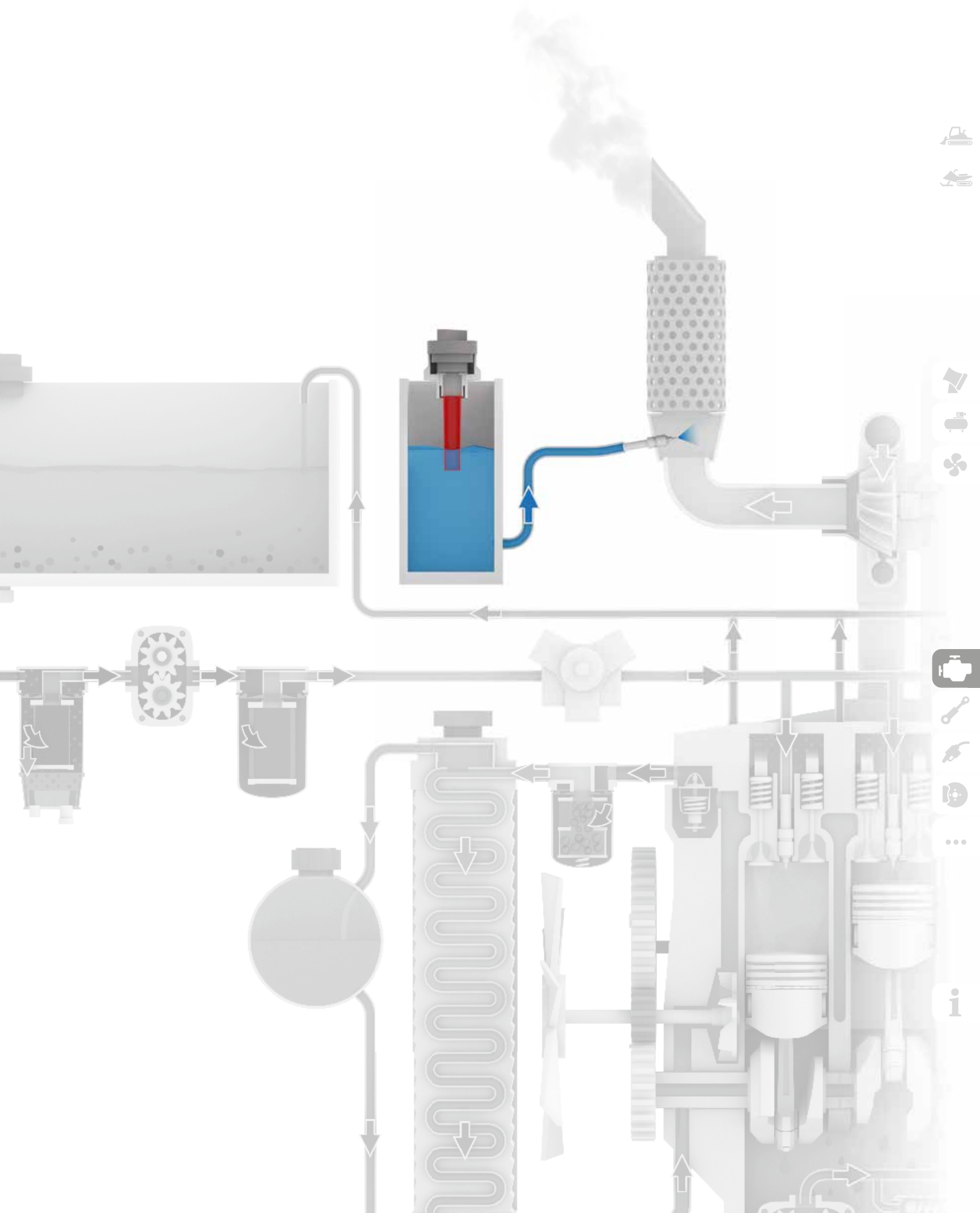



HYDRAULIQUE HYDRAULIC HYDRAULIK

HYDRAULIQUE

HYDRAULIC
HYDRAULIK

148

GROUPE MOBILE DE FILTRATION

MOBILE FILTRATION UNIT
MOBILE REINIGUNGSGERÄTE

150



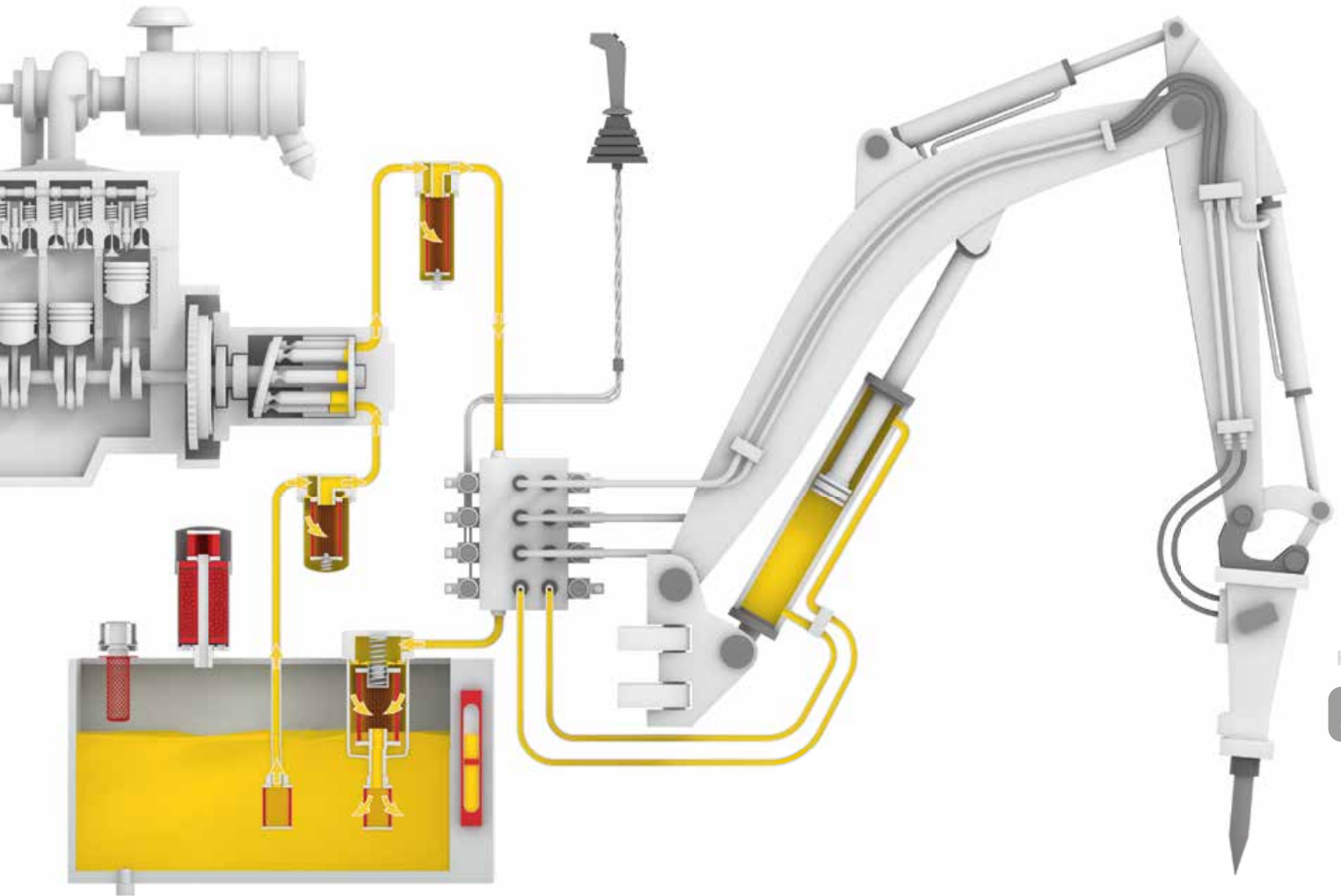



FR
 EN
 DE

GROUPE MOBILE DE TRANSFERT
MOBILE TRANSFER UNIT
MOBILE TRANSFERGERÄTE
GTH 025 - GTH 060

 Pression de fonctionnement Working pressure Betriebsdruck	-	 Température de fonctionnement Working temperature Betriebstemperatur	-10 → +40 °C
 Débit Flow Strom	GTH 025 : 20 → 25 L/min GTH 060 : 50 → 60 L/min	 Seuil de filtration Micron rating Feinheit	3 → 90 µm
Moteur Motor Wechselstrommotor	GTH 025 : 750 W / 230 V / 50 Hz GTH 060 : 1600 W / 230 V / 50 Hz	Poids Weight Gewicht	26 kg
Fluide Fluid Flüssigkeit	Huile, Diesel Oil, Diesel fuel Öl, Diesel-Kraftstoff	Viscosité Viscosity Viskosität	20 → 500 cSt.
Hauteur de refoulement Lift height Förderhöhe	30 m max.	Humidité relative Relative humidity Relative Luftfeuchtigkeit	90% max.
		Niveau de bruit Noise level Geräuschpegel	< 70 dB
		Tuyau Hose Schlauch	IN : L = 2 m / Ø = 20 mm OUT : L = 2.5 m / Ø = 20 mm
		Normes Regulations Richtlinien	EN 292-2 / EN 294 / EN 50081-1 / EN 50082-1 EN 55014 / CEI EN 60034-1 / CEI EN 60034-5 DPR 547-55

N° Hifi	Dimensions Abmessungen mm	 Cartridges		
		N° Hifi	µm	 Media
GTH 025P10Z003A GTH 060P10Z003A	670 X 310 X 330	SH 63700	3	Fibre de verre / Fiber glass / Glasfaser
		SH 63701	6	
		SH 76855	10	
		SH 63711	25	
		SH 63061 (STD)	10	Cellulose / Zellulose
		SH 63063	25	
		SH 63066	60	
		SH 63077	90	Toile métallique / Steel wire mesh / Metallgewebe
		SH 63182	10	Absorbeur d'eau / Water absorber / Wasserabsorber
		SH 63183	25	

FR
EN
DE
GROUPE MOBILE DE TRANSFERT
MOBILE TRANSFER UNIT
MOBILE TRANSFERGERÄTE

GTH 025 - GTH 060

ACCESSOIRES | ACCESSORIES | ZUBERHÖR

	Désignation / Description / Beschreibung	N° Hifi
	Interrupteur Switch Schalter	HF 16657000
	Filtre d'aspiration Suction strainer Saugfilter	SH 77821
	Couvre-hélice de ventilation Fan blade protection cover Ventilatorschutz für Belüftung	HF 008182000
	Boîtier électrique Electric box Elektrisches Gehäuse	HF 1060008196
	Indicateur de colmatage Clogging indicator Verstopfungsanzeiger	HF 1014733000
	Raccord Adapters Anschlüsse	HF 1010824000
	Mamelon 1" BSP / Ø 25 mm Nipple 1" BSP / Ø 25 mm Nippel 1" BSP / Ø 25 mm	HF 1007764000
	KIT : 5 Palettes et 5 ressorts KIT : 5 Pallets and 5 springs KIT : 5 Paletten und 5 Feder	KIT PLREV70 (GTH 025) KIT PLREV90 (GTH 060)
	KIT tuyau refoulement Reversal hose KIT Rücklaufschlauch KIT	HF 1014019000
	KIT tuyau aspiration Suction hose KIT Ansaugschlauch KIT	HF 1014018000
-	Roue Wheel Rad	HF 1060005966
-	Joint Gasket Dichtung	JR 068520262 B
	Joint Gasket Dichtung	HF 1008772000
-	Moteur Motor Motor	F00303M00
-	Rotor Rotor Rotor	HF 10007825000 (GTH 025P10Z003A only)
-	Fixation roue Wheel fastening Radbefestigung	HF 1060008096



DISTRIBUTION CARBURANT FUEL DISPENSING KRAFTSTOFFBETANKUNG

DISTRIBUTION CARBURANT

FUEL DISPENSING
KRAFTSTOFFBETANKUNG

154

FILTRES À CARBURANT ABSORBANT L'EAU

FUEL FILTER WATER ABSORBING
WASSERABSORBER-KRAFTSTOFFFILTER

156

GROUPE MOBILE DE FILTRATION

MOBILE FILTRATION UNIT
MOBILE ÖLREINIGUNGSGERÄTE

158



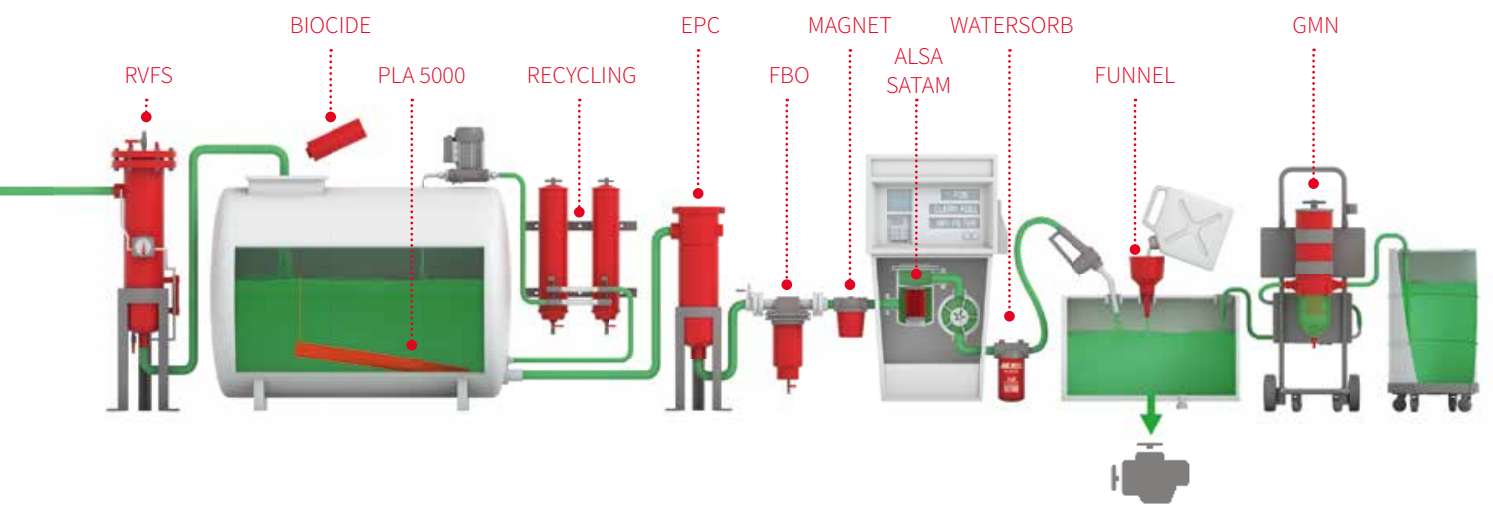

FR
EN
DE

**FILTRES À CARBURANT ABSORBANT L'EAU
FUEL FILTER WATER ABSORBING
WASSERABSORBER-KRAFTSTOFFFILTER**

WATERSORB



Pour / For / Für



Disponible pour Biodiesel
Available for Biodiesel
Verfügbar für Biodiesel

FR

Montés principalement sur les pompes manuelles ou électriques pour le ravitaillement mobile et fixe, sur les chantiers, ateliers ou marinas, les filtres à carburants absorbant l'eau offrent la solution idéale pour protéger les moteurs à la source. Ces filtres pour le **gasoil et l'essence** retiennent non seulement les saletés, poussières, rouilles et micro-organismes biologiques jusqu'à 10 µm, mais absorbent intégralement l'eau contenue dans le carburant. Le média absorbant fonctionnant sur le même principe qu'une couche culotte peut absorber jusqu'à 25 fois son poids en eau et se bloque une fois gavé. Comme le média gonfle en absorbant l'eau, le débit réduit graduellement indiquant le besoin de remplacer la cartouche. L'absence de bipasse assure une protection complète du système à carburant. Monté uniquement au refoulement, ce filtre se monte de façon verticale mais aussi horizontale.

EN

Principally installed on electrical or manual, fix or mobile dispensing units, in the field, workshops or marinas, the water absorbing filters offer the ideal solution to protect the engines at source. This **diesel and petrol** filter will not only retain dirt, dust, rust and biological microorganisms up to 10 µm, but also absorb completely all water droplets in fuel. The water absorbing media works the same way like a diaper and can absorb up to 25 time its weight in water and locks it in. As the media swells up by absorbing the water from the fuel, it gradually reduces the flow rate, indicating the need to replace the filter element. The absence of bypass valve insures a complete protection of the fuel system. Must be mounted only on pressure side, this filter can be used vertically and also horizontally.

DE

Hauptsächlich auf manuellen oder elektrischen Pumpen montiert, für das mobile oder stationäre Betanken auf Baustellen, in Werkstätten oder Bootshäfen. Die absorbierenden Filter bieten eine ideale Lösung, um die Motoren von Grund auf zu schützen. Diese Filter für **Diesel und Benzin** halten nicht nur Verschmutzungen, Staub, Rost und biologische Mikroorganismen bis 10 Mikron zurück, sondern absorbieren auch vollständig das Wasser, das im Treibstoff enthalten ist. Das absorbierende Filtrationsmittel, das auf dem Prinzip einer Windel basiert, kann bis 25 mal sein Gewicht in Wasser absorbieren und blockiert, sobald es voll ist. Da sich das Filtrationsmittel durch die Absorption ausdehnt, reduziert sich der Strom allmählich und zeigt an, wann die Patrone zu ersetzen ist. Das Nichtvorhandensein eines By-Passes sichert eine vollständige Schützung des Treibstoff-Systems. Wird vorzugsweise für Rückstau montiert. Dieses Filter kann vertikal wie auch horizontal montiert werden.





TÊTES | HEADS | KOPF



Type	N° Hifi	Flow L/min	Port sizes In / Out BSP	Port sizes Center BSP	Hauteur Height Höhe mm	Longueur Length Länge mm	Weight kg	Port sizes Jauge / Gauge / Anzeiger BSP	By-pass
1	DAR 11132 Z	50	3/4"	1"-12 UNF	48	95	0.3	No	No
	DAR 12832 Z	65	1"		48	95	0.3	No	No
2	DAR 12850 Z	80	1"	1" 1/2-16 UNF	48	95	0.3	No	No
3	DAR 24550 Z	150	1" 1/2	1" 1/2-16 UNF	65	135	0.8	No	No
	DAR 54599 ZD	380	1" 1/2		80	285	2.75	Yes	No

FR
EN
DE
FILTRES À CARBURANT ABSORBANT L'EAU
FUEL FILTER WATER ABSORBING
WASSERABSORBER-KRAFTSTOFFFILTER
WATERSORB

CARTOUCHES | CARTRIDGES | EINSATZ

Type Tête Head Kopf	N° Hifi	µm	Flow L/min	Port sizes (Center)	Ø mm	Hauteur Height Höhe mm	Weight kg	Absorbtion d'eau Water capacity Wasserabsorbierung ml	Pressure (max.) bar	Commentaires Comments Kommentare
1	SN 40627	10	50	1"-12 UNF	95	137	0,5	130	3,4	
	SN 55021	30	50		95	137	0,5	130	3,4	
	SN 55081	10	65		95	225	0,7	260	3,4	
	SN 55022	30	65		95	225	0,7	260	3,4	
	SN 55085	2	70		95	213	0,7	260	3,4	 Biodiesel
	SN 55025	10	70		95	213	0,7	260	3,4	 Biodiesel
2	SN 40607	10	80	1" ½-16 UNF	95	148	0,6	135	3,4	
	SN 40094	30	80		95	148	0,6	135	3,4	
	SN 40258	10	90		95	213	0,7	230	3,4	
	SN 40247	30	90		95	213	0,7	230	3,4	
	SN 40181	10	120		95	268	0,9	310	3,4	
	SN 40114	30	120		95	268	0,9	310	3,4	
	SN 40811	10	80		95	148	0,6	135	3,4	 Biodiesel
3	SN 55084	10	150	1" ½-16 UNF	128	270	1,25	540	3,4	
	SN 55023	30	150		128	270	1,25	540	3,4	
	SN 40221	2	110		128	270	1,25	540	3,4	 Biodiesel
	SN 55024	10	110		128	270	1,25	540	3,4	 Biodiesel

INDICATEURS DE COLMATAGE | CLOGGING INDICATORS | VERSCHMUTZUNGSANZEIGER

INR 040503 M



FR
EN
DE
GROUPE MOBILE DE FILTRATION
MOBILE FILTRATION UNIT
MOBILE DIESEL REINIGUNGSGERÄTE
GMN 025
Débit
Flow
Strom

25 L/min

Seuil de filtration
Micron rating
Feinheit

 30 µm
Option¹ : 2, 10, 150 µm
Moteur (électrique)
Motor (electric)
Wechselstrommotor (elektrisch)

230 V / 50 Hz

Poids
Weight
Gewicht

14 kg

Fluide
Fluid
Flüssigkeit

 Gasoil
 Diesel
 Fuel

N° Hifi	Dimensions Abmessungen mm			 Cartridges N° Hifi				
	Hauteur Height Höhe	Largeur Width Breite	Épaisseur Depth Tiefe	2 µm	10 µm	10 µm (Longlife)	30 µm	150 µm
GMN 025S30Z003Z	980	400	480	SN 920202	SN 920210	SN 925210	SN 920230	SN 920249

1. À commander séparément / To be ordered separately / Separat zu bestellen



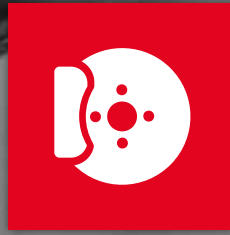

FREINAGE BRAKING BREMSEN

SYSTÈMES DE FREINAGE PNEUMATIQUE
PNEUMATIC BRAKING SYSTEMS
DRUCKLUFTBREMSANLAGEN

162





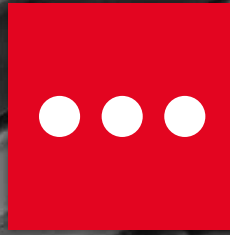

**PRODUITS COMPLÉMENTAIRES
ADDITIONAL PRODUCTS
ZUSATZPRODUKTE**

ABSORBANTS
ABSORBENTS
ABSORPTIONSMITTEL

166

FR
EN
DE

**ABSORBANTS
ABSORBENTS
ABSORPTIONSMITTEL**



Gammes / Range / Bandbreite			
	G	B	C
FR	Gris : Tous liquides (solubles, vernis, diluants, peintures, eau...)	Bleu ou Blanc : Hydrocarbures = Hydrophobe et oléophile (Huiles, graisses et ses dérivés hormis l'eau)	Jaune : Chimiques (PH 1 à 3 pour les acides)
EN	Grey : All liquids (dissolvable, varnish, thinner, paint, water)	Blue or White : Hydrocarbon = water-repellent and oleophilic (oil, grease and derivatives except water)	Yellow : Chemical substances (PH 1-3 for acids)
DE	Grau : Alle Flüssigkeiten (auflösbar, Lackmittel, Verdünnungsmittel, Farbe, Wasser...)	Blau oder weiss : Kohlenwasserstoff = Hydrophob und Oleophil (Öle, Fette und deren Derivate, ausgenommen Wasser)	Gelb : Chemikalien (PH 1 bis 3 für die Säuren)

FR Simple ou double épaisseur :

- Simple épaisseur : capacité d'absorption moindre (préventions, égoutures...).
- Double épaisseur : capacité d'absorption supérieure (traitement de pollution).

EN Single or double thickness :

- Single thickness: lower preventive capacity of absorption drippings...
- Double thickness: higher capacity of absorption (pollution treatment).

EN Einfache oder doppelte Dicke :

- Einfache Dicke: geringe Absorptionskapazität (triefend)...
- Doppelte Dicke: hohe Absorptionskapazität (Verschmutzungsbehandlung).

FR
EN
DE
ABSORBANTS
ABSORBENTS
ABSORPTIONSMITTEL
MÉDIAS ABSORBANTS | ABSORBENT MEDIA | ABSORPTIONSMEDIA









	Caractéristiques Characteristics Eigenschaften	Dimensions Abmessungen	Unité(s) Unit(s) Einheiten	Absorption ¹ L	N° Hifi			
					G	W	C	
CARTON DÉVIDOIR AVEC ROULEAU - DISPENSER BOX WITH REEL - SPENDER-BOX MIT ROLL								
	Double épaisseur Double thickness Doppelte Dicke	25 m x 40 cm	1	48	AB CDG01	-	-	
FEUILLES - SHEETS - BLÄTTER								
	Simple épaisseur Simple thickness Einfache Dicke	40 x 50 cm	200	135	AB FEG01	AB FEW01	AB FEC01	
	Double épaisseur Double thickness Doppelte Dicke	40 x 50 cm	100	100	AB FEG02	AB FEW02	AB FEC02	
	Spécial Maritime Spécial Maritime Für Bootswerften/Schifffahrt	40 x 50 cm	100	113	-	AB FEW03	-	
	Double épaisseur Double thickness Doppelte Dicke	30 x 30 cm	25	13	-	AB FEW04	-	
ROULEAUX - ROLLS - ROLLEN								
	Haute résistance High resistance Hohe Widerstandsfähigkeit	40 m x 80 cm	1	162	AB RLG01	AB RLB01	-	
		40 m x 40 cm	1	81	AB RLG02	AB RLB02	-	
		23 m x 38 cm	1	52	-	AB RLB03	-	
BOUDINS - FLANGES - SCHLANGEN								
	Boudins Flanges Schlangen	Ø 8 cm x 3 m	1	17.5	AB BDG01	AB BDW01 (x8)	-	
		Ø 8 cm x 18 m découpable/cuttable	1	105	AB BDG02	-	-	
TAPIS - CARPET - TEPPICH								
	Double épais. - Film étanche Doublethickness - Waterproofwrap Doppelte Dicke - Sperrschicht	80 cm x 60 cm	20	49	AB TPG01	AB TPW01	-	
	Simple épaisseur Simple thickness Einfache Dicke	30 m x 1.5 m	1	160	AB TPG02	-	-	
		Double épaisseur Double thickness Doppelte Dicke	30 m x 0.80 m	1	123	-	AB TPW02	-
			30 m x 1.6 m	1	246	AB TPG03	-	-
BANDETTES - STRIP - STREIFEN								
	Box : 25 kg Box : 10 kg	-	2	875	-	AB HYFVRAC01	-	
		7 x 50 mm	1	197	-	AB HYFVRAC02	-	
BARRAGES - DAMS - EINDÄMMUNGEN (SPERREN)								
	Barrages Dams Eindämmungen	Ø 13 cm x 3 m	4	231	-	AB BRW01	-	
		Ø 13 cm x 5 m	2	191	-	AB BRW02	-	
		Ø 20 cm x 3 m	4	456	-	AB BRW03	-	
		Ø 20 cm x 5 m	2	378	-	AB BRW04	-	
COUSSINS & SURFÛTS - CUSHIONS & DRUM TOP - KISSEN & ÜBERFÄSSER								
	Coussins pour fosse Cushions for pit Kissen für Grube	Ø 20 cm x 1 m	4	98	-	AB CSW02	-	
		30 x 60 cm	1	20	-	AB CSW01	-	
		23 x 23 cm	20	50	-	AB CSW03	-	
		46 x 46 cm	1	11	-	AB CSW04	-	
	Pour fûts 200/220 L For drums 200 / 220 L Für Fässer von 200/220 L	Ø 56 cm	1	1.3	AB SFG01	-	-	
	Pour fûts 60 L For drums 60 L Für Fässer von 60 L	Ø 34 cm	1	0.8	AB SFG02	-	-	

Le volume d'absorption (en L) est donné à titre indicatif et peut varier sensiblement.

1. The Absorption Capacity (in Liter) is indication only and could change considerably.
Das Absorptionsvolumen (in Liter) dient als Angabe und kann beträchtlich variieren.

FR
 EN
 DE

ABSORBANTS
ABSORBENTS
ABSORPTIONSMITTEL
ABSORBANTS MINÉRAUX ET VÉGÉTAUX | MINERAL AND VEGETABLE BASED ABSORBENTS | MINERALISCHE UND PFLANZLICHE ABSORPTIONSMITTEL

Caractéristiques Characteristics Eigenschaften	Conditionnement Contidioning Verpackung	Poids / Volume Weight / Volume Gewicht / Volumen	N° Hifi	
			G	W
TERRE DE DIATOMÉE - DIATOMACEOUS EARTH - KIESELERDE				
Homologuée usage routier - routes, usines, aéroport, ateliers... Homologated for roads, plants, airports, workshops... Homologiert für Strasse - Werke - Flughafen - Werkstätte...		10 kg	SVP 01000 DIA	-
		20 kg	SVP 02000 DIA	-
ATTAPULGITE - ALUMINIUM/MAGNESIUMHYDRAT				
Homologuée usage routier - intérieur / extérieur Homologated for roads, interior and exterior Homologiert für Strasse, Innen- und Aussenanwendung		10 kg	SVP 01000 ATA	-
		20 kg	SVP 02000 ATA	-
ABSORBANT VÉGÉTAL IGNIFUGÉ - FIREPROOF VEGETABLE ABSORBENT - PFLANZLICHES FEUERFESTES ABSORPTIONSMITTEL				
Utilisation en milieu industriel - biodégradable Industrial application - biodegradable Anwendung im industriellen Bereich - biologisch abbaubar		30 L	SVL 03000 VIG	-
		40 L	SVL 04000 VIG	-
Agréé alimentaire Nutrition approved Für Lebensmittelbereich homologiert		40 L	SVL 04000 VIA	-
ABSORBANT VÉGÉTAL HYDROCARBURES - HYDROCARBON VEGETABLE ABSORBENT - PFLANZENÖL ABSORBIERENDER KOHLENWASSERSTOFF				
Milieus naturels - sur sols comme sur eau Natural environment - on water and on ground Natürliche Umgebung - auf dem Boden wie auf Wasser		50 L	-	SVL 05000 VIW
SEPIOLITE - MAGNESIUMHYDRAT (MEERSCHAUM)				
Utilisation dans les usines, aéroports, ateliers, bateaux... Application for plants, airports, workshops and marine... Verwendung in Werken, Flughäfen, Werkstätten und Schiffen...		20 kg	SVP 02000 SEP	-
TOURBE ABSORBANTE HYDROFUGE - WATER-REPELLENT ABSORBENT PEAT - WASSERABSTOSSENDES BINDEMittel				
Intérieur / extérieur - sur sols comme sur eau Interior and exterior - on water and on ground Innen- und Aussenanwendung - auf dem Boden wie auf Wasser		50 L	-	SVL 05000 TOU



FR
 EN
 DE

ABSORBANTS
ABSORBENTS
ABSORPTIONSMITTEL
KITS D'INTERVENTION D'URGENCE | EMERGENCY INTERVENTION KIT | NOTFALL-EINSATZ SET

	FR	EN	DE	Absorption L	N° Hifi G ¹
	Contenu	Content	Inhalt		
SAC HOUSSE PVC - PVC BAG COVER - ABDECKUNG AUS PLASTIK					
	- 30 feuilles 30 x 30 cm - 1 boudin Ø 8 x 120 cm - 5 essuyeurs 32 x 40 cm - 1 paire de gants - 2 sacs de récupération 30 L	- 30 sheets 30 x 30 cm - 1 flange Ø 8 x 120 cm - 5 wipes 32 x 40 cm - 1 pair of gloves - 2 collecting bags 30 L	- 30 Blätter 30 x 30 cm - 1 Schlange Ø 8 x 120 cm - 5 Matten 32 x 40 cm - 1 Paar Schutzhandschuhe - 2 Säcke zu 30 l	20	AB KTG20 (330x320x180 mm) (1.425 kg)
	- 35 feuilles 40 x 50 cm - 2 boudins Ø 8 x 120 cm - 10 essuyeurs 32 x 38 cm - 1 paire de gants - 2 sacs de récupération 50 L	- 35 sheets 40 x 50 cm - 2 flanges Ø 8 x 120 cm - 10 wipes 32 x 38 cm - 1 pair of gloves - 2 collecting bags 50 L	- 35 Blätter 40 x 50 cm - 2 Schlangen Ø 8 x 120 cm - 10 Matten 32 x 38 cm - 1 Paar Schutzhandschuhe - 2 Säcke zu 50 l	50	AB KTG50 (570x470x230 mm) (2.765 kg)
	- 50 feuilles 40 x 50 cm - 2 boudins Ø 8 x 120 cm - 1 coussin 40 x 40 cm - 10 essuyeurs 32 x 38 cm - 1 paire de gants - 3 sacs de récupération 50 L	- 50 sheets 40 x 50 cm - 2 flanges Ø 8 x 120 cm - 1 cushion 40 x 40 cm - 10 wipes 32 x 38 cm - 1 pair of gloves - 3 collecting bags 50 L	- 50 Blätter 40 x 50 cm - 2 Schlangen Ø 8 x 120 cm - 1 Kissen 40 x 40 cm - 10 Matten 32 x 38 cm - 1 Paar Schutzhandschuhe - 3 Säcke zu 50 l	70	AB KTG70 (520x480x280 mm) (5.300 kg)
CAISSE AVEC ROULETTES - BOX WITH WHEELS - KISTE MIT RÄDERN					
	- 300 feuilles 40 x 50 cm - 2 rouleaux 0.40 x 40 m - 10 boudins Ø 8 x 300 cm - 20 coussins 40 x 40 cm - 50 essuyeurs 32 x 38 cm - 2 paires de gants - 1 paire de lunettes - 1 combinaison - 16 Sacs de récup. 100 L	- 300 sheets 40 x 50 cm - 2 rolls 0.40 x 40 m - 10 flanges Ø 8 x 300 cm - 20 cushion 40 x 40 cm - 50 wipes 32 x 38 cm - 2 pairs of gloves - 1 pair of goggles - 1 overall - 16 collecting bags 100L	- 300 Blätter 40 x 50 cm - 2 Rollen 0.40 x 40 m - 10 Schlangen Ø 8 x 300 cm - 20 Kissen 40 x 40 cm - 50 Matten 32 x 38 cm - 2 Paar Schutzhandschuhe - 1 Brille - 1 Kombianzug - 16 Säcke zu 100 l	800	AB KTG800
BIG BAG FILTRANT - BIG FILTERING BAG - GROSSER TASCHEN-FILTER					
	Big bag filtrant 150 µm. Toile en polypropylène ventilée 180 gr/m ² (Traitement anti-UV).	Big filtering bag 150 µm. Ventilated 180 gr/m ² polypropylene cloth (treated anti UV)	Grosser Taschen-Filter 150 µm aus belüftetem Polypropylen 180 gr/ m ² (Anti-UV behandelt)	-	PL 1633 (950x950x1100 mm)
	Support big bag avec bac de rétention 225 L.	Big bag stand	Halterung für Grossen Taschen Filter	-	SUPBIGBAGARL

Sur demande, kits spécifiques applications hydrocarbures et produits chimiques.

1. On request: specific kits for hydrocarbon applications and chemical products
 Auf Wunsch: Spezifische Kits für Kohlenwasserstoff-Anwendungen und chemische Produkte.

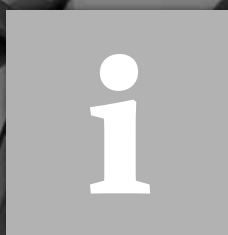

INFORMATIONS & INDEX INFORMATION & INDEX INFORMATIONEN UND INDEX

SIGNIFICATION PICTOGRAMMES MEANING OF PICTOGRAMS BEDEUTUNG DER PIKTOGRAMME	173
CODIFICATIONS CODIFICATION LEGENDE	174
COMMENTAIRES COMMENTS KOMMENTARE	176
INDEX INDEX INDEX	183
RECOMMANDATIONS GÉNÉRALES GENERAL ADVICES ALLGEMEINE ERKLÄRUNGEN	186

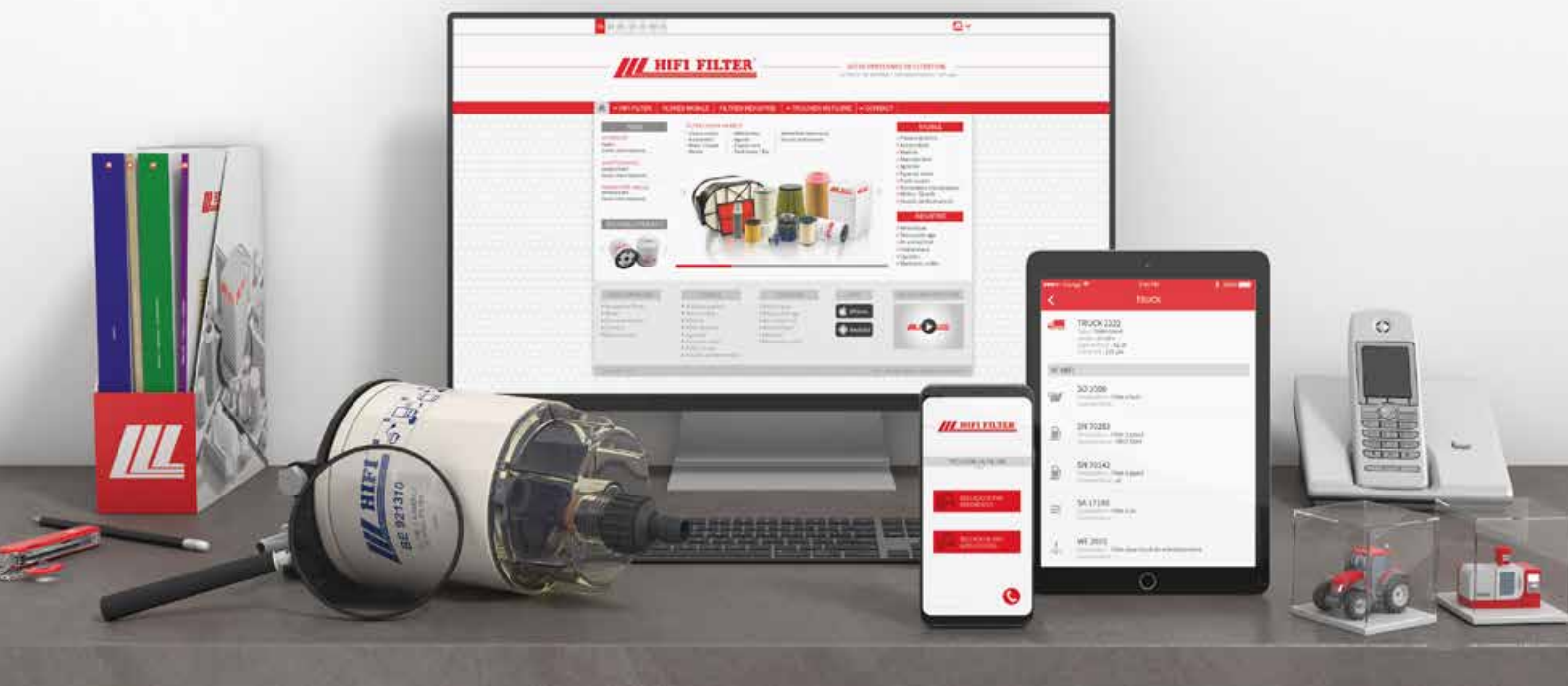

**TROUVER UN FILTRE
FIND A FILTER
FILTER FINDEN**



hifi-filter.com



**Catalogues
Catalogues
Katalog**













**APPS
iPhone & Android**



**Conseil technique
Technical advise
Technische Beratung**

 Pour connaître les dernières références de nos catalogues, rendez-vous sur hifi-filter.com
In order to know the last references of our catalogues, you can visit our website hifi-filter.com
Um die letzten Referenzen unserer Kataloge zu kennen, können Sie unsere Internetseite hifi-filter.com besuchen.

SIGNIFICATION PICTOGRAMMES MEANING OF PICTOGRAMS BEDEUTUNG DER PIKTOGRAMME

	FR	EN	DE	ES	IT	RO	PL
	Raccordement	Ports sizes	Anschluß	Conexión	Raccordi	Racord	Rozmiar przyłącza
	Pression de fonctionnement	Working pressure	Betriebsdruck	Presión de funcionamiento	Pressione di esercizio	Presiunea de lucru	Ciśnienie robocze
	Débit	Flow	Strom	Caudal	Portata	Debit	Przepływ
	Média	Media	Medien	Medio	Setto oppure Media	Material	Material filtracyjny
	Seuil de filtration	Micron rating	Feinheit	Umbral de filtración	Grado di filtrazione	Finete	Stopień filtracji
	Diamètre	Diameter	Durchmesser	Diámetro	Diametro	Diametru	Srednica
	Poids	Weight	Gewicht	Peso	Peso	Greutate	Waga
	Température de fonctionnement	Working temperature	Betriebstemperatur	Temperatura de funcionamiento	Temperatura di esercizio	Temperatura de lucru	Temperatura robocza
	Valve by-pass	By-pass	By-pass Ventil	Válvula by-pass	Valvola by-pass	By-pass	By-pass
	Dimensions	Dimensions	Abmessungen	Medidas	Dimensioni	Dimensiuni	Wymiary
	Maintenance	Maintenance	Unterhalt	Mantenimiento	Manutenzione	Perioada pina la inlocuire	Konserwacja
	Surface de filtration	Filtering surface	Filtrierende Fläche	Superficie de filtración	Superficie di filtrazione	Suprafata filtranta	Powierzchnia filtracji
	Efficacité	Efficiency	Leistung	eficiencia	Efficienza	Eficacitate	Wydajność
	Filtre complet	Complete filter	Komplettfilter	Filtro completo	Filtro completo	Filtru complet	Filtr kompletny
	Boîtier	Housing	Gehäuse	Carcasa	Porta filtro	Carcasa	Obudowa
	Cartouche	Cartridge	Elementen	Cartucho	Cartuccia	Cartus	Wkład
	Perte de charge	Pressure drop	Druckabfall	Caída de presión	Calo di pressione	Cadere de presiune	Spadek ciśnienia
	Réservoir	Tank	Tank	Depósito	Serbatoio	Rezervor	Zbiornik
	Pompe	Pump	Pumpe	Bomba	Pompa	Pompa	Pompa



CODIFICATIONS CODIFICATION LEGENDE

CODE HIFI	FR CODIFICATION	EN CODIFICATION	DE LEGENDE	ES CODIFICACIÓN	IT CODIFICAZIONE	RO CODIFICACIÓN	PL KODYFIKACJA
ASP... ASR...	Filtre dépoussiérage	Dusting filter	Entstaubungsfilter	Filtro de desempolvamiento	Filtro depolverazione	Filtru desprăfuire	Filtr odpylający
BE...	Filtre à essence	Petrol/gasoline filter	Benzinfilter	Filtro de gasolina	Filtro da benzina	Filtru benzină	Filtr benzyny
CL...	Clé à filtre	Filter wrench	Filterschlüssel	Llave para filtro	Chiave per filtro	Cheie filtru	Klucz do filtra
CR...	Filtre Hydraulique retour	Return hydraulic filter	Rücklauf-Hydraulikfilter	Filtro hidráulico de retorno	Filtro idraulico di ritorno	Filtru hidraulic retur	Filtr hydrauliczny powrotny
DY...	Déshydrateurs de climatisation	A/C dryer	Trockner für Klimaanlage	Deshidratador de climatización	Filtro desidratatore per climatizzatori	Filtru dezumidificator instalatie aer	Osuszacz klimatyzacji
EAP...	Filtre Piscine	Swimming pool filter	Schwimmbadfilter	Filtro de piscina	Filtro per piscina	Filtru apă	Filtr basenowy
EL...	Filtre électroérosion	Spark erosion filter	Elektroerosionsfilter	Filtro de electro erosión	Filtro ellettroerosione	Filtru electro-eroziune	Filtr do elektroerozji
EZ...	Filtre pour liquide	Filter for liquids	Filter für flüssigkeit	Filtro para líquidos	Filtro per liquidi	Filtru de lichide	Filtr do płynów
FS...	Filtre Aération Réservoir	Tank vent air breather	Tankentlüftungsfilter	Filtro de ventilación de depósito	Filtro di aerazione per serbatoio	Filtru aerisire rezervor	Filtr przewietrzania zbiornika
FT...	Filtre à gasoil/Diesel	Diesel fuel filter	Kraftstofffilter	Filtro de gasoil/ Diesel	Filtro da gasolio	Filtru motorină/ Diesel	Filtr oleju napędowego / Diesel
JO...	Joint plat	Flat gasket	Flachdichtung	Junta plana	Guarnizione piatta	Garnitură plata	Uszczelka płaska
JR...	Joint o-ring	O-ring gasket	O-Ring-Dichtung	Junta oring	Guarnizione o-ring	Garnitură o-ring	Uszczelka o-ring
KA...	Kit filtre à air	Air filter kit	Luftfilter Kit	Kit filtro de aire	Kit filtro a aria	Kit filtru de aer	Filtr powietrza-zestaw
KAO...	Kit filtre aération moteur	Engine breather filter kit	Motorentlüftungsfilter Kit	Kit filtro aireación motor	Kit filtro sfiato motore	Kit filtru ventilatie motor	Filtr odmy silnika-zestaw
KE...	Kit filtre essence	Petrol/gasoline filter kit	Benzinfilter Kit	Kit filtro de gasolina	Kit filtro da benzina	Kit filtru benzină	Filtr benzyny-zestaw
KH...	Kit filtre hydraulique	Hydraulic filter kit	Hydraulikfilter Kit	Kit filtro hidráulico	Kit filtro idraulico	Kit filtru hidraulic	Filtr hydrauliczny-zestaw
KM...	Kit de maintenance	Maintenance kit	Wartungs-Kit	Kit mantenimiento	Kit manutenzione	Kit intretinere	Zestaw serwisowania
KN...	Kit filtre à gasoil	Fuel filter kit	Dieselfilter Kit	Kit filtro de gasoil	Kit filtro a gasolio	Kit filtru de motorina	Filtr paliwa-zestaw
KO...	Kit filtre à huile	Oil filter kit	Oelfilter Kit	Kit filtro de aceite	Kit filtro a olio	Kit filtru de ulei	Filtr oleju-zestaw
MO...	Préfiltre et filtre à gasoil complet	Complete Diesel fuel prefilter and filter	Kraftstofffilter: Vor- und Kompletfilter	Pre filtro y filtro de gasoil completo	Prefiltro e filtro da gasolio completo	Prefiltru și filtru motorină complet	Filtr wstępny i filtr kompletny oleju napędowego
OA... OD... OE... OS... OT... OV...	Séparateur air/huile	Air / Oil separator	Luft- / Öl-Abscheider	Separador aire/ aceite	Separatore ad aria	Separator aer/uilei	Separator powietrza/olej
PL...	Poche liquide	Liquid bag filter	Filterbeutel zur Flüssigkeitsfiltration	Bolsa para liquido	Sacca a liquidi	Buzunar lichid	Filtry workowe do płynów
SA...	Filtre à air	Air filter	Luftfilter	Filtro de aire	Filtro ad aria	Filtru aer	Filtr powietrza
SAB... SAC... SAD...	Filtre à air série Duralite	Duralite air filter	Duralite Luftfilter	Filtro de aire serie Duralite	Filtro ad aria serie Duralite	Filtru aer seria Duralite	Filtr powietrza serii Duralite

CODE HIFI	FR CODIFICATION	EN CODIFICATION	DE LEGENDE	ES CODIFICACIÓN	IT CODIFICAZIONE	RO CODIFICACIÓN	PL KODYFIKACJA
SAO...	Filtre aération moteur	Crankcase ventilation	Motorenlüftungsfilter	Filtro de ventilación motor	Filtro aerazione motore	Filtru aerisire motor	Filtr przewietrzania silnika
SAOH...	Filtre aération moteur complet	Complete crankcase ventilation	Motorenlüftungs Kompletfilter	Filtro de ventilación motor completo	Filtro aerazione motore completo	Filtru aerisire motor complet	Filtr kompletny przewietrzania silnika
SAM...	Masse filtrante	Filtering mass	Filtriermasse	Masa filtrante	Massa filtrante	Masa de filtrare	Materiał filtracyjny
SC...	Filtre cabine ou habitacle	Cabin filter	Innenraumfilter	Filtro de cabina o habitaculo	Filtro di abitacolo	Filtru cabină sau habitaculu	Filtr kabinowy
SC...CA	Filtre habitacle charbon actif imprégné	Impregnated active carbon cabin filter	-	-	-	-	-
SC...CAB	Filtre habitacle antibactérien	Antibacterial cabin filter	Bakterielle Innenraumfilter	Filtro de habitaculo antibacteriano	Filtri abitacolo antibatterici	Filtru polen antibacterian	Filtr kabinowy antybakteryjny
SC.CAG	Filtre habitacle charbon actif granulé	Active carbon cabin filter	Kabinen-Aktivkohlefilter	Filtro de cabina de carbón activo	Filtro da abitacolo in carbone attivo	Filtru polen carbon activ	Filtr kabinowy z węglem aktywnym
SD...	Filtre à urée	Urea filter	Harnstofffilter	Filtro de urea	Filtro urea	Filtru aditiv combustibil	Filtr mocznika
SF...	Filtre à air métallique	Metallic air filter	Metallischer Luftfilter	Filtro de aire metálico	Filtro ad aria in metallo	Filtru aer metalic	Filtr powietrza metalowy
SG...	Filtre à gaz	Gas filter	Gasfilter	Filtro de gas	Filtro a gas	Filtru gaz	Filtr gazu
SH...	Filtre hydraulique	Hydraulic filter	Hydraulikfilter	Filtro hidráulico	Filtro idraulico	Filtru hidraulic	Filtr hydrauliczny
SI...	Sécheur d'air	Air dryer	Lufttrockner	Secador de aire	asciugatura d'aria	Uscător de aer	Osuszacz powietrza
SN...	Filtre à gasoil/Diesel	Diesel fuel filter	Kraftstofffilter	Filtro de gasoil/ Diesel	filto da gasolio	Filtru motorină/ Diesel	Filtr oleju napędowego / Diesel
SO...	Filtre à huile	Oil filter	Ölfilter	Filtro de aceite	Filtro da olio	Filtru ulei	Filtr oleju
T...	Filtre à huile	Oil filter	Ölfilter	Filtro de aceite	Filtro da olio	Filtru ulei	Filtr oleju
TB...	Dessiccateurs de freins	Brakes desiccators	Lufttrockner-Patrone	Secador de frenos	Essicatori freni	Uscator frana	Osuszacze układu hamulców pneumatycznych
TCO...	Bouchon de réservoir	Tank cover	Tank-Verschluss	Tapa de depósito	Tappo per serbatoio	Bușon rezervor	Korek wlewu oleju
WE...	Filtre eau moteur	Engine water cooling filter	Motorwasserfilter	Filtro de agua motor	Filtro da acqua per il motore	Filtru lichid răcire	Filtr układu chłodzenia silnika
Y...	Accessoire pour filtre Racor	Accessories for Racor filter	Zubehör für Racor-Filter	Accesorio para filtro RACOR	Accessori per filtro RACOR	Accesorii pentru filtru RACOR	Aksesoria do separatora RACOR



CODE	DESCRIPTION
+	Le montage nécessite plusieurs filtres
ADDIT/ZUSATZ	Filtre monté par le constructeur en option
Aera/Vent	Affectation filtre aération ventilation
Air/Luft	Affectation filtre à air
Air1/Luft	Affectation filtre à air primaire
Air2/Luft	Affectation filtre à air secondaire
ANNEE/YEAR	Année de fabrication de la machine
ASP/SAUGFILT	Filtre monté à l'aspiration
AVEC/MIT BY-PASS	Filtre équipé d'un clapet by-pass
AVEC/MIT KLIM	Filtre pour montage avec climatisation
AVEC/MIT PREF/VORF	Filtre à air avec préfiltre cyclonique
AVEC/MIT TURBO	Filtre pour montage sur moteur turbo
BACT	Filtre habitacle antibactérien
BH/OILBADLUFT	Filtre à air à bain d'huile
BV 16	Filtre pour boîte de vitesse 16 rapports
BV 24	Filtre pour boîte de vitesse 24 rapports
BY-PASS	Filtre monté sur le circuit by-pass
C.A/A.K	Filtre charbon actif
CAB SPACIAL	®
Cabin air	Affectation filtre d'habitacle
CART/EINS	Filtre de type élément se montant dans une cuve
CCLS	®
CHAUF/HEINZUNG	Filtre pour système de chauffage
CLIM/KLIM	Filtre pour système de climatisation
COMP	Filtre pour compresseur
CREP/SAUGFILT	Crépine d'aspiration
CV/HP/PS	Puissance du moteur
DELUXE +	®
Dessic/Dr	Affectation filtre dessiccateur de freinage
Direc/Ste	Affectation filtre hydraulique de direction
DONALDSON	Montage système DONALDSON
Eau/Cool	Affectation filtre à eau circuit refroidissement moteur
FIBRE/FIBER	Filtre en média fibre de verre
FILETE/GEWINDE	Filtre avec un filetage
FREIN/BREMSE	Filtre pour système de freinage
Gasoil	Affectation filtre à gasoil
GO	Filtre pour réservoir gasoil
H:352 MM	Hauteur du filtre : 352 mm
HYD	Filtre pour réservoir hydraulique
Hydraulic	Affectation filtre hydraulique
HST	Filtre pour transmission hydrostatique
IN LINE	Filtre en ligne sur conduite
INT+EXT	Filtre intérieur + filtre extérieur
KLEENOIL	®
LINDE	®
LONG LIFE	Longue durée
LOW PROFILE +	®
LS	®
MANN	®
MEC	Filtre de boîte de vitesse mécanique
MOT/ENG	Filtre pour moteur
->MOT 516450	Jusqu'à numéro moteur 516450
MOT 516451->	A partir du numéro moteur 516451
MOT.MAKE	Marque du moteur
MOT.TYPE	Type du moteur
O: 98 MM	Diamètre du filtre : 98 mm
Oil/Oel	Affectation filtre à huile

CODE	DESCRIPTION
OPT.LS ECO	®
OPTION BY-COOL	®
OPTION ISC	®
OPTION LS	®
OU/ODER	OU - plusieurs montages possible
PDF AV/FRONTPTO	Filtre pour prise de force avant
Pilot	Affectation filtre hydraulique de pilotage
PPE	Filtre de pompe
PREF/VORF	Préfiltre
PRESSION/DRUCK	Filtre de pression
PRIM	Filtre primaire
REFROID/KUHL	Filtre pour système de refroidissement
RELEV/HAUB	Filtre pour système de relevage
RESERVOIR/TANK	Filtre dans réservoir
RETOUR/RUCK	Filtre de retour
REVERSHIFT	®
REXROTH	®
SANS PPE/OHNE PPE	Montage sans pompe
SANS/OHNE CLIM/KLIM	Montage sans climatisation
SAUER	®
SECON	Filtre secondaire
SERIE No	Numéro de série du véhicule
Trans/Get	Affectation filtre hydraulique de transmission
TURBO	Filtre pour turbo
TYPE CARR.	Spécification du véhicule
TYPE MACH.	Type machine
VACUUM SENSOR	Indicateur de dépression
VGT	Turbo à géométrie variable
VISSE/SCHR	Filtre vissé
X3	Nombre de filtres par montage

EN COMMENTS

CODE	DESCRIPTION
+	Mounting requires several filters
ADDIT/ZUSATZ	Optional filter mounted by OEM
Aera/Vent	Air vent / Breather filter application
Air/Luft	Air filter
Air1/Luft	Air primary filter
Air2/Luft	Air secondary (safety) filter
ANNEE/YEAR	Manufacturing year of the machine
ASP/SAUGFILT	Filter mounted on the suction side
AVEC/MIT BY-PASS	Filter with by-pass valve
AVEC/MIT KLIM	With air conditioning mounted
AVEC/MIT PREF/VORF	Air filter with cyclone prefilter
AVEC/MIT TURBO	Application for turbo charged engine
BACT	Antibacterial cabin filter
BH/OILBADLUFT	Oil bath air filter
BV 16	Gearbox 16 gears
BV 24	Gearbox 24 gears
BY-PASS	Filter mounted on by-pass circuit
C.A/A.K	Active carbon filter
CAB SPACIAL	®
Cabin air	Cabin filter
CART/EINS	Filter element «in bowl» type
CCLS	®
CHAUF/HEINZUNG	Filter for heating system
CLIM/KLIM	Filter for air conditioning system
COMP	Filter for air compressor
CREP/SAUGFILT	Suction strainer
CV/HP/PS	Engine power
DELUXE +	®
Dessic/Dr	Filter for air brake dessicant
Direc/Ste	Power steering filter
DONALDSON	Mounting on Donaldson system
Eau/Cool	Engine water cooling system filter
FIBRE/FIBER	Filter with fiber glass media
FILETE/GEWINDE	Filter with thread
FREIN/BREMSE	Braking system filter
Gasoil	Diesel fuel filter
GO	Filter for diesel tank
H:352 MM	Filter height : 352 mm
HYD	Filter for hydraulic tank
Hydraulic	Hydraulic filter
HST	Filter for hydrostatic transmission
IN LINE	In line filter
INT+EXT	Secondary + Primary filter
KLEENOIL	®
LINDE	®
LONG LIFE	Long life
LOW PROFILE +	®
LS	®
MANN	®
MEC	Manual gearbox filter
MOT/ENG	Engine filter
->MOT 516450	Up to engine serial number 516450
MOT 516451->	From engine serial number 516451
MOT.MAKE	Engine brand
MOT.TYPE	Engine type
O: 98 MM	Filter diameter : 98 mm
Oil/Oel	Oil filter

CODE	DESCRIPTION
OPT.LS ECO	®
OPTION BY-COOL	®
OPTION ISC	®
OPTION LS	®
OU/ODER	«Or» several mounting possible
PDF AV/FRONTPTO	Front «Power Take Off» filter
Pilot	Piloting hydraulic filter
PPE	Pump filter
PREF/VORF	Prefilter
PRESSION/DRUCK	Pressure filter
PRIM	Primary filter
REFROID/KUHL	Cooling system filter
RELEV/HAUB	Lifting system filter
RESERVOIR/TANK	In tank filter
RETOUR/RUCK	Return line filter
REVERSHIFT	®
REXROTH	®
SANS PPE/OHNE PPE	Mounting without pump
SANS/OHNE CLIM/KLIM	Mounting without air conditioning
SAUER	®
SECON	Secondary filter
SERIE No	Vehicle serial number
Trans/Get	Transmission hydraulic filter
TURBO	Filter for turbo
TYPE CARR.	Vehicle specification
TYPE MACH.	Machine type
VACUUM SENSOR	Vacuum sensor
VGT	variable-geometry turbo
VISSE/SCHR	spin-on filter
X3	Number of filter for this mounting



CODE	DESCRIPTION
+	Zwingender Einbau von mehreren Filtern
ADDIT/ZUSATZ	Herstelleroption für Filtereinbau
Aera/Vent	EntlüftungsfILTER
Air/Luft	Luftfilter
Air1/Luft	Primärluftfilter
Air2/Luft	Sekundärluftfilter
ANNEE/YEAR	Herstellungsjahr der Maschine
ASP/SAUGFILT	Ansaugfilter
AVEC/MIT BY-PASS	Filter mit Druckausgleichsventil
AVEC/MIT KLIM	Filter für Einbau mit Klimaanlage
AVEC/MIT PREF/VORF	Luftfilter mit Zyklonvorfilter
AVEC/MIT TURBO	Filter für Turbomotoren
BACT	Bakterielle Innenraumfilter
BH/OILBADLUFT	Ölbadfilter
BV 16	Filter für 16 Gang Getriebe
BV 24	Filter für 24 Gang Getriebe
BY-PASS	Nebenstromfilter
C.A/A.K	Aktivkohlenfilter
CAB SPACIAL	®
Cabin air	Kabinenfilter
CART/EINS	Filterelement für Gehäuse
CCLS	®
CHAUF/HEINZUNG	Filter für Heizung
CLIM/KLIM	Filter für Klimaanlage
COMP	Filter für Kompressor
CREP/SAUGFILT	Saugkörbe/ Saugfilter
CV/HP/PS	Motorenleistung
DELUXE +	®
Dessic/Dr	Bremslufttrocknungsfilter
Direc/Ste	Lenkungsfilter
DONALDSON	Einbausystem Donaldson
Eau/Cool	Motorkühlwasserfilter
FIBRE/FIBER	Glasfaserfilter
FILETE/GEWINDE	Filter mit Gewinde
FREIN/BREMSE	Filter für Bremssystem
Gasoil	Dieselfilter
GO	Filter für Dieseltank
H:352 MM	Filterhöhe: 352mm
HYD	Filter für Hydrauliköltank
Hydraulic	Hydraulikfilter
HST	Filter für Hydrostatikgetriebe
IN LINE	LeitungsfILTER
INT+EXT	Innen+ Aussenfilter
KLEENOIL	®
LINDE	®
LONG LIFE	Longlife
LOW PROFILE +	®
LS	®
MANN	®
MEC	Filter für Schaltgetriebe
MOT/ENG	Motorenfilter
->MOT 516450	Bis Motorennummer: 516450
MOT 516451->	Ab Motorennummer: 516451
MOT.MAKE	Motorenmarke
MOT.TYPE	Motorentyp
O: 98 MM	Filterdurchmesser: 98mm
Oil/Oel	Ölfilter

CODE	DESCRIPTION
OPT.LS ECO	®
OPTION BY-COOL	®
OPTION ISC	®
OPTION LS	®
OU/ODER	oder
PDF AV/FRONTPTO	Filter für Fronthydraulik (Dämpfung)
Pilot	Vorsteuerungsfilter
PPE	Pumpenfilter
PREF/VORF	Vorfilter
PRESSION/DRUCK	Druckfilter
PRIM	PrimärfILTER
REFROID/KUHL	Filter für Kühlsystem
RELEV/HAUB	Filter für Hebehydraulik
RESERVOIR/TANK	Tankfilter
RETOUR/RUCK	Rücklauffilter
REVERSHIFT	®
REXROTH	®
SANS PPE/OHNE PPE	Ohne Pumpe
SANS/OHNE CLIM/KLIM	Ohne Klimaanlage
SAUER	®
SECON	Feinfilter
SERIE No	Fahrzeugseriennummer
Trans/Get	Getriebefilter
TURBO	Filter für Turboversion
TYPE CARR.	Fahrzeugspezifikation
TYPE MACH.	Maschinentyp
VACUUM SENSOR	Unterdruckanzeiger
VGT	Variable Turbogometrie
VISSE/SCHR	Schraubfilter
X3	Anzahl Filter pro Einbau

CODE	DESCRIPTION
+	El montaje necesita varios filtros
ADDIT/ZUSATZ	Filtro montado en opción por el constructor
Aera/Vent	Afectación para filtros de aireación y ventilación
Air/Luft	Afectación para filtro de aire
Air1/Luft	Afectación para filtro de aire principal
Air2/Luft	Afectación para filtro de aire secundario
ANNEE/YEAR	Año de fabricación de la máquina
ASP/SAUGFILT	Filtro montado en aspiración
AVEC/MIT BY-PASS	Filtro equipado con una válvula by-pass
AVEC/MIT KLIM	Filtro para instalación con aire acondicionado
AVEC/MIT PREF/VORF	Filtro de aire con pre filtro ciclónico
AVEC/MIT TURBO	Filtro para instalación con motor turbo
BACT	Filtro de habitáculo antibacteriano
BH/OILBADLUFT	Filtro de aire de baño de aceite
BV 16	Filtro para caja de cambios de 16 velocidades
BV 24	Filtro para caja de cambios de 24 velocidades
BY-PASS	Filtro montado en el circuito by-pass
C.A/A.K	Filtro de carbón activo
CAB SPACIAL	®
Cabin air	Afectación filtro de cabina
CART/EINS	Filtro de tipo elemento montado en un recipiente
CCLS	®
CHAUF/HEINZUNG	Filtro para sistema de calefacción
CLIM/KLIM	Filtro para sistema de aire acondicionado
COMP	Filtro para compresor
CREP/SAUGFILT	Alcachofa de aspiración
CV/HP/PS	Potencia del motor
DELUXE +	®
Dessic/Dr	Afectación filtro desecador de frenado
Direc/Ste	Afectación filtro hidráulico de dirección
DONALDSON	Montaje sistema DONALDSON
Eau/Cool	Afectación filtro de agua del circuito de refrigeración del motor
FIBRE/FIBER	Filtro con media filtrante de fibra de vidrio
FILETE/GEWINDE	Filtro con rosca
FREIN/BREMSE	Filtro para sistema de frenado
Gasoil	Afectación filtro de gasoil
GO	Filtro para depósito de gasoil
H:352 MM	Altura del filtro : 352mm
HYD	Filtro para depósito hidráulico
Hydraulic	Afectación filtro hidráulico
HST	Filtro para transmisión hidrostática
IN LINE	Filtro en línea sobre tubería
INT+EXT	Filtro interior + filtro externo
KLEENOIL	®
LINDE	®
LONG LIFE	De larga duración
LOW PROFILE +	®
LS	®
MANN	®
MEC	Filtro para caja de cambios manual
MOT/ENG	Filtro para motor
->MOT 516450	Hasta el número de motor 516450
MOT 516451->	Desde el número de motor 516451
MOT.MAKE	Marca del motor
MOT.TYPE	Tipo del motor
O: 98 MM	Diámetro del filtro : 98mm
Oil/Oel	Afectación filtro de aceite

CODE	DESCRIPTION
OPT.LS ECO	®
OPTION BY-COOL	®
OPTION ISC	®
OPTION LS	®
OU/ODER	O - varios mantajes posibles
PDF AV/FRONTPTO	Filtre para toma de fuerza delantera
Pilot	Afectación filtro hidráulico de pilotaje
PPE	Filtro de bomba
PREF/VORF	Pre filtro
PRESSION/DRUCK	Filtro de presión
PRIM	Filtro primario
REFROID/KUHL	Filtro para sistema de enfriamiento
RELEV/HAUB	Filtro para sistema de elevación
RESERVOIR/TANK	Filtro en el depósito
RETOUR/RUCK	Filtro de retorno
REVERSHIFT	®
REXROTH	®
SANS PPE/OHNE PPE	Montaje sin bomba
SANS/OHNE CLIM/KLIM	Montaje sin aire acondicionado
SAUER	®
SECON	Filtro secundario
SERIE No	Número de serie del vehículo
Trans/Get	Afectación filtro hidráulico de transmisión
TURBO	filtro para turbo
TYPE CARR.	Especificaciones del vehículo
TYPE MACH.	Tipo de máquina
VACUUM SENSOR	Sensor de Vacío
VGT	Turbo de geometría variable
VISSE/SCHR	filtro blindado intercambiable
X3	Cantidad de filtros por montaje



IT ANNOTAZIONI

CODE	DESCRIPTION
+	Il montaggio necessita parecchi filtri
ADDIT/ZUSATZ	Filtro montato in opzione dal costruttore
Aera/Vent	Affettazione filtro sfiato ventilazione
Air/Luft	Affettazione filtro a aria
Air1/Luft	Affettazione filtro a aria primario
Air2/Luft	Affettazione filtro a aria secondario
ANNEE/YEAR	Anno fabbricazione della macchina
ASP/SAUGFILT	Filtro montato in aspirazione
AVEC/MIT BY-PASS	Filtro attrezzato di una valvola by-pass
AVEC/MIT KLIM	Filtro per montaggio con climatizzazione
AVEC/MIT PREF/VORF	Filtro ad aria con prefiltro ciclonico
AVEC/MIT TURBO	Filtro per montaggio su un motore turbo
BACT	Filtri abitacolo antibatterici
BH/OILBADLUFT	Filtro ad aria a bagno d'olio
BV 16	Filtro per cambio a 16 rapporti
BV 24	Filtro per cambio a 24 rapporti
BY-PASS	Filtro montato sul circuito by-pass
C.A/A.K	Filtro carbone attivo
CAB SPACIAL	®
Cabin air	Affettazione filtro abitacolo
CART/EINS	Filtro tipo elemento montato dentro un tino
CCLS	®
CHAUF/HEINZUNG	Filtro per sistema di riscaldamento
CLIM/KLIM	Filtro per sistema di climatizzazione
COMP	Filtro per compressore
CREP/SAUGFILT	Crepina d'aspirazione
CV/HP/PS	Potenza del motore
DELUXE +	®
Dessic/Dr	Affettazione filtro essiccatore freni
Direc/Ste	Affettazione filtro idraulico di direzione
DONALDSON	Montaggio sistema DONALDSON
Eau/Cool	Filtro a acqua del sistema di raffreddamento motore
FIBRE/FIBER	Filtro con il media in fibra di vetro
FILETE/GEWINDE	Filtro con filetto
FREIN/BREMSE	Filtro per sistema di frenaggio
Gasoil	Affettazione filtro a gasolio
GO	Filtro per serbatoio gasolio
H:352 MM	Altezza del filtro: 352mm
HYD	Filtro per serbatoio idraulico
Hydraulic	Affettazione filtro idraulico
HST	Filtro per trasmissione idrostatica
IN LINE	Filtro montato in ligna sulla condotta
INT+EXT	Filtro interno + filtro esterno
KLEENOIL	®
LINDE	®
LONG LIFE	Lunga durata
LOW PROFILE +	®
LS	®
MANN	®
MEC	Filtro per cambio meccanico
MOT/ENG	Filtro per motori
->MOT 516450	Fino al numero motore 516450
MOT 516451->	A partire del numero motore 516451
MOT.MAKE	Marca del motore
MOT.TYPE	Tipo del motore
O: 98 MM	Diametro del filtro : 98mm
Oil/Oel	Affettazione filtro ad olio

CODE	DESCRIPTION
OPT.LS ECO	®
OPTION BY-COOL	®
OPTION ISC	®
OPTION LS	®
OU/ODER	Oppure-possibilità di montaggi diversi
PDF AV/FRONTPTO	Filtro per presa di forza a l'avanti
Pilot	Affettazione filtro idraulico di pilotaggio
PPE	Filtro della pompa
PREF/VORF	Prefiltro
PRESSION/DRUCK	Filtro di pressione
PRIM	Filtro primario
REFROID/KUHL	Filtro per sistema di raffreddamento
RELEV/HAUB	Filtro per sistema di sollevamento
RESERVOIR/TANK	Filtro dentro il serbatoio
RETOUR/RUCK	Filtro di ritorno
REVERSHIFT	®
REXROTH	®
SANS PPE/OHNE PPE	Montaggio senza la pompa
SANS/OHNE CLIM/KLIM	Montaggio senza climatizzazione
SAUER	®
SECON	Filtro secondario
SERIE No	Numero di serie del veicolo
Trans/Get	Affettazione filtro idraulico di trasmissione
TURBO	Filtro per turbo
TYPE CARR.	Specificazione del veicolo
TYPE MACH.	Tipo macchina
VACUUM SENSOR	Indicatore di depressione
VGT	Turbo con geometria variabile
VISSE/SCHR	Filtro avvitato
X3	Quantità di filtri per il montaggio

RO COMENTARII

CODE	DESCRIPTION
+	Montarea necesită mai multe filtre
ADDIT/ZUSATZ	Filtru montat de constructor opțional
Aera/Vent	Ventilație
Air/Luft	Filtru aer
Air1/Luft	Filtru aer primar
Air2/Luft	Filtru aer secundar
ANNEE/YEAR	Anul de fabricație al mașinii
ASP/SAUGFILT	Filtru montat la aspirație
AVEC/MIT BY-PASS	Filtru echipat cu o supapă by-pass
AVEC/MIT KLIM	Filtru pentru climatizare
AVEC/MIT PREF/VORF	Filtru de aer cu prefiltru ciclonic
AVEC/MIT TURBO	Filtru pentru motoarele turbo
BACT	Filtru polen antibacterian
BH/OILBADLUFT	Filtru de aer pentru baie de ulei
BV 16	Filtru pentru cutie de viteze 16 rapoarte
BV 24	Filtru pentru cutie de viteze 24 rapoarte
BY-PASS	Filtru montat pe circuitul by-pass
C.A/A.K	Filtru cu carbon activ
CAB SPACIAL	®
Cabin air	Filtru cabina
CART/EINS	Filtru de tip element ce se montează într-o cuvă
CCLS	®
CHAUF/HEINZUNG	Filtru pentru sistemul de încălzire
CLIM/KLIM	Filtru pentru sistemul de climatizare
COMP	Filtru pentru compresor
CREP/SAUGFILT	Filtru de aspirație
CV/HP/PS	Puterea motorului
DELUXE +	®
Dessic/Dr	Filtru uscător
Direc/Ste	Filtru hidraulic de direcție
DONALDSON	Montarea sistemului DONALDSON
Eau/Cool	Filtru lichid răcire
FIBRE/FIBER	Filtru din fibra de sticlă
FILETE/GEWINDE	Filtru cu filet
FREIN/BREMSE	Filtru pentru sistemul de frânare
Gasoil	Filtru motorina
GO	Filtru pentru rezervor combustibil
H:352 MM	Înălțimea filtrului : 352 mm
HYD	Filtru pentru rezervor hidraulic
Hydraulic	Filtru hidraulic
HST	Filtru hidrostatic pentru transmisie
IN LINE	Filtru în linie pentru conducere
INT+EXT	Filtru interior + filtru exterior
KLEENOIL	®
LINDE	®
LONG LIFE	Long life
LOW PROFILE +	®
LS	®
MANN	®
MEC	Filtru pentru cutia de viteze mecanică
MOT/ENG	Filtru pentru motoare
->MOT 516450	Până la numărul de motor 516450
MOT 516451->	De la numărul de motor 516451
MOT.MAKE	Marca motorului
MOT.TYPE	Tipul motorului
O: 98 MM	Diametrul filtrului : 98 mm
Oil/Oel	Filtru ulei

CODE	DESCRIPTION
OPT.LS ECO	®
OPTION BY-COOL	®
OPTION ISC	®
OPTION LS	®
OU/ODER	SAU - mai multe montări posibile
PDF AV/FRONTPTO	Filtru pentru front
Pilot	Filtru caseta direcție
PPE	Pompa de filtrare
PREF/VORF	Prefiltru
PRESSION/DRUCK	Filtru de presiune
PRIM	Filtru primar
REFROID/KUHL	Filtru pentru sistemul de răcire
RELEV/HAUB	Filtru pentru sistemul de ridicare
RESERVOIR/TANK	Filtru în rezervor
RETOUR/RUCK	Filtru de retur
REVERSHIFT	®
REXROTH	®
SANS PPE/OHNE PPE	Montare fără pompă
SANS/OHNE CLIM/KLIM	Montare fără aer condiționat
SAUER	®
SECON	Filtru secundar
SERIE No	Număr de serie al autovehiculului
Trans/Get	Filtru transmisie
TURBO	Filtru pentru turbo
TYPE CARR.	Specificații vehicul
TYPE MACH.	Tip mașină
VACUUM SENSOR	Senzor de vacum
VGT	Turbo cu geometrie variabilă
VISSE/SCHR	Filtru cu filet
X3	Numărul de filtre de montaj



CODE	DESCRIPTION
+	Montaż wymaga wielu filtrów
ADDIT/ZUSATZ	Filtr zainstalowany przez konstruktora opcjonalnie
Aera/Vent	Przeznaczenie filtra przewietrzania / wentylacji
Air/Luft	Przeznaczenie filtra powietrza
Air1/Luft	Przeznaczenie filtra powietrza pierwotnego
Air2/Luft	Przeznaczenie filtra powietrza wtórnego
ANNEE/YEAR	Rok produkcji maszyny
ASP/SAUGFILT	Filtr zainstalowany na układzie ssania
AVEC/MIT BY-PASS	Filtr wyposażony w zawór by-pass
AVEC/MIT KLIM	Filtr do montażu w wersji z klimatyzacją
AVEC/MIT PREF/VORF	Filtr powietrza z filtrem wstępnym cyklonowym
AVEC/MIT TURBO	Filtr do montażu na silniku turbo
BACT	Filtr kabinowy antybakteryjny
BH/OILBADLUFT	Filtr powietrza olejowy
BV 16	Filtr do skrzyni biegów 16 przełożeń
BV 24	Filtr do skrzyni biegów 24 przełożeń
BY-PASS	Filtr zainstalowany na obwodzie by-pass
C.A/A.K	Filtr z węglem aktywnym
CAB SPACIAL	®
Cabin air	Przeznaczenie filtra kabinowego
CART/EINS	Filtr do instalacji w zbiorniku
CCLS	®
CHAUF/HEINZUNG	Filtr do układu ogrzewania
CLIM/KLIM	Filtr do układu klimatyzacji
COMP	Filtr do kompresora
CREP/SAUGFILT	Filtr siatkowy bezzaworowy
CV/HP/PS	Moc silnika
DELUXE +	®
Dessic/Dr	Osuszacz układu pneumatycznego
Direc/Ste	Filtr hydrauliczny układu kierowniczego
DONALDSON	Montaż systemu DONALDSON
Eau/Cool	Filtr układu chłodzenia silnika
FIBRE/FIBER	Filtr z medium z włókna szklanego
FILETE/GEWINDE	Filtr z gwintem
FREIN/BREMSE	Filtr do układu hamowania
Gasoil	Filtr oleju napędowego
GO	Filtr do zbiornika oleju napędowego
H:352 MM	Wysokość filtra: 352 mm
HYD	Filtr do zbiornika oleju hydraulicznego
Hydraulic	Przeznaczenie filtra hydraulicznego
HST	Filtr do przekładni hydrostatycznej
IN LINE	Filtr szeregowy na przewodzie
INT+EXT	Filtr wewnętrzny + filtr zewnętrzny
KLEENOIL	®
LINDE	®
LONG LIFE	Filtr o przedłużonej żywotności
LOW PROFILE +	®
LS	®
MANN	®
MEC	Filtr skrzyni biegów mechanicznej
MOT/ENG	Filtr silnika
->MOT 516450	Do numeru silnika 516450
MOT 516451->	Począwszy od numeru silnika 516451
MOT.MAKE	Marka silnika
MOT.TYPE	Typ silnika
O: 98 MM	Średnica filtra: 98 mm
Oil/Oel	Filtr oleju

CODE	DESCRIPTION
OPT.LS ECO	®
OPTION BY-COOL	®
OPTION ISC	®
OPTION LS	®
OU/ODER	LUB – wiele możliwych montażu
PDF AV/FRONTPTO	Filtr przedniego wału odbioru mocy
Pilot	Filtr hydrauliczny układu sterowania
PPE	Filtr pompy
PREF/VORF	Filtr wstępny
PRESSION/DRUCK	Filtr ciśnienia
PRIM	Filtr pierwotny
REFROID/KUHL	Filtr do układu chłodzenia
RELEV/HAUB	Filtr do układu podnośnika
RESERVOIR/TANK	Filtr w zbiorniku
RETOUR/RUCK	Filtr powrotny
REVERSHIFT	®
REXROTH	®
SANS PPE/OHNE PPE	Montaż bez pompy
SANS/OHNE CLIM/KLIM	Montaż bez klimatyzacji
SAUER	®
SECON	Filtr wtórny
SERIE No	Numer seryjny pojazdu
Trans/Get	Filtr hydrauliczny przekładni
TURBO	Filtr układu turbosprężarki
TYPE CARR.	Specyfikacja pojazdu
TYPE MACH.	Typ maszyny
VACUUM SENSOR	Wskaźnik podciśnienia
VGT	Turbosprężarka o zmiennej geometrii
VISSE/SCHR	Filtr wkręcany
X3	Ilość instalowanych filtrów

INDEX

N° HIFI	PAGES	N° HIFI	PAGES	N° HIFI	PAGES	N° HIFI	PAGES
AB BDG01	167	INR 040503 M	157	SA 12921	79	SA 7060	77, 78
AB BDG02	167	JR 068520262 B	151	SA 12922	72, 88	SA 7062	72
AB BDW01	167	JR 110720353 B	20	SA 13990	13, 14, 15, 16, 25, 104, 106	SA 7063	77, 78
AB BRW01	167	JR 129770353 B	20	SA 14008	17, 31, 104, 106	SA 7076	88
AB BRW02	167	KD 70322	16, 17, 19, 24, 32	SA 14010	15, 17, 25, 29, 32, 102, 104, 107	SA 7534	50, 51, 52, 53, 54
AB BRW03	167	KD 70436	16, 18, 19, 32	SA 14017	13, 14, 16, 17, 25, 31, 104	SA 7545	54, 55
AB BRW04	167	KIT PLREV70	151	SA 14019	14, 25, 104	SA 7548	55, 56, 57
AB CDG01	167	KIT PLREV90	151	SA 14085	17, 31, 104	SA 7551	87
AB CSW01	167	KJ 74003	14	SA 14472	17, 31, 104	SA 7553	94
AB CSW02	167	KN 70416	19, 32	SA 14503	102	SA 7554	95
AB CSW03	167	KN 70434	18, 19	SA 14504	102	SA 7555	61, 64, 65, 90
AB CSW04	167	MO 3006	15	SA 1452	77, 88	SA 7559	72
AB FEC01	167	MO 3254	28	SA 14531	17, 29	SA 7781	84
AB FEC02	167	MO 3916	36	SA 14580	18, 32	SA 7782	86
AB FEG01	167	MO 5302	18	SA 1481	78	SA 7783	84
AB FEG02	167	MO 7001	19, 32	SA 160028	18	SA 7784	77
AB FEW01	167	MO 7327	18	SA 16074	61, 90	SA 7785	80
AB FEW02	167	N 20001000 PA	127	SA 16120	13, 23	SA 7788	80
AB FEW03	167	N 20001000 PB	127	SA 16121	13, 23	SA 7790	80
AB FEW04	167	N 20001000 PC	127	SA 16122	13, 23, 25	SA 7793	95
AB HYFVRAC01	167	N 20001000 PE	127	SA 16127	13, 23	SA 7795	90
AB HYFVRAC02	167	N 20001000 PF	127	SA 16165	79	SA 7796	72, 75
AB KTG20	169	N 20001000 PG	127	SA 16229	13, 18, 25, 31	SA 7797	80
AB KTG50	169	N 20001000 PI	127	SA 16265	13, 18, 25	SA 7799	92
AB KTG70	169	N 20001000 PJ	127	SA 16359	18, 32	SA 7800	80
AB KTG800	169	N 20001000 PK	127	SA 16414	19	SA 7801	72
AB RLB01	167	N 20001000 PM	127	SA 16460	19	SA 7803	66, 67, 93
AB RLB02	167	N 20001000 PN	127	SA 16472	19, 32	SA 7804	95
AB RLB03	167	N 20001000 PO	127	SA 16474	12, 22	SA 7806	80
AB RLG01	167	N 20001000 PQ	127	SA 16508	19, 32	SA 7808	59, 60, 83, 86
AB RLG02	167	N 20001000 PR	127	SA 16554	20, 38	SA 7809	95
AB SFG01	167	N 20001000 PS	127	SA 16658	18, 19	SA 7810	95
AB SFG02	167	N 20001000 PU	127	SA 16776	19, 32	SA 7812	64, 91
AB TPG01	167	N 20001000 PV	127	SA 16777	19, 32	SA 7813	78
AB TPG02	167	N 20001000 PW	127	SA 17019	17	SA 7814	70, 95
AB TPG03	167	N 20M02000 SB	126	SA 17094	102, 106, 107	SA 7816	95
AB TPW01	167	N 20M02000 SD	126	SA 17100	13, 25	SA 7817	80
AB TPW02	167	N 20M02000 SE	126	SA 17224	102, 106	SA 7818	95
BE 212	42	N 20M02000 SL	126	SA 17278	16, 17, 19, 25, 33	SA 7819	80
BE 215	42, 43, 52, 53, 54, 72, 76	N 20M02000 SN	126	SA 17281	14, 15, 16, 18, 25, 33	SA 7823	80
BE 4051	80, 94	N 20M02000 SQ	126	SA 17321	13, 14, 25	SA 7827	80
BE 5	88	N 40M02000 SA	126	SA 17440	12, 23	SA 7828	78
CR 30	48	NN 4414 GSGP	103, 106, 107	SA 17446	19, 33	SA 7829	80
CR 30/3	48	OA 1067	102, 105	SA 190460	114, 115, 117, 118, 120	SA 7834	84
DAR 11132 Z	156	OA 1086	102, 105	SA 190461	114, 115, 117, 118, 120	SA 7844	93
DAR 12832 Z	156	OA 1105	103, 105, 107	SA 190464	114, 115, 117, 118, 120	SA 7850	93
DAR 12850 Z	156	OA 3415	102, 105	SA 19119	17, 29	SA 7854	93
DAR 24550 Z	156	OD 4000	102, 106, 107	SA 19131	102, 105	SA 7857	93
DAR 54599 ZD	156	OT 2014	102, 107	SA 19146	102, 104, 105	SA 7859	95
EZ 03009	102	OT 2049	102, 107	SA 19149	102, 105	SA 7860	95
EZ 06832	19	PL 1633	169	SA 19197	102, 105	SA 7861	95
EZ 16070	102, 106	PLA 5000	155	SA 19382	102, 106	SA 7875	95
EZ 20000	102, 105	RT 1	78	SA 19415	19, 33	SA 7876	95
EZ 20070	102, 106	RT 2	70, 94	SA 19416	20, 33	SA 7879	93
EZ 20270	102, 106	RT 6	18, 32	SA 19417	19, 20, 33	SA 7881	89
EZ 20470	102, 106	SA 10015	102, 104, 105	SA 2032	69, 94	SA 7883	95
EZ 27070	102, 104, 106	SA 10175	74	SA 20793	79, 87	SA 7886	95
EZ 27100	102, 105	SA 10300 K	20, 24, 38, 104	SA 2089	92	SA 7887	95
EZ 30021	102, 105	SA 10331	73, 79, 88	SA 2095	92	SA 7888	95
EZ 37070	102, 106	SA 10384 K	18, 32, 104	SA 2100	94	SA 7889	80
EZ 41070	102, 106	SA 10716	17, 31	SA 2118	74, 88	SA 7892	84
EZ 45000	102, 104, 105	SA 10793	79, 87	SA 22157	90	SA 7895	84
EZ 50000	102, 105	SA 10920	14, 15, 16, 17, 24, 29, 104	SA 275	87	SA 7896	81
EZ 51000	102	SA 10939	102, 104, 106, 107	SA 28995	57, 62, 63, 64, 84, 90	SA 7898	85
F00303M00	151	SA 11112	74, 87	SA 312	79, 87	SA 7899	85
FS 217	17	SA 11551	20, 25, 104, 106	SA 4019	90	SA 7900	85
FS 268	13, 14, 16, 17, 18, 19, 24	SA 11552	14, 25	SA 4064	79	SA 7901	85
GMN 025S30Z003Z	158	SA 11683 K	18, 20, 32	SA 5048	75	SA 7902	95
GTH 025P10Z003A	150, 151	SA 11723	76	SA 5109 KIT	86	SA 7903	81
GTH 060P10Z003A	150	SA 11752	15, 25, 104	SA 5134	75	SA 7904	81
HF 008182000	151	SA 11763	12, 22	SA 5138	86	SA 7905	81
HF 10007825000	151	SA 11770	20, 21, 37, 38	SA 5144	75	SA 7906	81
HF 1007764000	151	SA 11793	102, 104, 107	SA 5159	75	SA 7907	81
HF 1008772000	151	SA 12035	74	SA 5161	75	SA 7908	81
HF 1010824000	151	SA 12068	61, 62, 90	SA 5162	75	SA 7909	81
HF 1014018000	151	SA 12123	61, 62	SA 5163	72, 75, 88	SA 7910	81
HF 1014019000	151	SA 12156	62, 90	SA 5183	75	SA 7912	81
HF 1014733000	151	SA 12203	66, 67, 92	SA 5184	75	SA 7915	81
HF 1060005966	151	SA 12268	66, 92	SA 521	79	SA 7917	81
HF 1060008096	151	SA 12317	58, 59, 84	SA 6021	75	SA 7918	81
HF 1060008196	151	SA 12336	67, 92	SA 606	13, 14, 16, 25	SA 7919	81
HF 16657000	151	SA 12337	67, 92	SA 7011	88	SA 7920	81
HR 6097	90	SA 12519	16	SA 7056	88	SA 7923	81
HR 7544	54	SA 12832	73, 88	SA 7057	77	SA 7924	81
HR 8956	67					SA 7925	81

N° HIFI	PAGES	N° HIFI	PAGES	N° HIFI	PAGES	N° HIFI	PAGES
SA 7926	82	SH 52019	13, 14, 16, 26	SIR 1007	121	SIR 5008	119
SA 7928	93	SH 52049	17, 30	SIR 1008	121	SIR 8000	114, 121, 122
SA 7930	75	SH 52131	12, 18, 19, 20, 22, 33	SIR 1009	121	SIR 8001	114, 121
SA 7931	82	SH 52209	14, 15, 26	SIR 1011	121	SIR 8002	114, 121
SA 7932	82	SH 52247	16, 26	SIR 1014	121	SIR 8003	114, 121
SA 7935	93	SH 52278	13, 14, 15, 17, 18, 20, 33, 38	SIR 1016	121	SIR 8004	114, 121
SA 7936	96	SH 52291	19, 33	SIR 2002	119, 122	SIR 8005	114, 121
SA 7937	82	SH 52300	14, 26	SIR 2003	119, 122	SIR 8006	121
SA 7938	86	SH 52301	13, 14, 15, 16, 26, 38	SIR 2005	122	SIR 8007	121
SA 7939	85	SH 52309	13, 14, 15, 17, 20, 26, 30, 33, 38	SIR 2006	119, 122	SIR 8008	121
SA 7940	46, 47, 48, 60, 73, 87			SIR 2007	119, 122	SIR 8009	121
SA 7941	94	SH 52330	19	SIR 2009	122	SIR 8010	121
SA 7942	70, 96	SH 52516	17, 18, 30, 33	SIR 2010	122	SIR 8011	121
SA 7953	82	SH 52933	12, 14, 15, 16, 18, 19, 22, 26, 33	SIR 2011	122	SIR 8200	116
SA 7954	82			SIR 2012	122	SIR 8201	116, 122
SA 7955	82	SH 55500	13, 23	SIR 2013	122	SIR 8202	116
SA 7956	72	SH 56191	102, 107	SIR 2014	121	SIR 8203	116
SA 7957	96	SH 56230	102, 106, 107	SIR 2015	121	SIR 8204	116
SA 7958	96	SH 56255	102, 107	SIR 2016	121	SIR 8205	116
SA 7959	96	SH 56361	103, 106, 107	SIR 2018	122	SN 001	12, 24, 30
SA 7960	93	SH 56560	12, 22	SIR 2019	122	SN 017	17, 30
SA 7961	93	SH 56760	20, 37, 38	SIR 2020	122	SN 037	17, 30
SA 7962	85	SH 56771	20, 33	SIR 2021	122	SN 039	20, 26, 30, 35, 38
SA 7963	85	SH 56775	13, 18, 26, 32, 33	SIR 2022	121	SN 066	15, 16, 27, 102, 107
SA 7964	85	SH 62250	102	SIR 3000	117, 121	SN 090	14, 15, 20, 27, 35
SA 7965	85	SH 62305	14, 15, 16, 17, 26	SIR 3001	117, 121	SN 1146	14, 27
SA 7966	82	SH 63061	12, 24, 150	SIR 3002	117, 121	SN 1147	27, 102, 107
SA 7967	82	SH 63063	150	SIR 3003	116, 117, 119, 122	SN 1205	20, 21, 37, 38
SA 7968	82	SH 63066	150	SIR 3004	116, 117, 119, 122	SN 1212	13, 24, 39
SA 7969	82	SH 63071	18, 20, 33	SIR 3005	116, 117, 119, 122	SN 1251	14, 15, 27, 39
SA 7970	82	SH 63076	12, 22	SIR 3006	116, 117, 119, 122	SN 1276	14, 15, 27
SA 7971	84, 90	SH 63077	150	SIR 3007	116, 117, 119, 122	SN 185	20, 21, 37, 38
SA 7972	68, 94	SH 63161	12, 17, 19, 20, 24, 30, 31, 37, 38	SIR 4001	116, 119, 121, 122	SN 194	20, 37
SA 7973	85			SIR 4002	116, 121	SN 20106	63, 91
SA 7974	78	SH 63166	20	SIR 4003	116, 121	SN 20759	72, 77, 78, 89, 94
SA 7975	72, 88	SH 63182	150	SIR 4004	116, 119, 121, 122	SN 21581	61, 91
SA 7976	72, 89	SH 63183	150	SIR 4005	116, 121	SN 24632	62, 91
SA 7977	88, 96	SH 63201	19, 34	SIR 4007	116, 121	SN 25025	12
SA 7979	42, 76	SH 63203	17, 31	SIR 4008	116, 121	SN 25027	61, 91
SA 7982	72, 84, 89	SH 63612	18, 34	SIR 4009	116	SN 25090	12
SA 7984	88	SH 63700	150	SIR 4011	116, 121	SN 25098	12
SA 7985	88	SH 63701	150	SIR 4013	114, 115, 116, 118, 120	SN 25135	12
SA 7986	78	SH 63711	150	SIR 4014	114, 115, 116, 118, 120	SN 268	13, 14, 16, 27, 38
SA 7989	77, 78	SH 64033	102, 107	SIR 4015	114, 115, 116, 118, 120	SN 30036	19
SA 807	89	SH 64179	14, 15, 16, 17, 26	SIR 4016	114, 115, 116, 118, 120	SN 30040	19
SA 8138	42, 73	SH 64184	20, 21, 37, 38	SIR 4017	114, 115, 117, 118, 120	SN 327	14, 17, 18, 19, 20, 27, 31, 35, 38
SA 8953	42, 73	SH 64527	20, 21, 37, 38	SIR 4018	115, 117, 118, 120	SN 35012	16
SA 8955	65, 91	SH 64753	20, 21, 37, 38	SIR 4019	115, 117, 118, 120	SN 40094	157
SA 8962	71, 96	SH 65014	17	SIR 4020	115, 117, 118, 120	SN 40114	157
SA 8963	70	SH 66542	12, 22	SIR 4030	114, 115, 116, 118, 120	SN 40181	157
SA 8964	70	SH 70041	103	SIR 4031	114, 115, 116, 118, 120	SN 40221	157
SA 8965	69, 70	SH 70501	18, 34	SIR 4046	114, 115, 116, 118, 120	SN 40247	157
SA 8966	69, 70, 96	SH 74004	17, 30	SIR 4047	114, 115, 116, 118, 120	SN 40258	157
SA 8967	69, 96	SH 74019	17, 30	SIR 4048	114, 115, 116, 118, 120	SN 40512	13, 24
SA 8968	68, 69	SH 74052	17, 30	SIR 4049	114, 115, 116, 118, 120	SN 40514	12, 18, 22, 35
SA 8969	68	SH 74121	12, 22	SIR 4050	114, 115, 116, 118, 120	SN 40529	13, 18, 27, 32
SA 8970	62, 91	SH 74156 SP	13, 18, 24, 34	SIR 4051	114, 115, 116, 118, 120	SN 40602	13, 15, 16, 18, 24, 27, 32
SA 8971	60, 87, 88	SH 74159 SP	13, 18, 26	SIR 4052	114, 115, 116, 118, 120	SN 40606	13, 15, 16, 24, 27
SA 8972	60, 87	SH 74169 SP	13, 14, 26	SIR 4053	114, 115, 116, 118, 120	SN 40607	157
SA 8973	59, 85	SH 74186 SP	14, 15, 16, 17, 18, 19, 26, 34	SIR 4054	114, 115, 116, 118, 120	SN 40627	157
SA 8974	59, 67, 85	SH 74187 SP	18, 34	SIR 4055	114, 115, 116, 118, 120	SN 40650	16, 27
SA 8975	59, 67, 93	SH 74193	18, 19, 34	SIR 4056	114, 115, 117, 118, 120	SN 40678	19, 35
SA 8976	58, 59, 85	SH 74226	18	SIR 4057	114, 115, 117, 118, 120	SN 40679	19, 35
SA 8977	57	SH 74248 SP	12, 22	SIR 4058	114, 115, 117, 118, 120	SN 4070	21, 39
SA 8978	56, 82	SH 74373	18, 19, 34	SIR 4113	114, 115, 116, 118, 120	SN 40705	14, 27
SA 8979	55, 57, 82	SH 74400 SPV	19, 34	SIR 4114	114, 115, 116, 118, 120	SN 40706	14, 27
SA 8980	55	SH 74518	19, 34	SIR 4115	114, 115, 116, 118, 120	SN 40718	19
SA 8981	55, 82	SH 75004	18, 19, 34	SIR 4116	114, 115, 116, 118, 120	SN 40736	16
SA 8982	54	SH 75004 V	18, 19, 34	SIR 4117	114, 115, 117, 118, 120	SN 40772	61, 91
SA 8984	52, 53, 55, 58, 76, 82, 84	SH 75014	20, 34	SIR 4129	114, 115, 116, 118, 120	SN 40811	157
SA 8985	51, 76	SH 75030	20, 34	SIR 4130	114, 115, 116, 118, 120	SN 5019	12, 15, 20, 22, 27, 37, 38
SA 8987	50, 65, 69, 70, 73, 92, 96	SH 75046	20, 34	SIR 4146	114, 115, 116, 118, 120	SN 5020	20, 37
SA 8988	47, 48, 49, 73	SH 75062	20, 34	SIR 4149	114, 115, 116, 118, 120	SN 5038	12, 13, 15, 21, 22, 27, 39
SA 8989	46, 50, 54, 72, 73, 78, 79	SH 75079	17, 18, 30, 34	SIR 4150	114, 115, 116, 118, 120	SN 5052	12, 13, 15, 21, 22, 27, 39
SA 8990	46, 73	SH 75160	18, 34	SIR 4152	114, 115, 116, 118, 120	SN 5074	12, 20, 22, 35
SA 8991	47, 48, 60, 73, 88	SH 75212	19, 34	SIR 4153	114, 115, 116, 118, 120	SN 5269	12, 15, 23, 27
SA 8992	63, 91	SH 75212 V	19, 34	SIR 4155	114, 115, 116, 118, 120	SN 5297	20, 35
SA 8993	52, 76	SH 75353	19, 35	SIR 4156	114, 115, 117, 118, 120	SN 532	20
SA 8994	61, 62, 91	SH 76855	150	SIR 4158	114, 115, 117, 118, 120	SN 55002	12, 23
SA 8995	57, 61, 62, 63, 64, 65, 91	SH 77013	17, 30	SIR 4300	119	SN 55021	157
SA 8996	82	SH 77250	15, 26	SIR 4302	119	SN 55022	157
SA 8998	82	SH 77254	16, 17, 26	SIR 4303	119	SN 55023	157
SA 8999	96	SH 77255	15, 16, 26	SIR 4304	119	SN 55024	157
SAO 085012	17, 30	SH 77256	13, 14, 15, 16, 17, 26	SIR 4305	119	SN 55025	157
SAO 16799	14	SH 77260	17	SIR 4306	119	SN 55081	157
SAO 5119	18, 33	SH 77821	151	SIR 4307	119	SN 55084	157
SAO 5351	19, 33	SH 84018	12, 22	SIR 4308	119	SN 55085	157
SAO 5369	16, 17, 25	SIR 1000	121	SIR 4309	119	SN 55418	18, 19, 35
SD 70322	13	SIR 1001	121	SIR 4310	119	SN 55429	12, 18, 22, 35
SD 70380	14, 16, 25	SIR 1002	121	SIR 4311	119	SN 55438	19, 35
SD 70382	16, 25	SIR 1003	121	SIR 4313	119	SN 565	17, 31
SD 70466	19	SIR 1004	121	SIR 5005	119	SN 70103	17, 30
SFE 0002	114, 115, 117, 118, 120	SIR 1005	121	SIR 5006	119	SN 70141	15, 16, 17, 18, 19, 28, 35
SH 52007	18, 20, 33	SIR 1006	121	SIR 5007	119		

N° HIFI	PAGES	N° HIFI	PAGES	N° HIFI	PAGES
SN 70142	17, 18, 28, 30, 35	SO 6956	83	TCO 503	18, 37
SN 70146	13, 28	SO 6957	46, 47, 48, 49, 50, 73	TCO 508	18, 37
SN 70154	13, 14, 15, 18, 20, 28, 35	SO 6959	83, 86	TCO 732	12
SN 70160	13, 15, 16, 18, 20, 28, 35, 102, 107	SO 6960	47, 86	WE 2069	17, 29, 31
SN 70186	18, 35	SO 6961	72, 77, 90	WE 2071	12, 14, 15, 23
SN 70201	12	SO 6962	75, 83, 92	WE 2073	14, 15, 23
SN 70238	17, 28	SO 6963	74	WE 2074	12, 23
SN 70283	18, 35	SO 6964	77, 80	WE 2075	13, 24
SN 70284	19	SO 6965	72, 76, 77	WE 2076	13, 15, 16, 24, 29
SN 70399	19, 36	SO 6966	78, 83	WE 2104	12, 15, 23
SN 70421	18, 19, 36	SO 6967	54, 61, 74, 78, 79, 84, 87, 90, 91	WE 2106	15, 29
SN 80028	12	SO 6968	84, 90	WE 2142	20, 37
SN 909030	18, 36	SO 6969	42, 44, 45, 60, 70, 71, 73, 87, 96	Y RK30063	22, 28, 36
SN 909110	13, 16, 17, 28	SO 6971	87		
SN 912010	12, 22	SO 6972	86		
SN 916010	18, 19, 36	SO 6973	75, 91		
SN 920202	158	SO 6974	85, 93		
SN 920210	158	SO 6975	65, 66, 67, 84, 93		
SN 920230	158	SO 6976	85		
SN 920249	158	SO 6977	42, 43, 52, 53, 76, 92		
SN 925210	158	SO 6978	68, 70, 94, 96		
SN 926030	12	SO 6979	47, 59, 66, 67, 73, 86, 93		
SO 008	17, 30	SO 6980	56, 61, 83, 91		
SO 040	17, 21, 28, 30, 36, 39	SO 6981	51, 76		
SO 053	17, 31	SO 6982	72, 75, 84		
SO 059	79	SO 6983	52, 58, 76, 92		
SO 10008	13	SO 6985	46, 59, 60, 62, 63, 74, 87, 91		
SO 10011	12, 13, 15, 16, 23, 24, 28, 39	SO 6986	42, 43, 50, 51, 52, 53, 54, 58, 60, 72, 76, 77, 83, 94		
SO 10020	13, 24	SO 6988	46, 54, 60, 65, 66, 73, 78, 86, 93, 96		
SO 10046	13, 14, 18, 28, 32	SO 6989	65, 68, 69, 70, 88, 96		
SO 10052	12, 18, 19, 22, 36	SO 6990	70, 71, 78, 89, 92, 97		
SO 10056	15, 28	SO 6991	97		
SO 10067	17, 28	SO 6992	97		
SO 10179	16	SO 6993	55, 56, 57, 83		
SO 11044	79	SO 6994	46, 54, 55, 56, 57, 59, 63, 65, 79, 83, 86, 91, 93		
SO 11092	19	SO 6995	58, 86		
SO 11159	12	SO 6996	93		
SO 128	77	SO 6997	94		
SO 129	74, 77, 79, 90	SO 6998	74, 94		
SO 131	77, 79, 87, 89, 90, 92	SO 6999	42, 47, 48, 49, 54, 60, 66, 67, 73, 74, 77, 78, 86, 87, 94		
SO 180	12, 23, 38	SO 7001	14, 20, 29, 36		
SO 242	14, 17, 19, 20, 28, 31, 36, 39	SO 7034	15, 29		
SO 25529	77	SO 7040	75		
SO 287	17, 31	SO 7050	75		
SO 3000	12, 13, 14, 15, 23, 24, 28	SO 7053	74, 76		
SO 3320	14, 15, 16, 28	SO 7055	18, 36		
SO 3327	15, 16, 17, 18, 28, 31, 36, 102, 107	SO 7063	13, 29		
SO 3328	20, 21, 37, 39	SO 7081	13, 18, 20, 29, 36		
SO 3335	80, 89	SO 7082	14, 15, 29		
SO 3345	14, 21, 28, 39	SO 7095	59, 60, 62, 63, 74, 83, 87, 92		
SO 3349	14, 28	SO 7099	13		
SO 3376	20, 36	SO 7110	52, 72, 74, 76, 87, 89		
SO 3640	12, 15, 23, 29	SO 7139	15, 16, 17, 19, 29, 36		
SO 3730	20, 36	SO 7162	57		
SO 4017	12, 23	SO 7238	19, 36		
SO 404	17, 31	SO 7266	18, 19, 36		
SO 4105	14, 15, 29	SO 734	12, 14, 15, 23, 29		
SO 4126	74, 89	SO 777	18		
SO 416	17, 31	SO 8003	74, 89		
SO 417	17, 31	SO 8023	89		
SO 515	18, 19, 20, 36	SO 8148	61		
SO 517	20, 37	SO 8550	12		
SO 6066	85	SO 8590	12, 24		
SO 6076	74, 83, 85, 89, 94, 96	SO 8996	79, 84		
SO 6205	12	SO 9001	76, 89		
SO 646	13, 14, 16, 29	SO 941	20		
SO 667	20, 37, 39	SUPBIGBAGARL	169		
SO 691	20, 37	SVL 03000 VIG	168		
SO 6923	68	SVL 04000 VIA	168		
SO 6924	57, 84	SVL 04000 VIG	168		
SO 6925	93	SVL 05000 TOU	168		
SO 6926	83	SVL 05000 VIW	168		
SO 6928	89	SVP 01000 ATA	168		
SO 6929	56, 57, 83	SVP 01000 DIA	168		
SO 6930	79	SVP 02000 ATA	168		
SO 6935	76, 92	SVP 02000 DIA	168		
SO 6936	96	SVP 02000 SEP	168		
SO 6937	80	T 1636	42, 58, 59, 73, 76, 77, 80, 86		
SO 6938	87	T 501	42, 46, 54, 55, 57, 60, 65, 67, 73, 78, 84, 86, 90		
SO 6939	94	T 59	44, 46, 57, 58, 59, 60, 61, 62, 63, 64, 65, 69, 70, 71, 74, 78, 83, 86, 92, 97		
SO 6941	86	T 60	102		
SO 6942	43, 91	T 600	60, 61, 92		
SO 6943	43, 63, 64, 65, 91	T 8304	83, 86		
SO 6944	89	T 8307	64, 68, 97		
SO 6945	54, 77	T 9337	94		
SO 6947	75	TB 1390	13, 16, 17, 19, 29, 36		
SO 6948	57, 83				
SO 6949	80				
SO 6951	51, 76				
SO 6953	88				
SO 6955	49, 59, 67, 69, 70, 71, 73, 83, 85, 89, 90, 94, 96				



RECOMMANDATIONS GÉNÉRALES GENERAL ADVICES ALLGEMEINE ERKLÄRUNGEN



RECOMMANDATIONS GÉNÉRALES

FR

Les renseignements contenus dans ce catalogue sont diffusés à titre indicatif à notre clientèle et sont aussi exacts que possible. Cependant, des erreurs d'impression ainsi que des modifications constructeurs peuvent apparaître après édition de ce document. En cas de doutes, nous vous prions de vous adresser à nous-mêmes ou à nos représentants. Tout nouveau catalogue annule les éditions précédentes. Toute reproduction, ne serait-ce que partielle, est interdite sans notre autorisation écrite.

GENERAL ADVICES

EN

All informations contained in this catalogue are given as an indication to our customers, and are as accurate as possible. Despite all our efforts, some printing mistakes can occur, as well as constructor modifications done after publication of this document. In case of doubts, please contact us or our sales representative directly. Every new catalogue supersedes previous editions. No part of this publication may be reproduced in any way without our prior written consent.

ALLGEMEINE ERKLÄRUNGEN

DE

Die Angaben in diesem Kataloge sind unverbindlich. Für Änderungen der Filterausrüstung durch die Fahrzeug- und Motorenhersteller oder durch die Hersteller von Filtererzeugnissen anderer Marken, übernehmen wir keinerlei Gewähr. Es können auch Druckfehler auftreten. In Zweifelsfällen bitten wir um Rückfrage bei uns, oder unseren Vertretern. Mit Erscheinen des neuesten Kataloges verlieren alle früheren Ausgaben ihre Gültigkeit. Für diese Unterlagen behalten wir uns alle Rechte vor. Nachdruck, auch auszugsweise, ist nur mit unserer vorherigen schriftlichen Genehmigung gestattet.

RECOMENDACIONES GENERALES

ES

Informaciones dadas en este catálogo lo son a título de indicación y están tan exactas como posible y se ha puesto el máximo cuidado en su elaboración. Sin embargo, no se descarta la posibilidad de algún error de impresión, ni también los cambios que se practican a veces de parte de los fabricantes, posteriores a nuestra publicación. En caso de duda, le rogamos sirvanse llamarnos directamente con motivo de comprobarlo. Con cada nueva publicación, se pierden validez todas las ediciones anteriores. La reproducción total o parcial no está permitida sin nuestra previa autorización escrita.

RACCOMANDAZIONI GENERALI

IT

Le informazioni contenute in questo catalogo sono date a titolo indicativo ai nostri clienti e sono le più scrupolose possibili. Tuttavia alcuni errori di stampa o alcuni cambiamenti da parte dei costruttori possono apparire dopo la pubblicazione di questo documento. In caso di qualsiasi dubbio vogliate ulteriormente verificarlo con noi. Ad ogni nuova pubblicazione perdono validità le edizioni precedenti. Ristampe anche parziali non sono ammesse senza una nostra autorizzazione scritta.

RECOMANDĂRI GENERALE

RO

Informațiile conținute în acest catalog sunt oferite clienților noștri cu titlu informativ și sunt cât se poate de exacte. Cu toate acestea, este posibil să apară erori de tipărire și modificări efectuate de constructori după editarea prezentului document. Dacă aveți îndoieli, vă rugăm să ne contactați pe noi sau pe reprezentanții noștri. Orice catalog nou anulează edițiile precedente. Orice reproducere, chiar și parțială, este interzisă fără autorizația noastră scrisă.

ZALECENIA OGÓLNE

PL

Treści zawarte w niniejszym katalogu mają charakter informacyjny i są możliwie jak najdokładniejsze. Nie wyklucza się jednak błędów w druku lub zmian wprowadzonych przez producentów po publikacji niniejszego dokumentu. W razie wątpliwości prosimy o kontakt z nami lub naszymi przedstawicielami. Każdy nowy katalog unieważnia poprzednie edycje. Wszelkie powielanie, nawet częściowe, jest zabronione bez wcześniejszej pisemnej zgody z naszej strony.

Horizontal lines for form input.



